



www.Rodem.com | (800) 543-7312

Fast, Effective Impact Cleaning

Alfa Laval TJ TZ-67 Rotary Jet Head - Portable

Application

The Toftejorg TZ-67 rotary jet head provides 3D indexed impact cleaning over a defined time period. It is automatic and represents a guaranteed means of achieving quality assurance in tank cleaning. The device is suitable for processing, storage and transportation tanks and vessels between 50 and 500 m³. Used in breweries, food and dairy processes and many other industries, the Toftejorg TZ-67 is particularly well-suited to portable applications where high impact is required.

Working principle

The flow of the cleaning fluid makes the nozzles perform a geared rotation around the vertical and horizontal axes. In the first cycle, the nozzles lay out a coarse pattern on the tank surface. The subsequent cycles gradually make the pattern more dense, until a full pattern is reached after 8 cycles.



TECHNICAL DATA

Lubricant: Self-lubricating with the cleaning fluid
Standard Surface finish: Ra 0.5µm exterior
Max. throw length: 7 - 17 m
Impact throw length: 4 - 10 m

Pressure

Working pressure: 3 - 12 bar
Recommended pressure: 5 - 6.5 bar

Cleaning Pattern

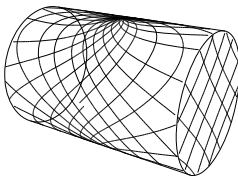

First cycle

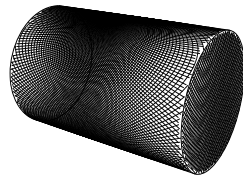

Full pattern

The above drawings show the cleaning pattern achieved on a cylindrical horizontal vessel. The difference between the first cycle and the full pattern represents the number of additional cycles available to increase the density of the cleaning.

Certificates

2.1 material certificate and ATEX.



PHYSICAL DATA

Materials

316L (UNS S31603), PTFE, PVDF, PEEK, ETFE, TFM

Temperature

Max. working temperature: 95°C
Max. ambient temperature: 140°C

Weight: 6 kg

Connections

Standard thread: 1 1/2" Rp (BSP) or NPT, male

Options

- Electronic rotation sensor to verify 3D coverage
- Hose saddle, deck cover plate, hose winch, hose, etc. are available.

Caution

Do not use for gas evacuation or air dispersion.

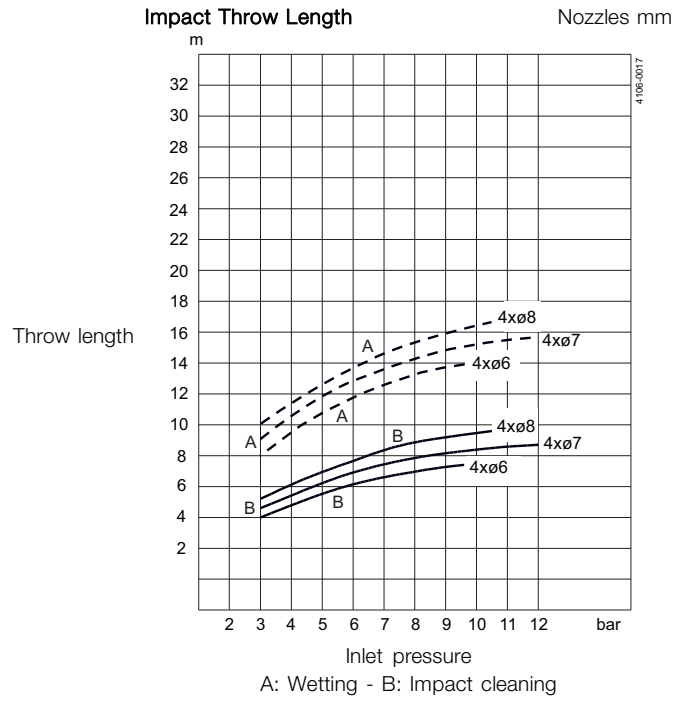
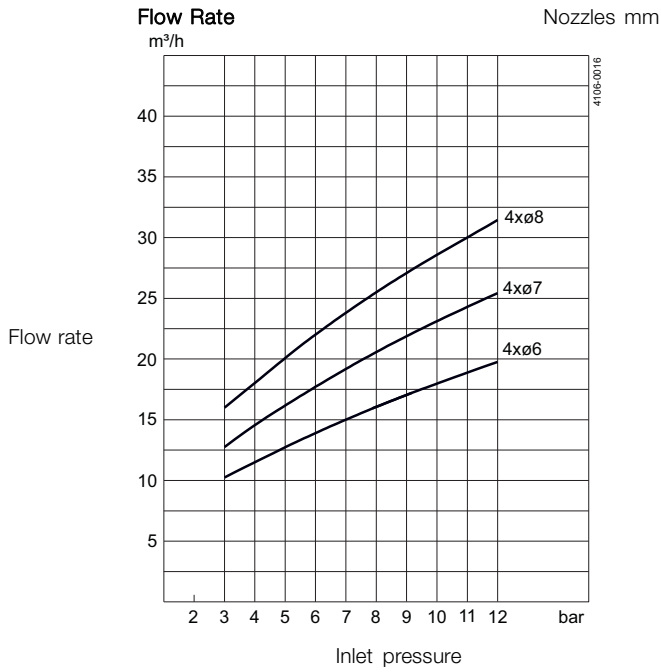

Dimensions (mm)

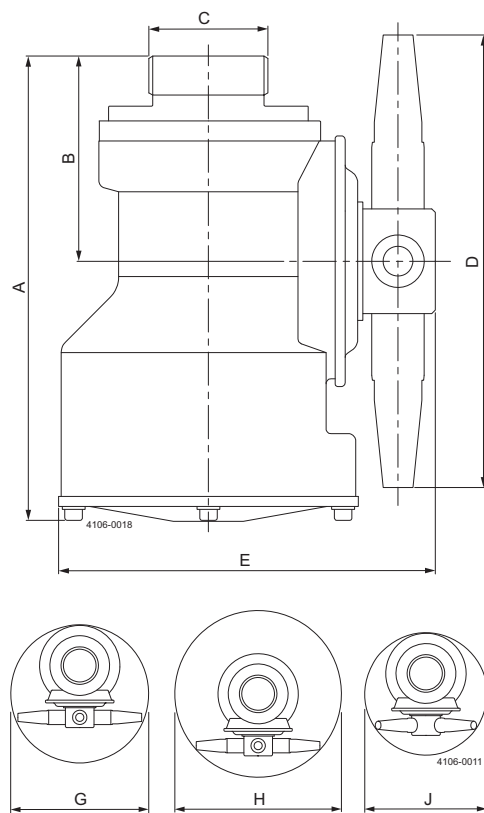

Cleaning Time, Complete Pattern

Min. RPM of machine body

Nozzles mm

PTM (Pattern time minutes)

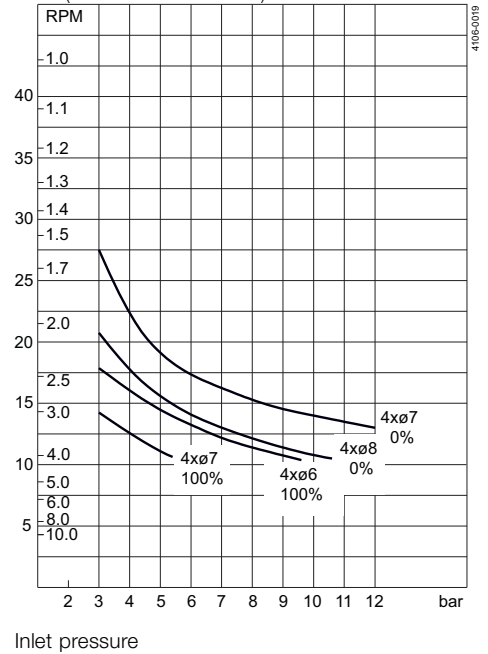

A	B	C	D	E	G	H	J
186	82	1½" BSP / 1½" NPT	204	152	ø216	ø264	ø180

Standard Design

The choice of nozzle diameters can optimise jet impact length and flow rate at the desired pressure. Complete portable systems can comprise a four-wheel carriage and hose winch. As standard documentation, the Toftejorg TZ-67 can be supplied with a "Declaration of Conformity" for material specifications.

TRAX simulation tool

TRAX is a unique software that simulates how the Toftejorg TZ-67 performs in a specific tank or vessel. The simulation gives information on wetting intensity, pattern mesh width and cleaning jet velocity. This information is used to determine the best location of the tank cleaning machine and the correct combination of flow, time and pressure to implement.

A TRAX demo containing different cleaning simulations covering a variety of applications can be used as reference and documentation for tank cleaning applications. A TRAX simulation is free and available upon request.

Wetting Intensity

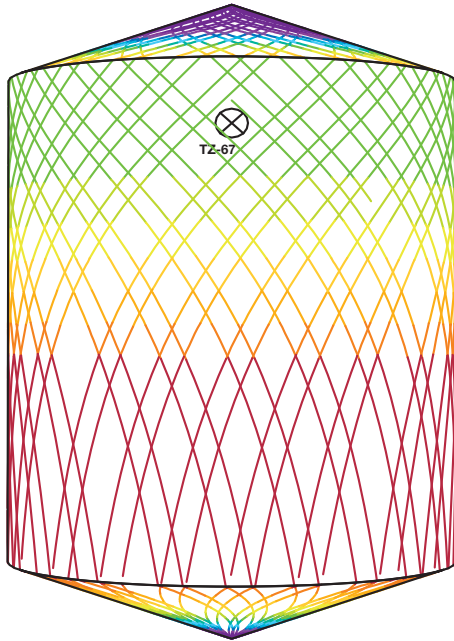
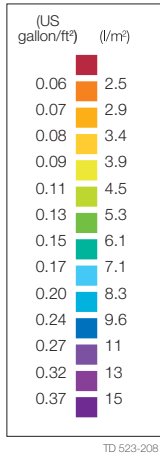

D2.5m H6m, Toftejorg TZ-67, 4 x ø6 mm Time = 3.5 min.,
Water consumption = 727 l

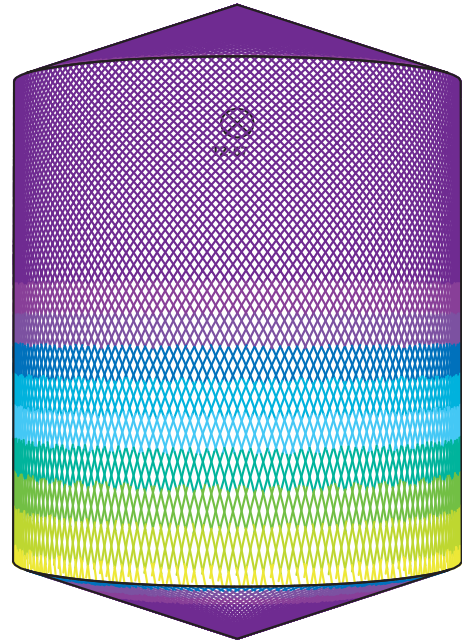

D2.5m H6m, Toftejorg TZ-67, 4 x ø6 mm Time = 14.7 min.,
Water consumption = 3097 l

Alfa Laval reserves the right to change specifications without prior notification. ALFA LAVAL is a trademark registered and owned by Alfa Laval Corporate AB.

ESE00322EN 1507

© Alfa Laval

How to contact Alfa Laval

Contact details for all countries are continually updated on our website. Please visit www.alfalaval.com to access the information direct.