



Simply Unique

Unique 7000 Series Y-body

General Information

The Unique 7000 Series is an innovative new generation of Tri-Clover® single seat valves that are designed to meet the highest process demands of hygiene and safety. They're built on a well-proven, platform from an installed base of more than one million valves.

Application

The Unique 7000 is a sanitary air-operated seat valve with a flexible design. The Y-body version offers a straight through product flow path and is designed for gentle product treatment. The main use for these valves is in applications involving high viscosity or large particulates.

Working principle

The valve is remote-controlled by means of compressed air. It has few and simple moveable parts which results in a very reliable valve with low maintenance cost.

Standard design

The Unique 7000 valve is designed to deliver years of reliability and performance you've come to expect with all Tri-Clover® products. The TR2 seat ring with enhanced CIP capabilities and hygiene comes standard with all Unique 7000 series valves. The standard actuator comes with a five year warranty. The Unique 7000 Y-body valve sizes range from 2" to 4".

Other valves in the same basic design

- Single seat valve.
- Reverse acting valve.
- Long stroke valve.
- Manually operated valve.
- Aseptic valve.

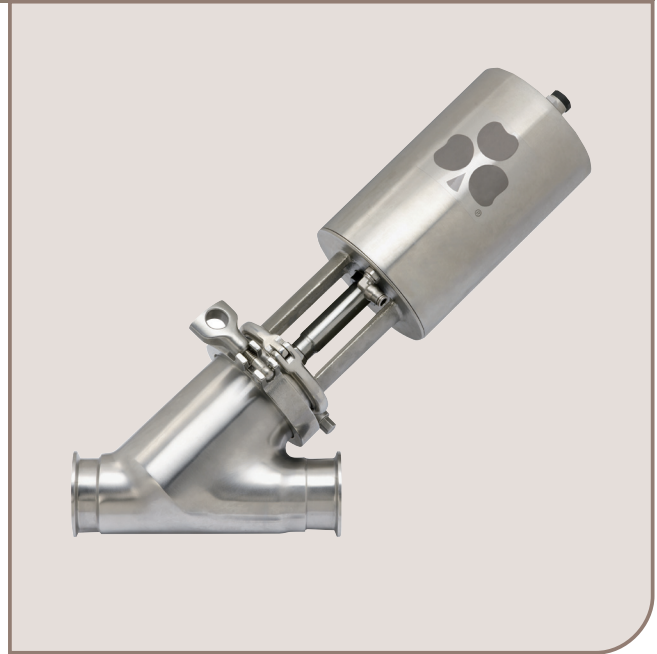

Unique 7000 Series Y-Body

Pressure drop/capacity diagrams

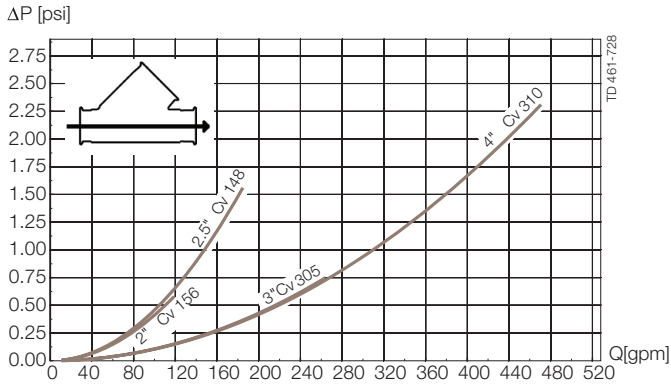

For the diagrams the following applies:

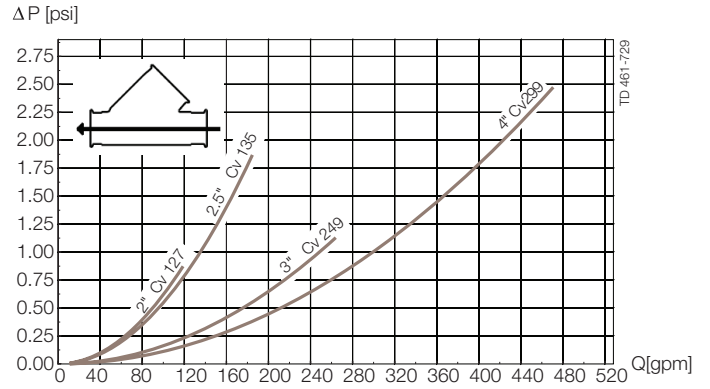

Medium: Water (68° F/20° C)

Measurement: In accordance with VDI2173

Pressure data for Unique 7000 Series valves Y-body

Table 1

Max. pressure in psi without leakage at the valve seat

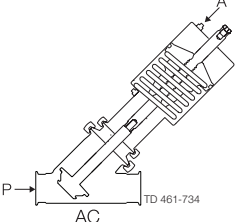
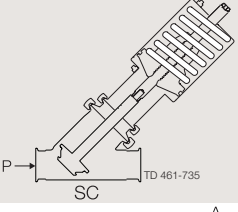
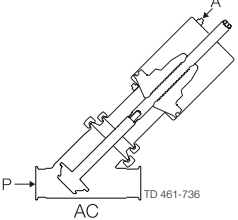
Actuator / Valve body combination and direction of pressure	Air pressure [psi]	Plug position	Valve size			
			2"	2½"	3"	4"
 AC TD 461-734	87	NO	71	40	55	31
 SC TD 461-735		NC	64	35	55	31
 AC TD 461-736	87	A/A	145	103	137	78

A = Air
P = Product pressure

AC = Air closes
SC = Spring closes

Table 2

Max. pressure in psi against which the valve can open.

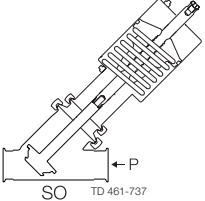
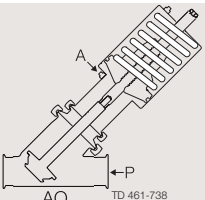
Actuator / Valve body combination and direction of pressure	Air pressure [psi]	Plug position	Valve size			
			2"	2½"	3"	4"
 SO TD 461-737		NO	133	74	94	54
 AO TD 461-738	87	NC	142	79	95	54

A = Air
P = Product pressure

AO = Air opens
SO = Spring opens

Dimensions

	Nominal Size			
	2"	2.5"	3"	4"
A	17.32	17.95	22.05	24.41
C	7.88	9.25	10.38	12.63
ID	1.86	2.36	2.86	3.81
F ₁	1.97	1.97	2.64	2.64
H	4.53	4.53	6.14	6.14
Weight (lb)	18.9	24.5	41.1	59.7

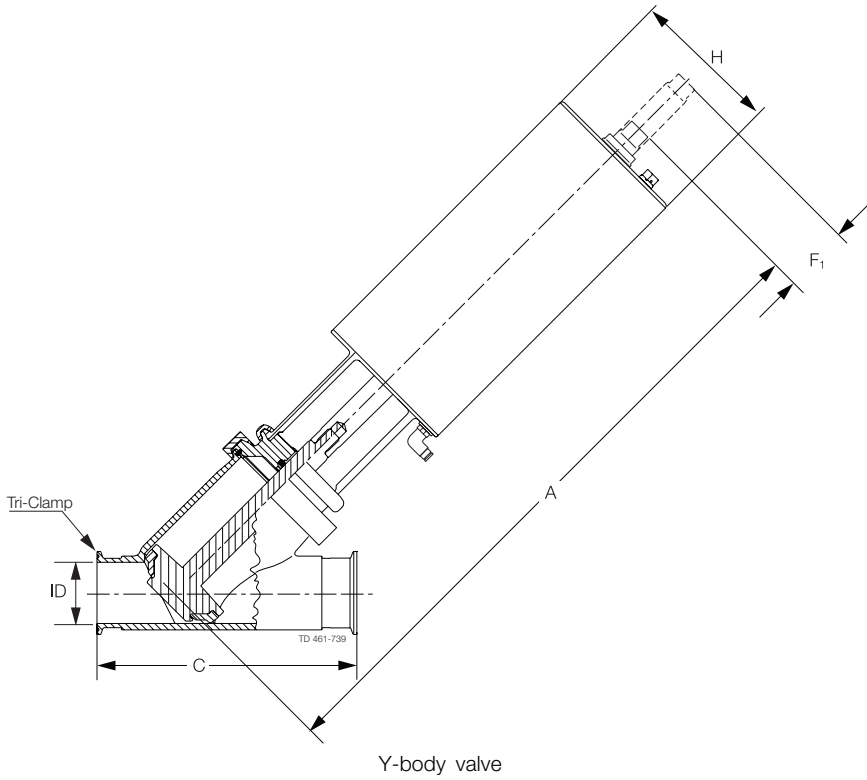

Caution, opening/closing time:

Opening/closing time will be effected by the following:

- The air supply (air pressure).
- The length and dimensions of the air hoses.
- Number of valves connected to the same air hose.
- Use of single solenoid valve for serial connected air actuator functions.
- Product pressure.

Air Connections Compressed air:

R 1/8" (BSP), internal thread.

Technical data

Max. product pressure (depending on valve specifications):145 psi (1000 kPa (10 bar)).
Min. product pressure:Full vacuum.
Temperature range:14°F to +284°F (EPDM).
Air pressure:72.5 to 101.5 psi (500 to 700 kPa (5 - 7 bar)).

Actuator function

- Pneumatic downward movement, spring return.
- Pneumatic upward movement, spring return.
- Pneumatic upward and downward movement (A/A).

Size	Air Consumption (In ³ free air) for one stroke	
	2"-2½"	3"-4"
NO and NC	3.39 x air pressure [psi]	8.52 x air pressure [psi]
A/A	5.79 x air pressure [psi]	16.2 x air pressure [psi]

Materials

Product wetted steel parts:AISI 316L (internal Ra < 32 μ inch)
Other steel parts:AISI 304
Plug seal:PTFE (TR2)
Other product wetted seals:EPDM (standard)
Optional product wetted seals:HNBR/NBR or FPM
Other seals:NBR

Options

- Control and Indication: ThinkTop, ThinkTop Basic and GreenTop.
- Product wetted seals in HNBR/NBR or FPM.

Ordering

Please state the following when ordering:

- Size.
- Actuator function: NC, NO or A/A.
- Options.

Note!

For further details, see instruction ESE00583.

Description Code Unique 7000

Valve function			Body							Actuation		Stem/elastomer		Misc.
1	2	3	4	5	6	7	8	9	10	11	12	13	14	
7610	012	S	M	1	H40	1	S	S	S	T	Y	S	04	

- 1 Model**

Code	
-- Unique 7000	7610
-- Unique 7000 Aseptic	8610
-- Unique 7000 Tangential Outlet (Horizontal Mounting)	7620
-- Unique 7000 Tank Outlet (Vertical Mounting)	7630
-- Unique 7000 Regulating	7710
-- Unique 7000 Y-body	7610
- 2 Body style**

Code	
-- Shut-off (2 port)	200
-- Shut-off (3 port)	300
-- Shut-off TR (2 port)	208
-- Shut-off TL (2 port)	207
-- Shut-off TC (3 port)	309
-- Change Over (3 port)	210
-- Change Over (4 port)	220
-- Change Over (4 port)	310
-- Change Over (5 port)	320
-- Shut-off RA (2 port)	011
-- Shut-off RA (3 port)	021
-- Shut-off RA (3 port)	012
-- Shut-off RA (4 port)	022
-- Change Over RA (3 port)	111
-- Change Over RA (4 port)	211
-- Change Over RA (4 port)	121
-- Change Over RA (4 port)	112
-- Change Over RA (5 port)	122
-- Change Over RA (5 port)	221
-- Change Over RA (5 port)	212
-- Change Over RA (6 port)	222
-- Tankoutlet 1 port	001
-- Tankoutlet 2 port	002
-- Tankoutlet RA (1 port)	010
-- Tankoutlet RA (2 port)	020
-- Y-body	900
- 3 Build in dimension**

Code	
-- Standard	S
-- 700 Series Build Dimensions (Center-Face; shut-off only)	C
- 4 Connection Ports - all identical**

Code	
-- Weld ends - all ports	W
-- Tri-Clamp - all ports	M
-- Threaded Bevel Seat - all ports	T

Connection Ports - mixed

Code	
-- Mixed connection types	S
-- Weld end	W
-- Tri-Clamp	M
-- Iso Clamp	I
-- Union SMS	S
-- Union DIN	C
-- Din Clamp	D
-- Threaded Bevel Seat	T
-- No port	N
- 5 Surface Finish**

Code	
-- 3A (OD = Dust blast; ID = 32Ra)	1
-- 3A Bright (OD = Bright; ID = 32Ra)	2
-- PC (3A) (OD = Dust blast; ID = 20Ra)	3
-- PL (3A) (OD = Bright; ID = 20Ra)	4
-- PP (3A) (OD = Bright; ID = 15Ra)	5
-- PM (3A) (OD = Bright; ID = 15Ra w/EP)	6
- 6 Size (Port)**

Code	
-- 2-Inch	H20
-- 2½-Inch	H25
-- 3-Inch	H30
-- 4-Inch	H40
- 7 Actuation Mode**

Code	
-- Norm. Open/Spring to open	1
-- Norm. Open/Spring to open (RA)	2
-- Norm. Closed/Spring to close	1
-- Norm. Closed/Spring to close (RA)	2
-- Air to air	3
-- Two-step/Three Position	4
-- Manual	5
- 8 Actuator Stroke**

Code	
-- Standard	S
-- Long Stroke	L
- 9 Actuator Type**

Code	
-- Maintainable	R
-- Semi maintainable	S
- 10 Holding Pressure Capability**

Code	
-- Standard	S
-- High pressure	H
- 11 Stem Type**

Code	
-- Elastomer Plug Seal	S
-- TR/PTFE Plug Seal	T
- 12 Wetted Seal Materials**

Code	
-- EPDM	E
-- HNBR	U
-- FPM (Fluoroelastomer)	Y
- 13 Assembled Valve**

Code	
-- Assembled valve	S
- 14 Top Unit Type**

Code	
ThinkTop digital 0 Solenoid	TA
ThinkTop digital 1 Solenoid	TB
ThinkTop digital 2 Solenoid	TC
ThinkTop ASI 0 Solenoid	TE
ThinkTop ASI 1 Solenoid	TF
ThinkTop ASI 2 Solenoid	TG
ThinkTop DeviceNet 0 Solenoid	TI
ThinkTop DeviceNet 1 Solenoid	TJ
ThinkTop DeviceNet 2 Solenoid	TK
ThinkTop Digital 110V 0 Solenoid	TM
ThinkTop Digital 110V 1 Solenoid	TN
ThinkTop Digital 110V 2 Solenoid	TO
ThinkTop Basic Digital 0 Solenoid	BA
ThinkTop Basic Digital 1 Solenoid	BB
ThinkTop Basic Digital 2 Solenoid	BC
IndiTop digital 0 Solenoid	IT
GreenTop 2 Mech Switches 0 Solenoid	04
GreenTop 2 Prox Switches 0 Solenoid	12
GreenTop 24 VDC 2 Mech Switches 1 Solenoid	18
GreenTop 110 VAC 2 Mech Switches 0 Solenoid	20
GreenTop 24 VDC 2 Prox Switches 1 Solenoid	34
GreenTop 110 VAC 2 Prox Switches 1 Solenoid	36



ESE00565ENUS 0709

The information contained herein is correct at the time of issue,
but may be subject to change without prior notice.

How to contact Alfa Laval

Contact details for all countries
are continually updated on our website.
Please visit www.alfalaval.com to
access the information direct.

 Authorized to carry
the 3A symbol