

# Standard Pump



## Sanitary Pump Models: SP-850SR & SP-850DD

### Description

Standard's Drum Pumps are designed to transfer a variety of materials from 55 gallon drums and tanks. Standard Pump offers several different pumps, each designed for specific applications. Before operating, please confirm that the pump's materials of construction are suitable for the application.

### Unpacking

Cartons should be handled with care to avoid damage from dropping, etc. After unpacking, inspect carefully for any damage that may have occurred during transit. Check for loose, damaged or missing parts.

### General Safety Information

The responsibility for safe assembly, installation, and operation ultimately rests with the operator. Read and understand ALL safety precautions and operating instructions before operation. Careless pump operation can result in serious injury.

1. Before operating the pump, read and understand these operating instructions.
2. The operator should wear suitable protective clothing including the following: face mask, safety shield or goggles, gloves, apron, and safety shoes.
3. Before operating, verify the materials being pumped are compatible with the pump's "wetted components."
4. All Federal, State, and local safety codes should be followed.
5. Verify that the motor voltage corresponds to proper electrical supply.
6. Before plugging motor into power supply, make sure the motor switch is in the OFF position. For Air Motors ensure inlet valve is closed before attaching air line.
7. Before operation, confirm all pump connections are properly tightened.
8. First pump clean water in order to familiarize yourself with the pump's operation, flow rate, discharge pressure and motor speed.
9. Before starting the pump, confirm the discharge hose is securely fastened to the receiving vessel in order to prevent splashing.
10. Never leave pump unattended during operation.
11. Do not submerge the motor in any liquid.
12. When finished using the pump, flush the pump by pumping water or an appropriate cleaning solution. Do not use flammable or combustible cleaning solutions.
13. Never carry the motor by the power cord.
14. Never store pump in container. Always rinse pump thoroughly and hang on wall bracket or ensure pump tube is stored in an upright and vertical position.

### SP-850SR Specifications

| Model          | Immersion Length | Wetted Components |        |                 | Motor Drive Options | Discharge Size  | Max Viscosity cps (mPAS)* | Max Discharge Pressure | Max Flow Rate   | Max Temp        | Inlet Size | Max Solid Size | Duty Cycle   |
|----------------|------------------|-------------------|--------|-----------------|---------------------|-----------------|---------------------------|------------------------|-----------------|-----------------|------------|----------------|--------------|
|                |                  | Tube & Rotor      | Stator | Mechanical Seal |                     |                 |                           |                        |                 |                 |            |                |              |
| SP-850SR-751P  | 39" (1000 mm)    | SS316             | PTFE   | SiC/Viton®/SiC  | SP-ENC              | 1.5" Tri-Clamp® | 30,000                    | 87 psi (6 bar)         | 10 GPM (38 LPM) | 300° F (148° C) | 2" (51 mm) | .25" (6 mm)    | Intermittent |
| SP-850SR-752P  | or 47" (1200 mm) |                   |        |                 | SP-430EX            |                 | 3,000                     | 174 psi (12 bar)       | 9 GPM (34 LPM)  |                 |            |                |              |
| SP-850SR-1851P |                  |                   |        |                 | SP-440EX            |                 | 3,000                     | 87 psi (6 bar)         | 16 GPM (61 LPM) |                 |            |                |              |

\*Pump is intended for intermittent use.

- Notes**
1. Performance is based on using a 900 RPM motor. Reducing motor speed will decrease pump performance.
  2. The SP-850SR Series pump is equipped with a gear reduction unit which reduces the speed of the pump to between 750 and 900 RPM. Therefore, the motor speed must not exceed 16,000 RPM's in order to achieve the proper operating RPM's of the pump.
  3. Performance will vary depending on whether the product being pumped is newtonian (viscosity remains constant regardless of shear) or non-newtonian (viscosity does not remain constant with shearing).
  4. Flow rates based on water. As viscosity increases, the flow rate will decrease.

## Sanitary Pump Models: SP-850SR & SP-850DD

### SP-850SR Motor Specifications

| Model      | Voltage | Amps | Watts | HP  | Phase | Hz    | Enclosure   | Variable Speed | Hazardous Duty | Shipping Weight |
|------------|---------|------|-------|-----|-------|-------|-------------|----------------|----------------|-----------------|
| SP-430EX   | 110V    | 9.1  | 1000  | 1.3 | 1     | 50-60 | EXP (IP54)  | Y              | QPS            | 17 (7,7)        |
| SP-440EX   | 230V    | 4.2  | 1000  | 1.3 | 1     | 50-60 | EXP (IP54)  | Y              | AtEx           | 17 (7,7)        |
| SP-ENC     | 110V    | 8.5  | 825   | 1   | 1     | 50-60 | TEFC (IP54) | N              | N              | 12.7 (5,7)      |
| SP-ENC-V   | 110V    | 8.5  | 825   | 1   | 1     | 50-60 | TEFC (IP54) | Y              | N              | 12.7 (5,7)      |
| SP-ENC-2   | 220V    | 5    | 825   | 1   | 1     | 50-60 | TEFC (IP54) | N              | N              | 12.7 (5,7)      |
| SP-ENC-2-V | 220V    | 5    | 825   | 1   | 1     | 50-60 | TEFC (IP54) | Y              | N              | 12.7 (5,7)      |

### SP-850SR

**⚠ WARNING** *The SP-850SR Series Pump is recommended for intermittent duty use only. (ie., 30 minute intervals with a 10 minute cooling off period). For continuous duty applications, Standard Pump recommends using the SP-850DD Series Pump.*

**⚠ WARNING** *The SP-850SR Series Pump is positive displacement pumps and should never be operated against shut-off elements such as nozzles, valves, etc. DO NOT reduce the discharge line below 1.5" (38 mm). Failure to comply may result in excessive pressure build resulting in serious injury and pump damage.*

**⚠ WARNING** *Do not operate the SP-850SR Series Pump on viscosities greater than the maximum viscosities stated in the specifications table on page 1. Failure to comply will result in premature pump failure.*

**⚠ WARNING** *The SP-850SR Series Pump should not run dry. Running the pump dry will result in serious damage to the mechanical seal and stator of the pump*

#### Assembly (SP-850SR)

1. Remove the pump and motor from packaging.
2. Inspect all contents for damages.
3. Couple the electric motor to the pump using the hex nut (see Figure 1).

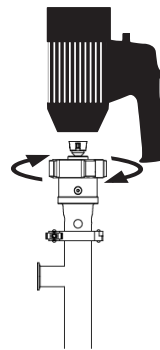

Figure 1

4. First pump clean water in order to familiarize yourself with the pump's operation, flow rate, discharge pressure and motor speed.
5. It is recommended to thoroughly clean and sanitize SP-850SR series pumps before operation (see page 4).
6. Use closed top drum or cover to prevent possible contamination.

#### Operation (SP-850SR)

1. Once the pump is fully assembled and all connections are fastened, insert the pump into the drum or tank (see Figure 2).

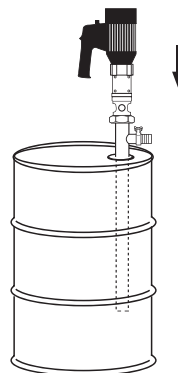



Figure 2

2. It is recommended to attach a suitable hose or pipe to the pump discharge.

**⚠ WARNING** *Make sure the hose meets the pump discharge pressure requirements (SP-850SR-751 or SP-850SR-1851= 87 psi (6 bar)) / (SP-850SR-752= 174 psi (12,1 bar)). It is recommended to use a hose that is rated 4 x the pump discharge pressure. Ex: 87 x 4= 348 psi (24,3 bar).*

3. If you opt to use a hose, fasten the hose to the hose barb with a suitable hose clamp that exceeds the pump discharge pressure.
4. Make sure the speed control knob on the motor is turned to the MIN position (completely counterclockwise).
5. Turn the motor switch to the ON position.
6. Slowly throttle the motor up by turning the speed control knob clockwise.

**⚠ WARNING**  *Do not use these pumps for the transfer of flammable or combustible products or in an environment where flammable or combustible fumes are present unless used in conjunction with Explosion Proof or Air motor as well as proper grounding and bonding wires. Please consult the factory or authorized distributor with any questions regarding installation (see page 7).*

**Maintenance & Disassembly (See page 4)**

## Sanitary Pump Models: SP-850SR & SP-850DD

### SP-850DD Specifications

| Model          | Immersion Length | Wetted Components |        |                 | Motor Drive Options | Discharge Size  | Max Viscosity cps (mPAS)* | Max Discharge Pressure | Max Flow Rate   | Max Temp        | Inlet Size | Max Solid Size | Duty Cycle |
|----------------|------------------|-------------------|--------|-----------------|---------------------|-----------------|---------------------------|------------------------|-----------------|-----------------|------------|----------------|------------|
|                |                  | Tube & Rotor      | Stator | Mechanical Seal |                     |                 |                           |                        |                 |                 |            |                |            |
| SP-850DD-751P  | 39" (1000 mm)    | SS316             | PTFE   | SiC/Viton®/SiC  | Electric & Air      | 1.5" Tri-Clamp® | 100,000                   | 87 psi (6 bar)         | 10 GPM (38 LPM) | 300° F (148° C) | 2" (51 mm) | .25" (6 mm)    | Continuous |
| SP-850DD-752P  | or               |                   |        |                 |                     |                 | 30,000                    | 174 psi (12 bar)       | 9 GPM (34 LPM)  | 300° F (148° C) |            |                |            |
| SP-850DD-1851P | 47" (1200 mm)    |                   |        |                 |                     |                 | 3,000                     | 87 psi (6 bar)         | 16 GPM (61 LPM) | 300° F (148° C) |            |                |            |

- Notes**
- Performance is based on using a 900 RPM motor. Reducing motor speed will decrease pump performance.
  - Performance will vary depending on whether the product being pumped is newtonian (viscosity remains constant regardless of shear) or non-newtonian (viscosity does not remain constant with shearing).
  - Flow rates based on water. As viscosity increases, the flow rate will decrease.

### SP-850DD Motor Specifications

| Model  | HP   | KW  | RPM     | Enclosure | Frame      | Flange   | Air Consumption                    | Airline Size Inches | Shipping Weight |
|--------|------|-----|---------|-----------|------------|----------|------------------------------------|---------------------|-----------------|
| SP-504 | 0.75 | .55 | 750-900 | Washdown  | 90LC       | B14/C140 | N/A                                | N/A                 | 56 (25,5)       |
| SP-524 | 1.5  | 1,1 | 750-900 | Washdown  | 100LC      | B14/C140 | N/A                                | N/A                 | 80 (36,3)       |
| SP-A4  | 2    | 1,5 | 300-900 | N/A       | IEC#72/D71 | B14/C140 | 80 CFM @ 100 psi 37 L/Sec @ 7 Bar  | 3/8"                | 12.0 (5,0)      |
| SP-A6  | 4    | 3,0 | 300-900 | N/A       | IEC#72/D71 | B14/C140 | 130 CFM @ 100 psi 65 L/Sec @ 7 Bar | 1/2"                | 24.0 (11,0)     |
| SP-A8  | 5    | 3,7 | 300-900 | N/A       | IEC#72/D71 | B14/C140 | 170 CFM @ 100 psi 80 L/Sec @ 7 Bar | 1/2"                | 26.0 (12,0)     |

**Note:** For optimum performance when using an air motor make sure proper size air lines are installed.

### SP-850DD

**⚠ WARNING** *The SP-850DD Series Pump is a positive displacement pump and should never operate against shut-off elements such as nozzles, valves, etc. Failure to comply may result in excessive pressure build resulting in serious injury and pump damage.*

**⚠ WARNING** *The SP-850DD Series Pump should not be run dry. Running the pump dry will result in serious damage to the mechanical seal and stator of the pump.*

#### Assembly (SP-850DD)

- Remove the pump and motor from packaging.

- Inspect all contents for damages.
- Couple the motor to the pump. Bolt electric or pneumatic motor to the pump using the hardware provided by the manufacturer (see figure 3).
- It is recommended to thoroughly clean and sanitize SP-850DD series pumps before operation.
- Closed top drum or cover is recommended to prevent possible contamination.
- Motor
  - Electric – make sure motor and plug are wired to proper voltage and direction. Use wiring diagram on nameplate.
  - Air – for optimum performance make sure proper size air line and connection.

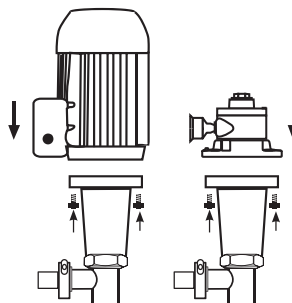
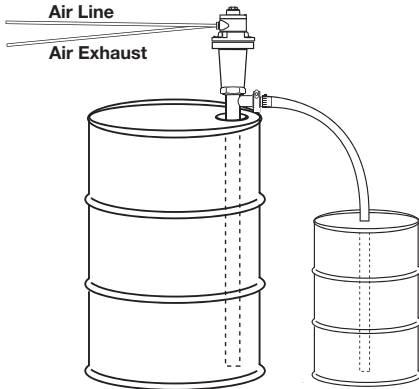

Figure 3

**Sanitary Pump Models: SP-850SR & SP-850DD**

**Assembly (SP-850DD)  
(continued)**



**Note:** Recommend plumbing discharge air away from drum or tank to prevent possible contamination.

**⚠ WARNING** When using an SP-A4FP, SP-A6FP or SP-A8FP motor, Standard Pump recommends the use of a Fliter Lubricator Regulator (FLR) in order to ensure a moisture free supply of air to the motor.

**⚠ WARNING** Do not operate the SP-850DD series pump on viscosities greater than the maximum viscosities stated in the specifications table on page 3. Failure to comply will result in premature pump failure.

**⚠ WARNING** When using an SP-850DD pump in conjunction with an air motor (SP-A4FP, SP-A6FP or SP-A8FP), make sure the air line is connected to the air inlet hole on the left side of the motor as you face the motor. This will insure that the motor turns in a clockwise direction. Use the pump arrow to verify proper direction. If the pump rotates counterclockwise, the internal components will disassemble.

**⚠ WARNING**  Do not use these pumps for the transfer of flammable or combustible products or in an environment where flammable or combustible fumes are present unless used in conjunction with Explosion Proof or Air motor as well as proper grounding and bonding wires. Please consult the factory or authorized distributor with any questions regarding installation (see page 7).

**Operation (SP-850DD)**

1. Once the pump is fully assembled and all connections are fastened, insert the pump into the drum or tank. Pump can be suspended from hoisting system using an optional pump hanger (P/N: 743).

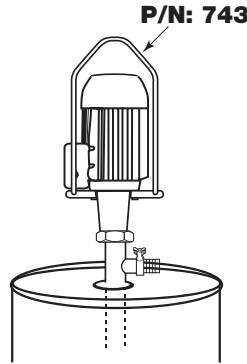

2. It is recommended to attach a suitable hose or pipe to the pump discharge.
3. If you opt to use a hose, fasten the hose to the hose barb with a suitable hose clamp that exceeds the pump discharge pressure.

**⚠ WARNING** Make sure the hose meets the pump discharge pressure requirements (SP-850DD-751 or SP-850DD-1851=87 psi (6 bar)) / (SP-850DD-752=174 psi (12,1 bar)). It is recommended to use a hose that is rated 4 x the pump discharge pressure. Ex: 87 x 4= 348 psi (24,3 bar).

**Maintenance**

**Disassembly / Cleaning Procedures (SP-850SR & SP-850DD)**

4. Remove motor from pump tube. For models SP-850SR: loosen Hex Nut in clockwise rotation (see Figure 3). For models SP-850DD: loosen (4) bolts that attach the pump to the motor (see Figure 4).

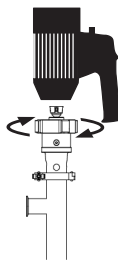

Figure 3

**NOTE:** Remove motor by turning hex nut clockwise

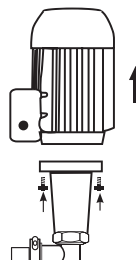

Figure 4

**NOTE:** Remove 4 bolts from motor flange.

5. Remove Tri-Clamp connection (see Figure 5).

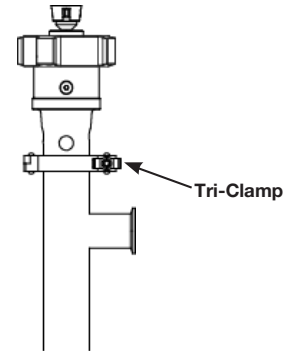

Figure 5

6. Once the Tri-Clamp is removed, remove the outer tube from the drive shaft assembly (see Figure 6).

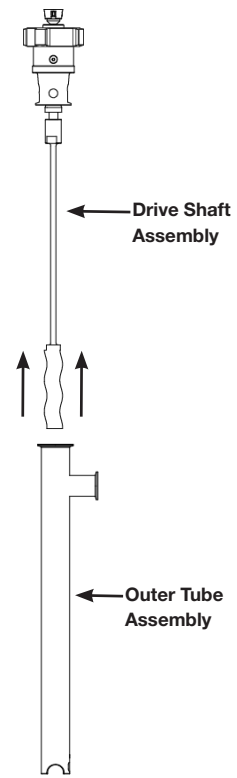

Figure 6

**Sanitary Pump Models: SP-850SR & SP-850DD**

**Disassembly / Cleaning Procedures (continued)**

- Remove stator from outer tube by rotating the stator sleeve clockwise and pulling the stator sleeve and PTFE stator through the bottom of the outer tube (see Figure 7).

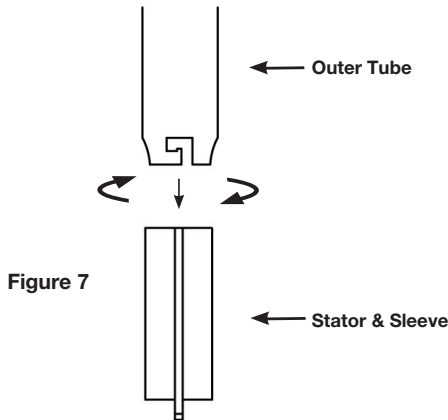

Figure 7

- Remove PTFE stator from stator sleeve (see Figure 8).

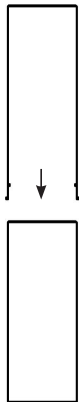

Figure 8

- Insert a small screwdriver (or similar object) through the small hole on the shaft located inside the mechanical seal inspection port (see Figure 9).
- While holding the small shaft still, loosen (counterclockwise) the drive shaft/rotor assembly with a large wrench (see Figure 9).

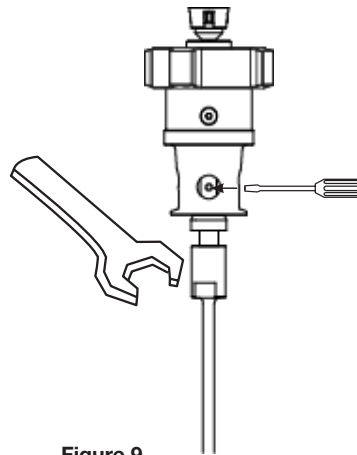

Figure 9

**Mechanical Seal Replacement / Pump Assembly (SP-850SR & SP-850DD)**

- Follow steps 1-9 under the Disassembly / Cleaning Procedures from above.
- The mechanical seal will be exposed in the lower portion of the mechanical seal bushing (see Figure 10).

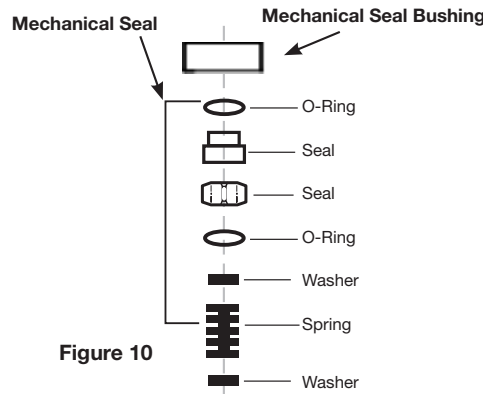

Figure 10

- Remove damaged seal and replace with a new mechanical seal. Use a suitable lubricant on the seals O-rings.

**⚠ WARNING** *Wear gloves when performing seal maintenance. Touching the seal face could cause premature failure.*

- Install mechanical seal bushing into bearing housing and install remainder of mechanical seal.
- Thread drive shaft/rotor assembly onto bearing housing shaft (see Figure 9).
- Insert PTFE stator into stator sleeve (see Figure 8).
- Install stator/stator sleeve in outer tube by aligning the tabs on the sleeve with the grooves on the outer tube, inserting the sleeve and rotating counterclockwise (see Figure 7).
- Apply a suitable lubricant on rotor.
- Place tri-clamp gasket in gasket channel at top end of outer tube.
- Once upper housing and drive shaft/rotor are securely threaded together, insert this assembly into the outer tube (see Figure 6, page 4).
- Ensure that the tabs on the upper housing align with the notches on the flange of the outer tube. This will ensure that the upper housing does not rotate independent of the outer tube during operation.
- Install tri-clamp connecting bearing housing to outer tube (see Figure 5, page 4).
- Reattach motor and resume operation. (SP-850SR: see Figure 3, page 4); (SP-850DD: see Figure 4, page 4).

**Sanitary Pump Models: SP-850SR & SP-850DD**

**SP-850SR Spare Parts Lists**

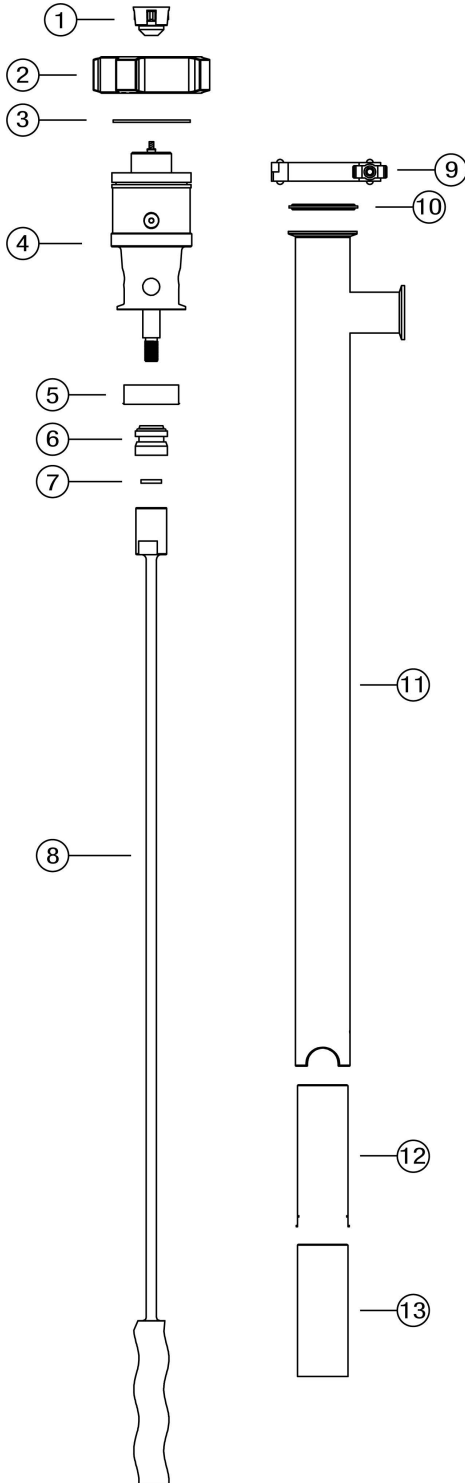

| Ref # | Description                           | P/N  | Qty |
|-------|---------------------------------------|------|-----|
| 1     | Pump Coupling                         | 1004 | 1   |
| 2     | Connection Nut, SS316                 | 8842 | 1   |
| 3     | Snap Ring, SS316                      | 8208 | 1   |
| 4     | Gear Reduction Unit, SS316            | 879  | 1   |
| 5     | Mechanical Seal Bushing, SS316        | 851  | 1   |
| 6     | Mechanical Seal, SIC                  | 703  | 1   |
| 7     | Gasket, PTFE                          | 735  | 1   |
| 8     | Drive Shaft/Rotor Assembly, SS316     |      | 1   |
|       | SP-850SR-751P-39                      | 806  |     |
|       | SP-850SR-751P-47                      | 807  |     |
|       | SP-850SR-752P-39                      | 808  |     |
|       | SP-850SR-752P-47                      | 809  |     |
|       | SP-850SR-1851P-39                     | 810  |     |
|       | SP-850SR-1851P-47                     | 811  |     |
| 9     | Tri-Clamp, SS304                      | 856  | 1   |
| 10    | Tri-Clamp Gasket, Buna                | 855  | 1   |
| 11    | Outer Tube Assembly, SS316            |      | 1   |
|       | SP-850SR-39                           | 804  |     |
|       | SP-850SR-47                           | 805  |     |
| 12    | Stator Sleeve, SS316                  |      | 1   |
|       | SP-850SR-751P-39 & SP-850SR-751P-47   | 865  |     |
|       | SP-850SR-752P-39 & SP-850SR-752P-47   | 866  |     |
|       | SP-850SR-1851P-39 & SP-850SR-1851P-47 | 867  |     |
| 13    | Stator Insert, PTFE                   |      | 1   |
|       | SP-850SR-751P-39 & SP-850SR-751P-47   | 852  |     |
|       | SP-850SR-752P-39 & SP-850SR-752P-47   | 853  |     |
|       | SP-850SR-1851P-39 & SP-850SR-1851P-47 | 854  |     |

**Sanitary Pump Models: SP-850SR & SP-850DD**

**SP-850DD Spare Parts Lists**

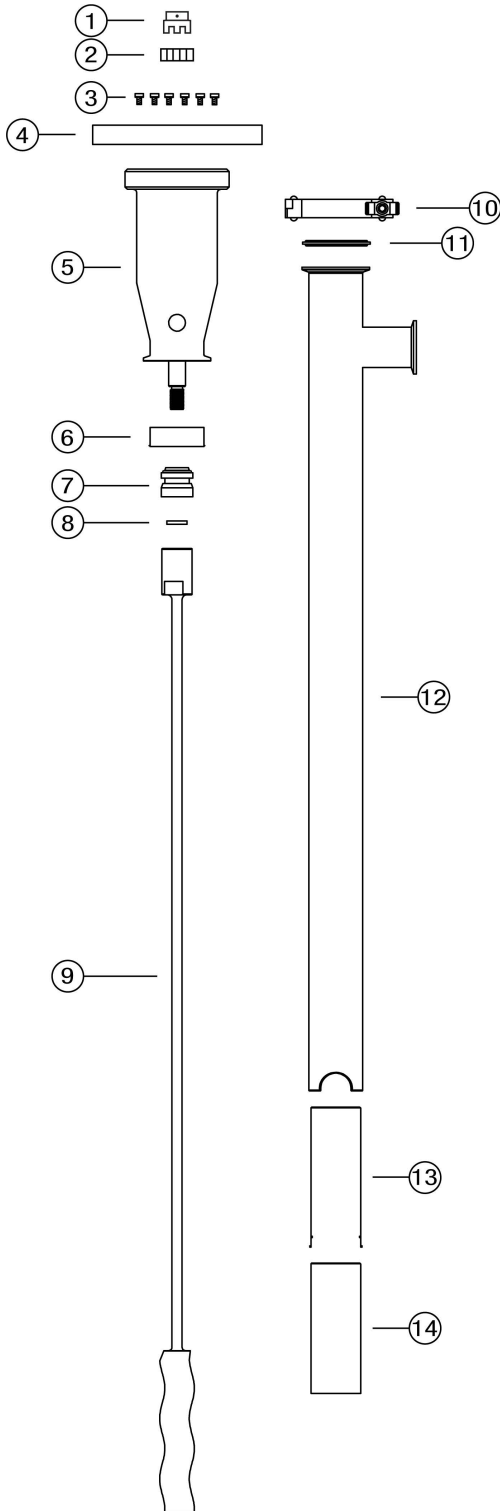

| Ref # | Description                                  | P/N        | Qty |
|-------|--|------------|-----|
| 1     | Motor Coupling (Not Included with Pump Tube) |            | 1   |
|       | SP-504 & SP-A8 Models (24mm)                 | <b>740</b> |     |
|       | SP-A4 Model (14mm)                           | <b>744</b> |     |
|       | SP-A6 Model (19mm)                           | <b>747</b> |     |
|       | SP-524 Models (28mm)                         | <b>746</b> |     |
| 2     | Coupling Insert                              | <b>745</b> | 1   |
| 3     | Flange Bolt, SS304                           | <b>758</b> | 6   |
| 4     | Motor Mount Flange, SS304                    |            | 1   |
| 5     | Bearing Housing Assembly, SS316              | <b>859</b> | 1   |
| 6     | Mechanical Seal Bushing, SS316               | <b>851</b> | 1   |
| 7     | Mechanical Seal, SIC                         | <b>703</b> | 1   |
| 8     | Gasket, PTFE                                 | <b>735</b> | 1   |
| 9     | Drive Shaft/Rotor Assembly, SS316            |            | 1   |
|       | SP-850DD-751P-39                             | <b>806</b> |     |
|       | SP-850DD-751P-47                             | <b>807</b> |     |
|       | SP-850DD-752P-39                             | <b>808</b> |     |
|       | SP-850DD-752P-47                             | <b>809</b> |     |
|       | SP-850DD-1851P-39                            | <b>810</b> |     |
| 10    | Tri-Clamp, SS304                             | <b>856</b> | 1   |
|       | Tri-Clamp Gasket, Buna                       | <b>855</b> | 1   |
| 12    | Outer Tube Assembly, SS316                   |            | 1   |
|       | SP-850DD-39                                  | <b>804</b> |     |
|       | SP-850DD-47                                  | <b>805</b> |     |
| 13    | Stator Sleeve, SS316                         |            | 1   |
|       | SP-850DD-751P-39 & SP-850DD-751P-47          | <b>865</b> |     |
|       | SP-850DD-752P-39 & SP-850DD-752P-47          | <b>866</b> |     |
|       | SP-850DD-1851P-39 & SP-850DD-1851P-47        | <b>867</b> |     |
| 14    | Stator Insert, PTFE                          |            | 1   |
|       | SP-850DD-751P-39 & SP-850DD-751P-47          | <b>852</b> |     |
|       | SP-850DD-752P-39 & SP-850DD-752P-47          | <b>853</b> |     |
|       | SP-850DD-1851P-39 & SP-850DD-1851P-47        | <b>854</b> |     |

## WARRANTY

---

### Three year limited warranty

Standard Pump, Inc. warrants, subject to the conditions below, through either Standard Pump, Inc., its subsidiaries, or its authorized distributors, to repair or replace free of charge, including labor, any part of this equipment which fails within **three years** of delivery of the product to the end user. Such failure must have occurred because of defect in material or workmanship and not as a result of operation of the equipment other than in accordance with the instructions given in this material. Specific exceptions include:

- Consumable items such as motor brushes, bearings, couplings and impellers. (Motor brushes typically have a life span of approximately 250 hours. This will vary with the manner in which the motor is used)

Conditions of exceptions include:

- Equipment must be returned by prepaid carriage to Standard Pump, Inc., its subsidiary or authorized distributor.
- All repairs, modifications must have been made by or with express written permission by Standard Pump, Inc., its subsidiary or authorized distributor.
- Equipment which have been abused, misused, or subject to malicious or accidental damage or electrical surge are excluded.

Warranties purporting to be on behalf of Standard Pump, Inc. made by any person, including representatives of Standard Pump, Inc, its subsidiaries, or its distributors, which do not fall within the terms of this warranty shall not be binding upon Standard Pump, Inc. unless expressly approved in writing by a Director or Manager of Standard Pump, Inc. Information for returning pumps Equipment which has been contaminated with, or exposed to, bodily fluids, toxic chemicals or any other substance hazardous to health must be decontaminated before it is returned to Standard Pump, Inc, or its distributor. A returned goods authorization number (RGA #) issued by Standard Pump, Inc., its subsidiary or authorized distributor, must be included with the returned equipment. The RGA # is required if the equipment has been used. If the equipment has been used, the fluids that have been in contact with the pump and the cleaning procedure must be specified along with a statement that the equipment has been decontaminated.

### STANDARD PUMP

1610 Satellite Blvd. Suite D., Duluth, Georgia 30097 USA  
TOLL FREE 866-558-8611 • Phone 770-307-1003 • Fax 770-307-1009  
info@standardpump.com  
www.standardpump.com