

---

# Instruction Manual

# **RODEM**<sup>®</sup>

PROCESS EQUIPMENT

[www.rodem.com](http://www.rodem.com) 800-543-7312



**ANDERSON-NEGELE**

Instrument Model Number \_\_\_\_\_

Instrument Serial Number \_\_\_\_\_

Anderson Instrument Co. Inc.  
156 Auriesville Road  
Fultonville, NY 12072  
1-800-833-0081  
Fax 518-922-8997

# **DIGITAL REFERENCE THERMOMETER (DART)**



---

# **Table of Contents**

<b>SECTION 1 - DESCRIPTION</b>	<b>PAGE</b>
1.1 General	4
<b>SECTION 2 - INSTALLATION</b>	
2.1 Mechanical	5
2.2 Electrical	5
2.3 QDR – Quick Disconnect Receptacle Wiring	8
<b>SECTION 3 - TESTING PROCEDURES</b>	
3.1 Accuracy	9
3.2 Speed of Response	10
3.3 Additional Tests	10
<b>SECTION 4 - TROUBLESHOOTING</b>	
4.1 Troubleshooting and Repair	12
<b>APPENDICES</b>	
A - Specifications	13
<b>FIGURES</b>	
Figure 1 Dimensional Drawing	6
Figure 2 Power Board	7
Figure 3 Display Board	9
Figure 4 Sensor Wiring Configuration	10

---

## Section 1 - Description

### 1.1 GENERAL

The Digital Reference Thermometer (DRT) was developed as a replacement for the analog Mercury-In-Glass (MIG) thermometers required by the Pasteurized Milk Ordinance (PMO) for verifying pasteurization temperatures. The MIG thermometer has historically been the only acceptable reference due to several criteria inherent in the design. Among these are readability, accuracy, speed-of-response and the fail-safe aspects of MIG thermometers. Each of these criteria has been addressed in the proprietary design of the DRT.

The DRT incorporates a 1/2" LED display with 4 1/2 active digits. This provides a readable display at a much greater distance than the MIG thermometer. In the Fahrenheit mode, 1/10 degree resolution is provided (1/100th in °C) insuring no operator interpolation errors as is possible with the MIG thermometer. The DRT display is housed in a panel or wall mount enclosure for mounting flexibility. It is expected that the thermometer will be located where it can be most easily monitored and checked.

The dual element temperature sensor utilizes 4-wire circuitry, thus providing greater accuracy than conventional 2 or 3 wire sensing elements.

The DRT monitors both sensor signals simultaneously, comparing them electronically to insure they track one another within  $\pm .50^{\circ}\text{F}$  ( $.30^{\circ}\text{C}$ ). If in balance within the prescribed limits, the primary signal is displayed. If outside these limits, the logic circuit causes the display to blank. This provides fail-safe operation comparable to an MIG thermometer. In addition, separate watchdog circuitry monitors for proper sensor wiring. An "open" or "short" circuit also causes a blank display until wiring is repaired.

The DRT is designed to provide a response characteristic which meets the existing regulations. Based on repeated testing of a number of units, the average response is about three seconds for the standard test. See Section 3.2 for outline of the procedures.

Diagnostic indicator lights for power, inhibit and failure modes are provided within the instrument for troubleshooting purposes.

---

## Section 2 - Installation

### 2.1 MECHANICAL

Refer to Figure 1, page 5 for dimensions and mounting schematics. Choose a location for the display which allows the thermometer to be viewed from the control panel and/or the Safety Thermal Limit Recorder. The case may be wall or panel mounted. Protect the display from direct hose-down conditions.

The thermometer will be shipped with the specified length of pre-wired cable. If disconnected for ease of installation, reconnect by referring to Figure 2, page 6. Allow enough excess cable at the sensor end to allow the probe to reach the floor for testing purposes. In addition, if enough excess cable is available to bring the probe within sight of the indicator for testing, the procedure will be simplified. Any excess cable at the sensor should be tightly coiled, tie-wrapped and hung in a protected position.

### 2.2 ELECTRICAL

***Electrical code requirements and safety standards should be observed.***

Bring 100 VAC power, with ground through the 1/2" penetration in the base of the instrument. Route the power lead to the lower left corner of the case. Connect the three leads as shown in Figure 2, page 6.

If the sensor input leads have been disconnected for external routing, bring the cable back through the rubber grommet and reconnect by color code as shown in Figure 2, page 6.

Shortening the cable is acceptable but care should be taken to insure none of the leads are "nicked" when stripping insulation. Tinning of all leads is recommended.

After wiring is completed, position the F/C switch for Fahrenheit or Centigrade operation. The switch is located on the display board just to the right of the display.

***Note: If RTD is replaced, reconnect cable by color code, see Figure 4, page 8.***

FIGURE 1

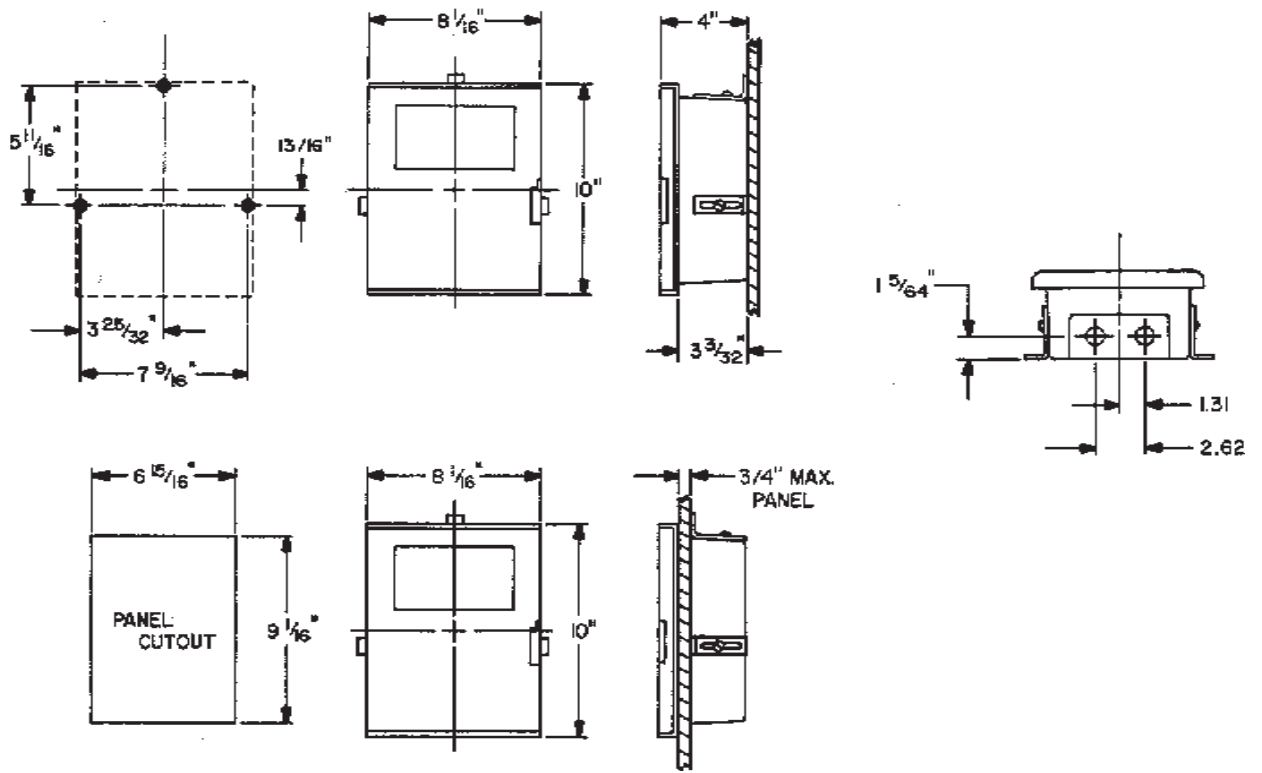
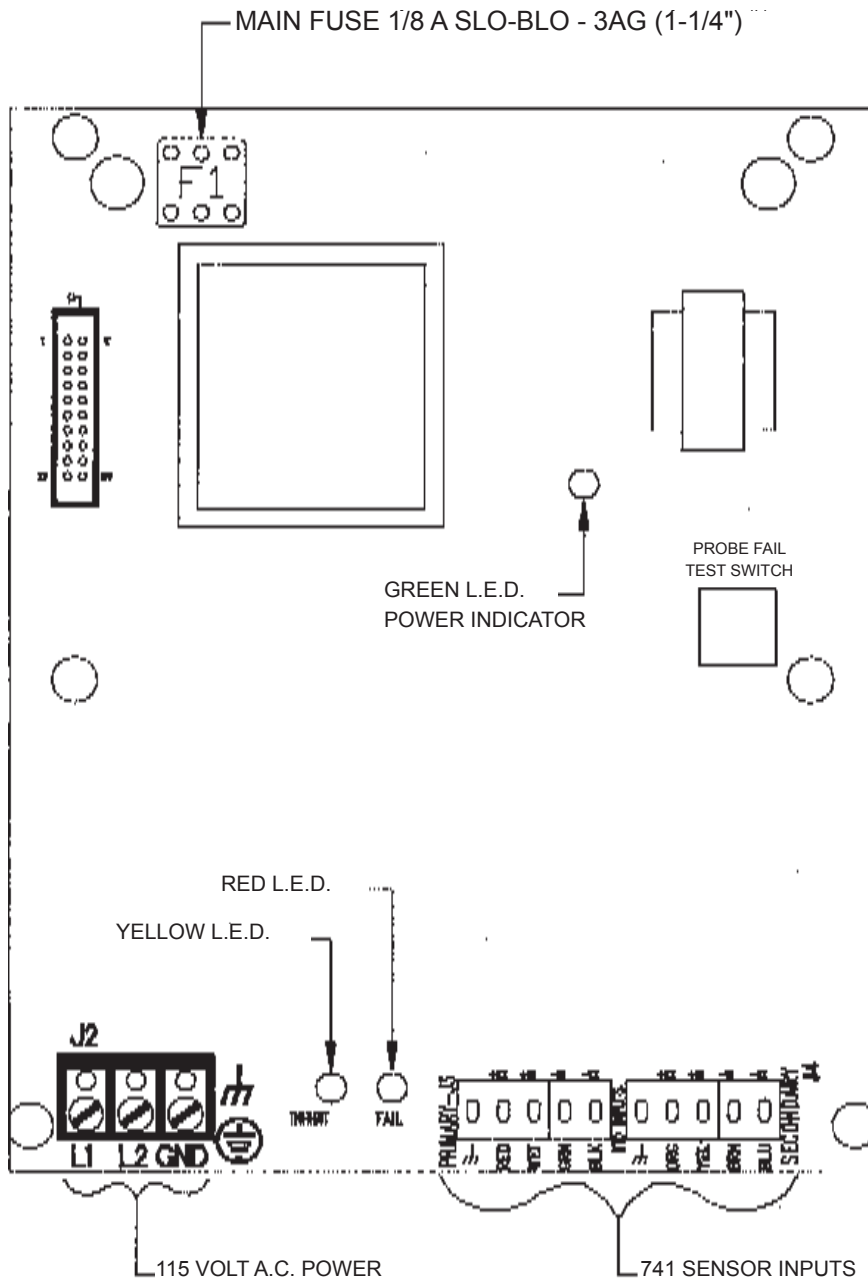

FIGURE 2



## 2.3 QDR – QUICK DISCONNECT RECEPTACLE WIRING

When used for applications not required to meet Pasteurized Milk Ordinance standards, the DART may be supplied with a QDR (Quick Disconnect Receptacle). Retort cookers and other non PMO processes are examples of where this configuration may be used. Wiring this way allows the cable to remain in place, but disconnected from the sensor and display enclosure. This is useful for systems with long cable lengths where it is desirable to perform a calibration of the DART display and sensor at another more convenient location.

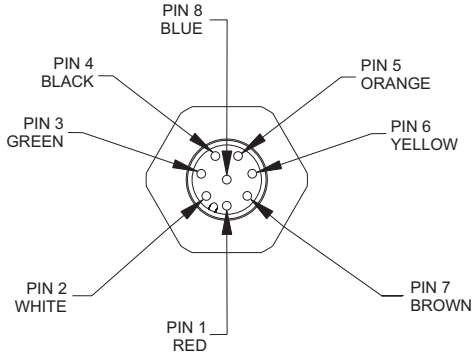
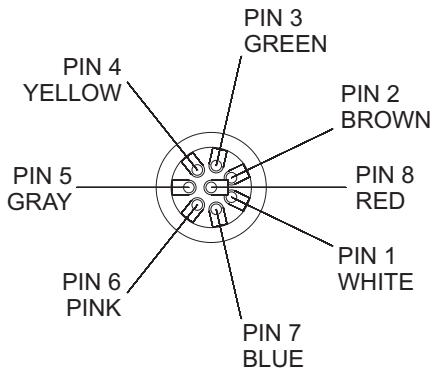
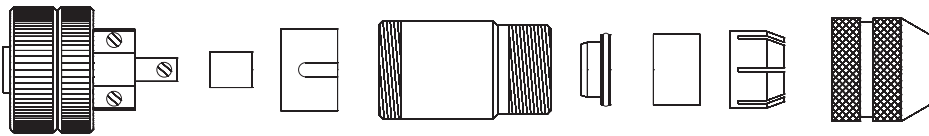

Figure represents QDR found on DART display enclosure as well as DART dual element sensor.

Color codes correspond to display enclosure inputs found on Figure 2 of this manual, as well as sensor terminals found on Figure 4 of this manual.



Wire color codes apply when molded cord supplied by Anderson, and terminated using Field Wireable Connector as shown .

Be sure to verify proper pin connections and color codes if using Customer supplied cabling.



## Section 3 - Testing Procedures

### 3.1 ACCURACY

Accuracy tests may be performed using documented procedures for existing MIG thermometers. Several important guidelines will insure the most repeatable results.

**Note:** A "stress" test, although not applicable, may be performed by exposing the probe to ice water and then boiling water.

#### GUIDELINES FOR ACCURACY TESTS

1. Use a well agitated and maintained temperature bath at or near the normal operating temperature for the system.
2. Verify the bath temperature using a certified "lab" thermometer. If the "lab" is a full-immersion type, be certain to immerse it fully.
3. Locate the calibration bath at a point from which the DRT display is readable. If this is not possible, a second person will be required to check the DRT against the "lab".
4. Allow at least five minutes for the bath and both thermometers to stabilize. The large stainless steel probe will tend to cause slight cooling of the bath upon immersion.
5. Document the DRT display temperature once it has stabilized. At this point the display should be varying by  $\pm .1^{\circ}\text{F}$  ( $\pm .06^{\circ}\text{C}$ ) or less.
6. If the DRT display is reading in agreement with the "lab", or lightly less (within  $.2^{\circ}\text{F}$ ), the DRT is well within calibration specification. The only unsealed adjustment potentiometer (or "pot") on the display board (labeled "O" in Figure 3), may be used for small zero adjustments of the display. Errors of greater than  $.5^{\circ}\text{F}$  ( $.5^{\circ}\text{C}$ ) require:
  1. Installation of a new probe or
  2. Factory Calibration

FIGURE 3

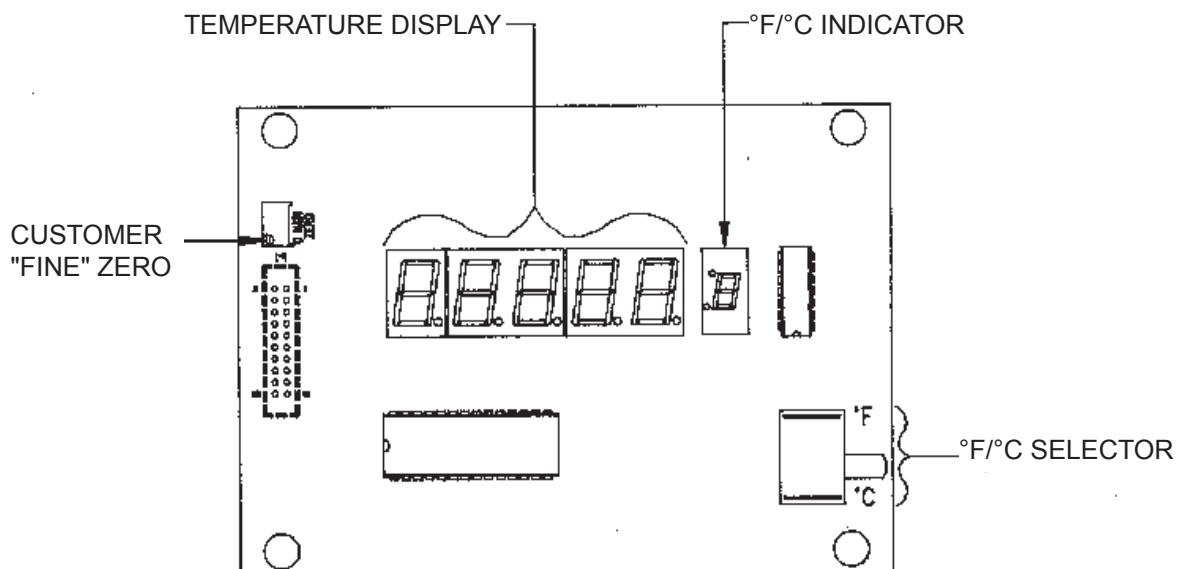

## 3.2 SPEED OF RESPONSE TEST

As with the accuracy test, documented procedures apply. Again, a few critical guidelines will insure satisfactory results:

1. Reading the display accurately for start/stop of the stopwatch can be troublesome with the tenths (in °F) or hundredths (in °C) showing. Place a small piece of non-transparent tape (masking or electrical will work) over the digits to the right of the decimal point before performing this test.
2. The degree of agitation in the bath will greatly affect response time results as with the MIG thermometer. Approximating the flow-rate of product in a typical holding tube requires a high degree of agitation. The DRT is designed to meet the response criteria even with relatively slow agitation. If unsatisfactory results are achieved, test the response again, stirring the bath with the probe itself. Document the response time and contact the factory with the results.
3. Due to the rapid digital response, the calculated temperature for starting the watch may actually be "skipped" upon immersion of the probe. In this case, retest using a starting temperature 1°F (.6°C) below the original. This will allow starting the watch at a displayed temperature rather than a "phantom". Expect a slightly longer response time since the test will be for a 13°F (7.2°C) change rather than a 12°F (6.6°C) change. The response should still be within the four second limit. If not, contact the factory.

## 3.3 ADDITIONAL TESTS

1. The diagnostic comparator circuit is provided with an inhibit/fail test button, see Figure 2, page 6. At any stable temperature (ice water works well for this), this button can be pushed and held. Within fourteen to twenty seconds, the display will blank. Pushing the button simulates a sensor imbalance combined with a very fast temperature change. If the display blanks at a time longer than twenty seconds, or does not blank, contact the factory.
2. Sensor Check: With the DRT operating at a stable temperature (ice water again will work well), note the displayed temperature. Locate the two sensor input plugs in the lower right of the instrument, see Figure 2, page 6. Remove and reinstall both plugs in the opposite position (yellow wire will now be in the furthest right position). Display should read within .1°F (0.5°C) of the temperature noted above. If not, contact factory.

FIGURE 4

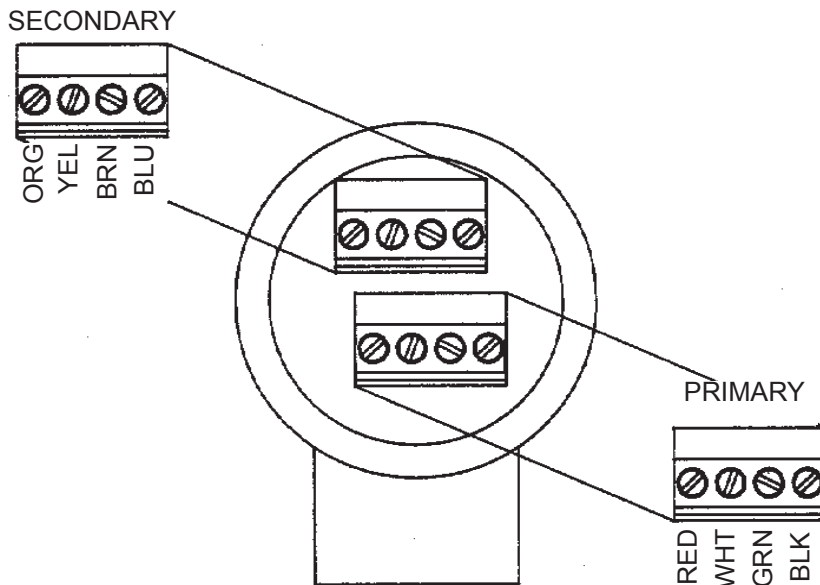

Repeatability	$\pm 0.1^{\circ}\text{F}$ ( $\pm .01^{\circ}\text{C}$ ) at ambient temperature
Ambient Temperature Range	40°F to 120°F (5°C to 49°C)
Effect of Ambient Temperature Change	.018°F for 10°F (.01°C for 5.55°C) typical
Effect of Line Voltage Change	None (from 85-138 VAC)
Long-Term Stability (Electronics only)	Within ambient temperature range of 50°F to 90°F (10°C to 32°C) less than 0.5°F (0.28°C)
Power Consumption	5 watts maximum
Power Loss Reserve Time	.1 second or six cycles minimum. (Condition: voltage prior to loss at least nominal 115V) <b>Note: Display will "blank" before reading loses accuracy.</b>
Warm-Up Time	1 hour to meet stated specifications.
Initial Accuracy Upon Power Up	$\pm .1^{\circ}\text{F}$ ( $\pm .06^{\circ}\text{C}$ )
Integrity	Display is readable ("On") only when the two measured temperatures are within .5°F (.28°C). Error limit includes both sensor and display electronics. <b>Note: A calibration check module may be purchased optionally to verify calibration precision.</b>
Display Blanking Delay (Inhibit)	For operator convenience, the .5°F agreement error limit is automatically waived during large, rapid temperature swings. Maximum inhibit time is approximately 15 seconds.
Faulty Probe Wiring	Immediately detected by "watchdog" circuit causing "blank" display (no inhibit).

## DISPLAY UNIT AND SENSOR

Calibrated Accuracy	$\pm 0.3^{\circ}\text{F}$ (0.16°C) including drift, linearity and repeatability
Stability	Stable within above limits for at least 3 months
Calibration Adjustment	"Fine" zero ( $\pm .28^{\circ}\text{F}$ to 0.5°F) only; tracks for °F and °C, easily accessible. All factory adjustments are sealed.
Speed of Response	Within four seconds for standard PMO test Pasteurized Milk Ordinance, Appendix I, Test 7
Interchangeability of Cable	Changing, adding, or subtracting cable length has no effect on system specifications
Fuse Rating	1//8 AMP SLO-BLO (3 AG 1 1/4")

## Section 4 - Troubleshooting

### 4.1 TROUBLESHOOTING AND REPAIR

The DRT is designed for ease for use and long-term repeatability. No actual repairs may be performed in the field. It is highly recommended that a spare probe be purchased with the instrument. Each probe is individually calibrated to an exact standard so replacement requires no field calibration. The spare probe works as a troubleshooting aid as well. Troubleshooting is outlined below.

Problem	Probable Cause	Solution
Display not in agreement with STLR	1. System not at stable temperature.	1. Wait for stability of system before checking.
	2. STLR not in calibration.	2. Wait for stability, then adjust pen to agree with DRT. Test both in bath at next opportunity.
DRT is found to be inaccurate during testing against reference thermometer	1. Insufficient time in bath for DRT and reference to stabilize.	1. Wait for stabilization before checking.
	2. DRT out of calibration	2. Adjust per section 3.1 or contact factory.
Display is blank	1. System is in temperature flux.	1. Wait for system temperature to stabilize.
	2. Sensor probe imbalance.	2. Replace sensor probe, test calibration and response.
	3. Problem with diagnostic circuit.	3. Contact factory.
	4. Probe beginning to fail or drift.	4. Press "test" button. See explanation below.
	5. Wiring not correct. Broken or shorted wire.	5. Check wiring (16 connections). Check connectors in probe and display.

### 4.2 TEST BUTTON PROCEDURE

If display is blank, depress test button. If probe wires are not shorted or broken, display will come on for a few seconds. If it does not, probe should be replaced. If problem still occurs, interconnecting cable is faulty and needs replacement. If display comes on for a few seconds, note the displayed temperature. Swap the two sensor input plugs. Push the test button again and note the displayed temperature. If the two noted displays differ by more than 1/2 degree F, then the sensor is beginning to fail or drift and requires replacement.

Also, if a calibration test fixture is purchased with the instrument, plug this into the unit to verify its operation. If display unit works with the fixture, check probe and wiring.

**Note: If display is blank but the decimal point and/or degree F-degree C indicator is on, 115 VAC power is ok. If not, unit has no power.**

## Appendix A - Specifications

### SENSOR

Type	Dual element (8-wire), Resistive
Material	316 Stainless steel
Finish	Meets or exceeds 3-A sanitary standards (#09-08)
Process Connections	Split ferrule or sanitary clamp type in a variety of sizes
Wiring Connection	Integral conduit housing with cap sealable by health authority
Cable Length	25 feet standard; 1500 feet maximum
Stability	Within .40°F (.22°C) per year
Initial Accuracy	Hand calibrated within .072 °F (.04°C) at 32°F (0°C) and 212°F (100°C)
Linearity	± .036°F (0.02°C) from 0°C to 100°C
Interchangeability	± 0.1°F (± 0.06°C)

### DIGITAL DISPLAY

Type	Remote mount, wall or panel
Material	Die-cast aluminum with two-part polyurethane paint
Closure	Fully gasketed with provision for health authority seal
Dimensions	See Section 2
Display	1/2" LED, 4 1/2 active digits
Power	115 VAC nominal; 50/60 Hz 85 VAC minimum 138 VAC maximum
Display Value	Fahrenheit or Celsius (user selectable)
Display Range	-148°F to 392°F (-100°C to 199.99°C)
Resolution	0.1°F (0.01°C)
Initial Accuracy	At ambient temperature (70-80°F) from -58 to 302°F (-50°C to 150°C): ± .02°F (± .01°C)
Linearity	± 0.1°F (0.06°C)

## ***Warranty and Return Statement***

These products are sold by The Anderson Instrument Company (Anderson) under the warranties set forth in the following paragraphs. Such warranties are extended only with respect to a purchase of these products, as new merchandise, directly from Anderson or from an Anderson distributor, representative or reseller, and are extended only to the first buyer thereof who purchases them other than for the purpose of resale.

### ***Warranty***

These products are warranted to be free from functional defects in materials and workmanship at the time the products leave the Anderson factory and to conform at that time to the specifications set forth in the relevant Anderson instruction manual or manuals, sheet or sheets, for such products for a period of three years for the digital display and one year for the sensor.

**THERE ARE NO EXPRESSED OR IMPLIED WARRANTIES WHICH EXTEND BEYOND THE WARRANTIES HEREIN AND ABOVE SET FORTH. ANDERSON MAKES NO WARRANTY OF MERCHANTABILITY OR FITNESS FOR A PARTICULAR PURPOSE WITH RESPECT TO THE PRODUCTS.**

### ***Limitations***

Anderson shall not be liable for any incidental damages, consequential damages, special damages, or any other damages, costs or expenses excepting only the cost or expense of repair or replacement as described above.

Products must be installed and maintained in accordance with Anderson instructions. Users are responsible for the suitability of the products to their application. There is no warranty against damage resulting from corrosion, misapplication, improper specifications or other operating condition beyond our control. Claims against carriers for damage in transit must be filed by the buyer.

This warranty is void if the purchaser uses non-factory approved replacement parts and supplies or if the purchaser attempts to repair the product themselves or through a third party without Anderson authorization.

### ***Returns***

Anderson's sole and exclusive obligation and buyer's sole and exclusive remedy under the above warranty is limited to repairing or replacing (at Anderson's option), free of charge, the products which are reported in writing to Anderson at its main office indicated below.

Anderson is to be advised of return requests during normal business hours and such returns are to include a statement of the observed deficiency. The buyer shall pre-pay shipping charges for products returned and Anderson or its representative shall pay for the return of the products to the buyer.

Approved returns should be sent to:      ANDERSON INSTRUMENT COMPANY INC.  
156 AURIESVILLE ROAD  
FULTONVILLE, NY 12072 USA

ATT: REPAIR DEPARTMENT