

Product Information NSL-F-00, NSL-F-01, NSL-F-02

FOOD

Continuous level sensor NSL-F-00, -01, -02

Application/intended use

- Continuous level monitoring in metallic vessels up to 10 ft (3 m) in height
- Ideally suited for highly adhesive and pasty media
- Level measurement of foaming media
- Minimum product conductivity typically from 50 $\mu\text{S}/\text{cm}$ (available on request for lower values)
- Hygienic substitute for float sensors

Application examples

- Level monitoring in feed vessels
- Level measurement in storage tanks
- Content measurement in pressurized vessels

Hygienic design/process connection

- Fixed fittings conform to 3-A 74-06 Sanitary Standard
- Product contacting materials compliant to FDA
- Option to use Negele CLEANadapt EHEDG compliant hygienic installation accommodates a broad range of process connection adapters
- Sensor made of stainless steel (protection class NEMA 4X and IP 69 K)
- CIP and SIP cleaning up to 290 °F (143 °C) for a maximum of 120 minutes

Special features/advantages

- 4-wire sensor with 4...20 mA output signal
- Due to potentiometric measurement principle, no adjustment needed after media change
- Individual parameter adjustment and programming via PC interface
- Adjustment of the M12 plug by means of the twistable sensor head
- Mounting in vessels from the below or above
- Mounting on the side with angled sensor
- Adjustable current signal for measurement range, dry run signal and error signal

Options/accessories

- Simple User Interface with display
- PVC Molded M12 shielded cord-set
- Programming adapter MPI-200 with PC software

Functional principle

The potentiometric measuring principle measures the change in the voltage ratio between the electrode rod of the sensor and the metallic wall of the filled tank. An electric flow field arises in the medium due to the electrical conductivity of the medium and its capacitive properties. This gives rise to a voltage ratio that is proportional to the immersed part of the rod.

Because only the ratio of the voltages is considered, the properties of the medium, in particular the electrical conductivity, do not enter into the measurement result. Using a second, patent-pending measuring procedure, the sensor also provides information on the submersion state of the electrode rod. This system analyzes electrical resonance properties to detect foam and suppress it partly in the results, and to reliably prevent erroneous measurements due to adhesions.

Authorizations



Government-funded

Supported by:



on the basis of a decision by the German Bundestag

Continuous level sensor NSL-F-00



Functional principle

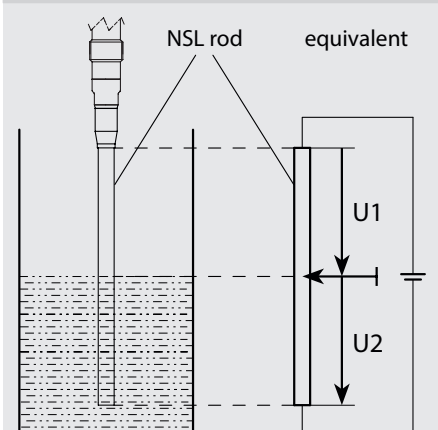

Specification		
Rod length EL	Product contacting	3000 mm max. (NSL-F-00) 1500 mm max. (NSL-F-01)
Measurement range MB	NSL-F-00 NSL-F-00 NSL-F-01	50...199 mm (rod diameter 6 mm) 200...3000 mm (rod diameter 10 mm) L2 see drawing on page 6 (rod diameter 10 mm)
Process connection	Thread Tri-Clamp Varivent	CLEANadapt G1/2", G1" hygienisch 1...1½", 2", 2½", 3", 4" DN 10/15 (type B), DN 25 (type F), DN 40/50 (type N)
Process pressure		230 psi (16 bar) max.
Tightening torque		10 Nm
Materials	Connecting head Plastic cap/viewing window Threaded connector Insulating part Rod	stainless steel 1.4308 (CF-8) Polycarbonate stainless steel 1.4305 (303) PEEK (FDA approval number: 21 CFR 177 2415) stainless steel 1.4404, R _a ≤ 0.8 µm
Temperature range	Ambient Storage temperature Process CIP/SIP cleaning	32...158 °F (0...70 °C) -40...185 °F (-40...85 °C) 14...284 °F (-10...140 °C) 290 °F (143 °C) max 120 minutes
Resolution	Rod length > 500 mm Rod length < 500 mm	< 0.1 % of upper range value (= rod length) < 0.5 mm
Accuracy	Media with conductivity > 50 µS/cm (e.g. beer, milk, beverages) Media with conductivity < 50 µS/cm	< 1 % of rod length On request since dependent on installation situation and tank design
Linearity		< 1.0 % of the upper range value (= rod length)
Reproducibility	Rod length > 500 mm Rod length < 500 mm	< 0.2 % of upper range value (= rod length) < 1.0 mm
Temperatur drift	At 25 °C	≤ 0.1 %
Response time		< 100 ms
Electrical connection	Supply Protection class Output signal Ohmic resistance	18...36 V DC NEMA 4X and IEC IP 69 K Analog 4...20 mA, galvanically separated from housing, 2-wire loop 0...750 Ω
Weight		920 g with rod length of 1.5 m

Conventional usage

- Not suitable for applications in explosive areas.
- Not suitable for applications in security-relevant equipment (SIL).



NSL-F ... with horizontal head

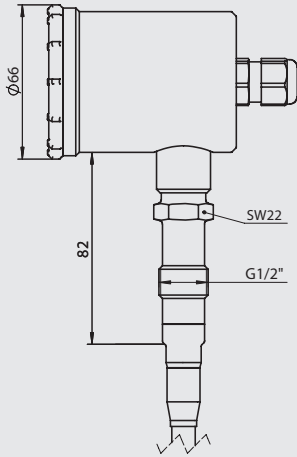

Rod diameter



Rod diameter is depending on rod length (EL). For exact diameter see below-mentioned tables.

Rod diameter NSL-F-00

EL	Ø D
50...199 mm	6 mm
200...3000 mm	10 mm

Rod diameter NSL-F-01

EL	Ø D
80...1500 mm	10 mm

Tri-Clamp diameter

Type	Ø A
TC1	50.5 mm
TC2	64 mm
T25	77.4 mm
TC3	91 mm
TC4	118.9 mm

NSL-F-00/.../S00/... with EL > 200 mm

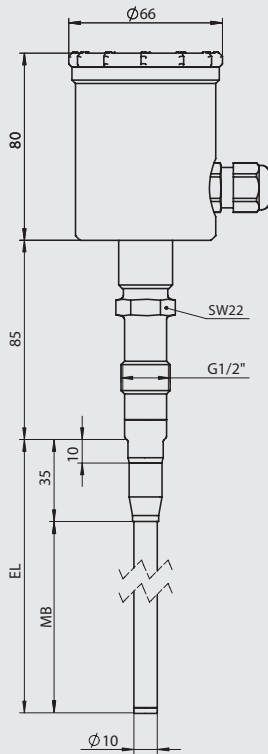

NSL-F-00/.../S01/... with EL > 200 mm

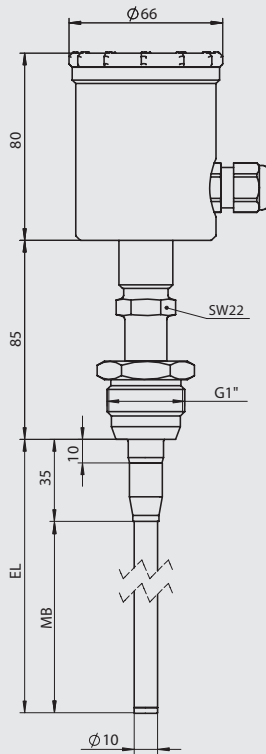

NSL-F-00/.../TC1/... with EL > 200 mm

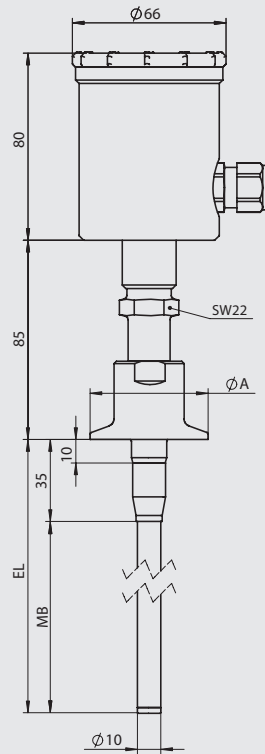

NSL-F-00/.../S00/... with EL < 200 mm

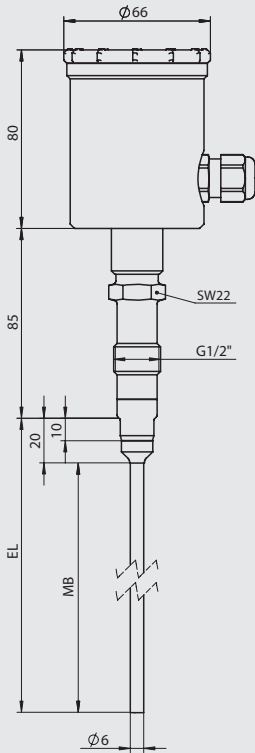

NSL-F-00/.../S01/... with EL < 200 mm

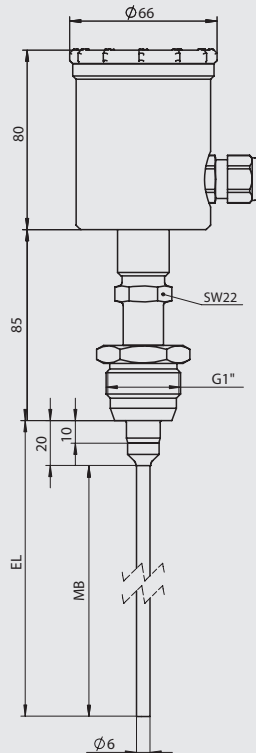

NSL-F-00/.../TC1/... with EL < 200 mm

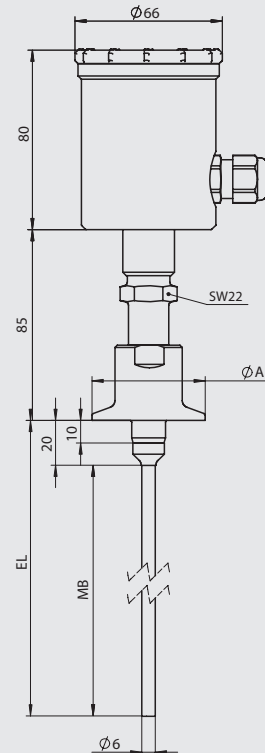

Mounting position



If the sensor is mounted into a vessel from below, there is a range of 20 mm or 35 mm from the sealing edge (see dimensional drawing) where the level cannot be reliably measured. The 4 mA/20 mA signal starts with the bottom weld seam of the rod.

Conditions for a measuring point according to 3-A Sanitary Standard 74-06



- The sensors NSL-F conforming to the 3-A Sanitary Standard.
- The sensors are designed for CIP-/ SIP-cleaning. Maximum 290 °F (143 °C) for 120 minutes.
- Only permitted with the **CLEANadapt** build-in system (EMZ, EMK, adapter AMC and AMV).
- When using the EMZ and EMK weld-in sleeves, the weld must comply with the requirements of the current 3-A Sanitary Standard.
- Mounting position: The mounting position, self-draining properties and the position of the leakage hole must be in accordance with the current 3-A Sanitary Standard.

Electrical connection with M12 plug

1: red	+ power supply	
2: black	- power supply	
3: green	- output	
5: white	+ output	

Electrical connection with cable gland

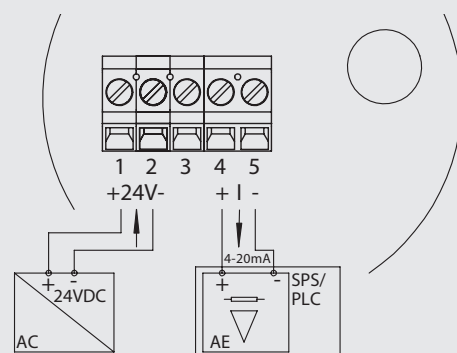

Adjustment of parameters that have already been set

Using the self-explanatory PC-based software and the MPI-200 programming adapter, the following NSL-F parameters can easily be adjusted on-site (at the vessel with filling medium) or alternatively in the office with a dry simulation. For example:

4...20 mA signal

- Level height for (4/20) mA signal
- "Dry run" warning signal
- "Failure" error signal
- Signal limit for underrange and overrange
- "Underflow/overflow" error signal
- Signal simulation (3.95...20.05 mA)

Level measurement

- Level zero/offset
- level slope/gain
- Damping/filter
- Physical unit

Mounting position

The default setting of the NSL-F level sensor is intended for operation with aqueous media without requiring adjustments. In exceptional cases involving highly critical media or special tank contours (with internal structures such as a pipe), it may be necessary to make adjustments to some of the parameters. The parameterization can be adjusted using the PC-based MPI-200 or the Simple User Interface.

Possible parameter/settings	
4...20 mA current signal	
Underrange	2.40; 3.20; 3.40; 3.60; 3.80; 3.95; 4.00 mA
Overrange	20.00; 20.05; 20.50; 21.00; 21.40; 21.60; 21.80; 22.00 mA
Warning and error signal (e.g. dry run)	2.40; 3.20; 3.40; 3.60; 3.95; 4.00; 20.00; 20.05; 20.50; 21.00; 21.20; 21.40; 21.60; 21.80; 22.00 mA
Level measurement	
Zero/slope	-50...50 % / 50...150 %
Damping	0; 0.1; 0.2; 0.5; 1; 2; 5 s

Transport/storage

- Do not store outside
- Store in an area that is dry and dust-free
- Do not expose to corrosive media
- Protect against solar radiation
- Avoid mechanical shock and vibration
- Storage temperature -40...185 °F (-40...+85 °C)
- Relative humidity maximum 98%

Reshipment

- Sensors and process connection shall be clean and must not be contaminated with dangerous media and/or heat-conductive paste! Note the advice for cleaning!
- To avoid damage of the equipment, use suitable transport packaging only.

Cleaning/maintenance

- In case of using pressure washers, don't point nozzle directly to electrical connections!

Standards and guidelines

- Compliance with the applicable regulations and directives is mandatory.

Advice to EMC

- Applicable guidelines:
- Electromagnetic compatibility 2004/108/EC
 - The CE label confirms compliance of this product with the applicable EC directives.
 - You have to guarantee the compliance of all guidelines applicable for the entire equipment.

Disposal

- This instrument is not subject to the WEEE directive 2002/96/EC and the respective national laws.
- Give the instrument directly to a specialized recycling company and do not use the municipal collecting points.

Accessories

Standard Molded Cord Set

42117K0025	25'
42117K0050	50'
42117K0100	100'

Heavy Duty Molded Cord Set

42117F0025	25'
42117F0050	50'
42117F0100	100'

Programming adapter/PC interface

MPI-200 Including PC software

PVC cable with M12 connection

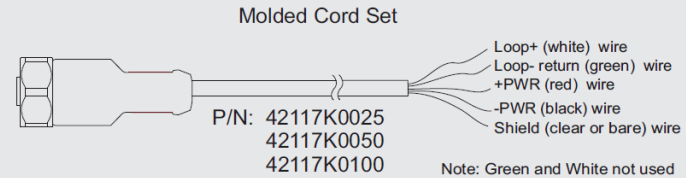
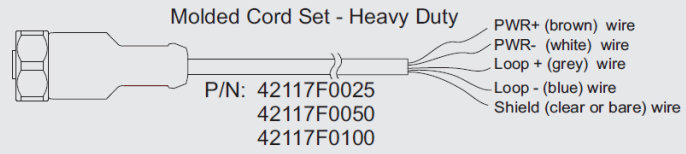

Note: Green and White not used on 2 wire devices.
Shield not connected to nut.

Version NSL-F-01

The NSL-F sensor is optionally available as version NSL-F-01 with a curved rod.

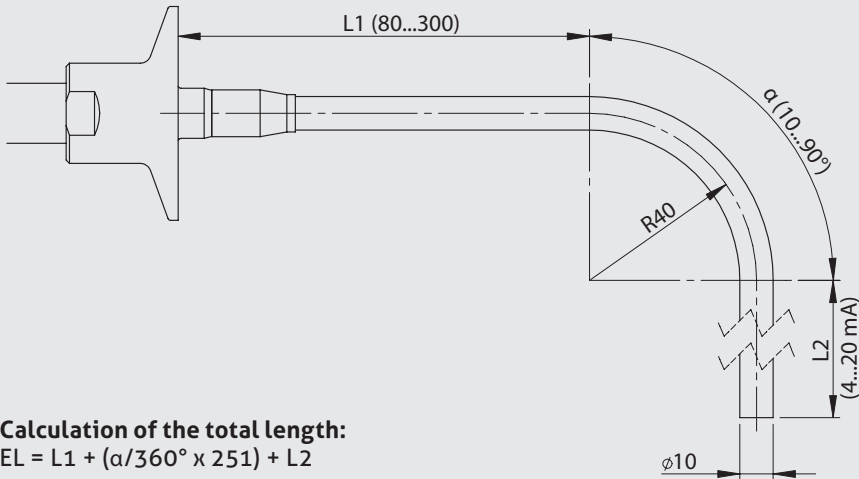

Drawing option PK

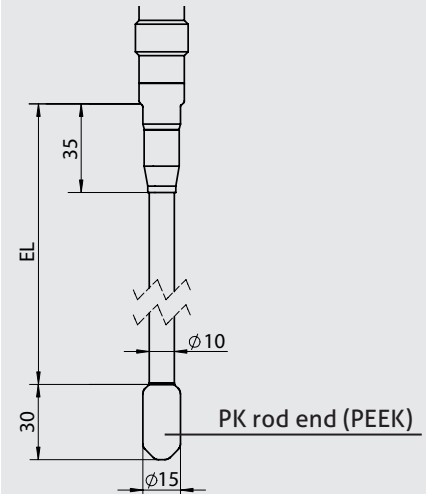

Insulation at rod end (option PK)



Order code

NSL-F-01 (Potentiometric level sensor for food application, 4-wire technology, angled version)

Rod length EL, please order in 10-mm steps, e.g.: 0220, 0230, 0240, etc., max length 1500 mm.
(intermediate sizes in 1-mm steps available on request)

0090...

1500 (Material 1.4404)

Process connection

S00 (CLEANadapt G1/2" hygienic)
S01 (CLEANadapt G1" hygienic)
TC1 (Tri-Clamp 1½")
TC2 (Tri-Clamp 2")
T25 (Tri-Clamp 2½")
TC3 (Tri-Clamp 3")
TC4 (Tri-Clamp 4")

Material certificate

O (No certificate, standard)
Z (With 3.1 material certificate for 1.4404)

Installation position

1 (Installation from top, head orientation horizontal)
2 (Installation from top, head orientation vertical)
3 (Installation from bottom, head orientation horizontal)
4 (Installation from bottom, head orientation vertical)
5 (Installation from top, head orientation horizontal, with PEEK insulation on top)
6 (Installation from top, head orientation vertical, with PEEK insulation on top)

Output signal

A42 (4...20 mA, analog, 4-wire)

Electrical connection

L (M12-plug, 5-pins, wiring according to LN sensor)

Interface/Display

X (Without interface)
L (Display interface)

Cap

X (Plastic without control window)
M (Stainless steel without control window)
W (Stainless steel with control window)

Insulation at rod end

XX (Without, standard)
PK (PEEK insulation >> EL + 30 mm)

Parameter configuration

X (Standard)

**Details on angled version
(max. EL 1500 mm)**

80...300 (Length L1 in mm)
10...90 (Angle α in °)

NSL-F-01/ 1500/ S00/ O/ 1/ A42/ L/ X/ X/ XX/ X/ 150-90

Order code

NSL-F-00 (Potentiometric continuous level sensor, compact version in 4-wire technology, straight design)

Rod length EL, choose length in a 10-mm raster, e.g.: 0220, 0230, 0240 etc., max. length 3000 mm.
(intermediate sizes in 1-mm steps on request.)

0050...3000 (material 1.4404)

Process connection

- S00** (CLEANadapt G1/2" hygienic)
- S01** (CLEANadapt G1" hygienic)
- TC1** (Tri-Clamp 1½")
- TC2** (Tri-Clamp 2")
- T25** (Tri-Clamp 2½")
- TC3** (Tri-Clamp 3")
- TC4** (Tri-Clamp 4")

Material certificate

- O** (No certificate, standard)
- Z** (With 3.1 material certificate for 1.4404)

Installation position

- 1** (Installation from top, head orientation horizontal)
- 2** (Installation from top, head orientation vertical)
- 3** (Installation from bottom, head orientation horizontal)
- 4** (Installation from bottom, head orientation vertical)
- 5** (Installation from top, head orientation horizontal, with PEEK insulation on top)
- 6** (Installation from top, head orientation vertical, with PEEK insulation on top)

Output signal

A42 (4...20 mA, analog, 4-wire)

Electrical connection

L (M12-plug, 5-pins, wiring according to LN sensor)

Interface/Display

- X** (Without interface)
- L** (Display interface)

Cap

- X** (Plastic cap without control window)
- M** (Stainless steel without control window)
- W** (Stainless steel with control window)

Insulation at rod end

- XX** (Without, standard)
- PK** (With PEEK insulation >> EL + 30 mm)

Parameter configuration

- X** (Standard)

NSL-F-00/ 1500/ S00/ O/ 1/ A42/ L/ X/ X/ XX/ X

Continuous level sensor NSL-F-02 double rod version

Range of application

- Continuous level measurement in non-metallic vessels
- Level measurement of foaming media
- Minimum product conductivity typically from 50 $\mu\text{S}/\text{cm}$ (available on request for lower values)
- Hygienic substitute for float sensors

Application examples

- Process such as ballance tanks and fillers
- Level measurement in storage vessels
- Level monitoring in pressurized vessels

Hygienic design/Process connection

- The Tri-Clamp and Varivent hygienic process connections and an adapter solution using the Negele CLEANadapt installation system ensure an easy-to-sterilize hygienic installation configuration without gaps and dead spaces.
- Product contacting materials compliant to FDA
- Sensor made of stainless steel (protection class IP 69 K)
- CIP-/SIP-cleaning up to 290 °F (143 °C) / max. 120 minutes

Features

- Individual parameter adjustment or programming via PC interface
- Current signal for measurement range, dry signal and error signal adjustable

Authorizations



Government-funded

Supported by:



on the basis of a decision
by the German Bundestag

Note



This product information is a supplement to Product Information NSL-F-00.

Except for the rod length of 200 mm up to max. 1500 mm, the NSL-F-02 is identical to the NSL-F-00. The data, instructions and other information provided in Product Information NSL-F-00 also apply to this sensor variant.

Drawing NSL-F-02

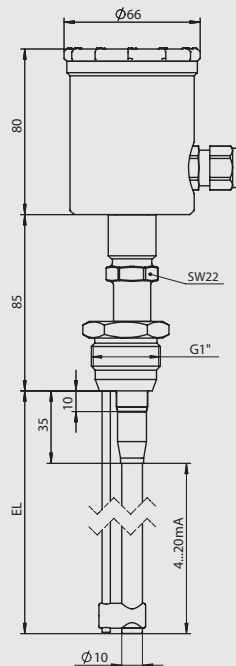

NSL-F-02



Order code

NSL-F-02 (Potentiometric level sensor for food application, compact version in 4-wire technology, double rod version)

Rod length EL, please order in 10-mm steps, e.g.: 0220, 0230, 0240, etc., max length 1500 mm.
(intermediate sizes in 1-mm steps available on request)

0200...1500 (material 1.4404)

Process connection version

S21 (CLEANadapt G1" hygienic, for double rod version, sensor excentric)
TC1 (Tri-Clamp 1½")
TC2 (Tri-Clamp 2")
T25 (Tri-Clamp 2½")
TC3 (Tri-Clamp 3")
TC4 (Tri-Clamp 4")

Material certificate

O (No certificate, standard)
Z (With 3.1 material certificate for 1.4404)

Installation position

1 (Installation from top, head orientation horizontal)
2 (Installation from top, head orientation vertical)
3 (Installation from bottom, head orientation horizontal)
4 (Installation from bottom, head orientation vertical)
5 (Installation from top, head orientation horizontal, with PEEK insulation on top)
6 (Installation from top, head orientation vertical, with PEEK insulation on top)

Output signal

A42 (4...20 mA, analog, 4-wire)

Electrical connection

L (M12 plug 5-pins, pin assignment according to LN sensor)

Interface/Display

X (Without interface)
L (Display interface)

Cap

X (Plastic cap without sight glass)
M (Stainless steel cap without sight glass)
W (Stainless steel with control window)

Insulation at rod end

XX (Without, standard)

Parameter configuration

X (Standard)
C (Write out details)

NSL-F-02 / 0500 / S21 / O / 1 / A42 / P / X / X / XX / X