



# READ THIS FIRST

## Installation and Startup Guide

# “ILM” Conductivity Sensor

Version 1.1 Document 1191



ANDERSON-NEGELE

Anderson Instrument Co., Inc.  
 156 Auriesville Rd., Fultonville, NY 12072  
 Phone: 518-922-5315  
 Fax: 518-922-8997  
 www.anderson-negele.com

### PRODUCT DESCRIPTION

The Anderson-Negele ILM is an all integral non-contacting Conductivity sensor designed for hygienic applications in the food and dairy industry. Offering dual analog outputs for conductivity measurement and temperature and multiple range selections the ILM is optimized for use in the control of CIP chemical concentration and phase separation applications.

### SPECIFICATIONS

<b>Process connections</b>	thread G1" torque	sensor, combined with Negele-weld-in sleeves max. 20 Nm
<b>Materials</b>	connector head thread connection bobbin case window in lid	stainless steel 1.4305 (303), Ø 89 mm stainless steel 1.4305 (303), SW 36 mm PEEK, FDA-number (21CFR177.2415) PMMA
<b>Temperature Ranges</b>	ambient process CIP/SIP cleaning	-10...+60 °C 0...100 °C up to 140 °C/30 minutes max.
<b>Pressure</b>		10 bar max.
<b>Protection Class</b>		IP 69 K (with PG cable gland and suitable cable)
<b>Reproducibility</b>	of conductivity	≤ 1 % of measurement value
<b>Resolution</b>	measurement range < 10 mS/cm 10...50 mS/cm 100...999 mS/cm	1 µS/cm 10 µS/cm 100 µS/cm
<b>Accuracy</b>	span offset	±2 % of upper range value ±20 µS/cm
<b>Long Term Stability</b>	span offset	±0.5 % of upper range value ±20 µS/cm
<b>Accuracy of the Temperature Output</b>	≤ 100 °C 100...150 °C	0.5 °C max. 1.0 °C max.
<b>Electrical Connection</b>	cable gland cable connection supply	2 x M16 x 1.5 2 x M12 plug 1.4305 18...36 V DC max. 190 mA
<b>Inputs</b>	range switching	E1 and E2 (24 V DC) galvanically isolated
<b>Outputs</b>	conductivity temperature	analog 4...20 mA short-circuit-proof analog 4...20 mA short-circuit-proof
<b>LC-Display</b>	with backlight	2 x 8-digits
<b>Measurement Principle</b>	wearless	inductive

Comparison ILM-2 / ILM-3	ILM-2	ILM-3
Measurement Ranges Conductivity	0...2 mS/cm up to 0...999 mS/cm 12 measurement ranges selectable 3 ranges extern switchable	0...0.5 mS/cm up to 0...999 mS/cm 14 measurement ranges selectable 4 ranges extern switchable
Measurement Ranges Temperature	0...+150 °C 1 measurement range fix presetted	-20...+150 °C 7 measurement ranges selectable
Temperature Coefficient (TC)	0...5 %/K, free adjustable 1 TC for all measurement ranges	0...5 %/K, free adjustable 1 TC for each measurement range

## MOUNTING

- The ILM is designed with a G1" clean-adapt connection. Always use approved Anderson-Negele adapters when using this product.
- When used properly with the AMC-351-DNXX adapter the ILM will provide a tri-clamp fitting for a process connection and a device that is compliant with 3-A standards. When attaching the AMC to the ILM it is important to align the leak detection port located on the adapter with the flow through hole of the torroidal sensor. When the sensor is used in vertical piping configurations this will locate the leak detection port at the lowest possible point allowing any liquid internal to the fitting to exit the fitting and satisfying 3-A installation requirements. It is also important to note that the connection between the adapter and the ILM needs to be torqued to 14.8 lb-ft (20 Nm). **It is important not to turn the head of the sensor in relation to the fitting after the connection has been tightened as this may damage the sensor.**
- The sensor location in the piping should be such that the sensor stays immersed in liquid during the needed measuring periods. This can be readily achieved by installing in a vertical line that flows upward.
- Avoid locations where high vibration is a concern as this may create false indication.

## WIRING

### With M12 plug

M12 plug left (4 pin)  
outputs 4...20 m

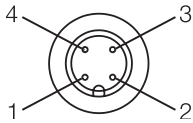

- 1: output conductivity +
- 2: output temperature +
- 3: output temperature -
- 4: output conductivity -

M12 plug right (5 pin)  
supply/control voltages

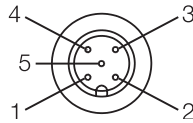

- 1: supply +24 V DC
- 2: digital input E2
- 3: 0 V (measurement range switching)
- 4: supply -
- 5: digital input E1

### With S12 option

Left (4 pin)

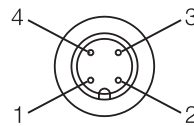

- 1: conductivity -
- 2: conductivity +
- 3: supply +24 VDC
- 4: supply -

Right (5 pin)

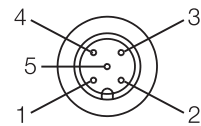

- 1: output temperature +
- 2: digital input E2
- 3: 0 V (measurement range switching)
- 4: output temperature -
- 5: digital input E1

### Changing the Measuring Range

The ILM is factory set to:

Measurement range 1: 0-20 mS/cm = 4-20 mA (see programming to change)

TC-value: 2 %/K

It is possible to externally change the selected range

With the use of an external control voltage +24 V DC (18...36 V) range 2 (E1=24 V), range 3 (E2=24 V) or range 4 (E1=E2=24 V) can be selected (see "Wiring").

The ILM-2 has only 1 TC that is effective for all measurement ranges and a fixed temperature output is that is set to 0...150 °C.

The ILM-3 has a separate temperature coefficient (TC) for each range and the measurement range of the temperature output can be selected from 7 preset ranges between -20...150 °C

### Switching the measuring range via inputs

The digital control inputs E1 and E2 are galvanically isolated from supply voltage.

E1	E2	Meas. Range
0	0	1
1	0	2
0	1	3
1	1	4*

0=0VDC, 1=24VDC, \* ILM-3 only

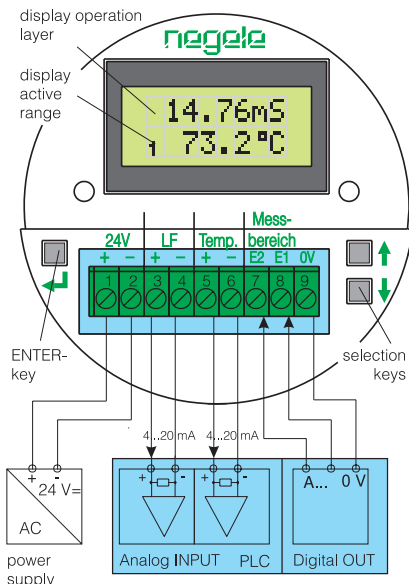

### Optimizing the temperature coefficient for a liquid

- Adjust "TC" to 0 %/K (see Programming).
- Dip sensor into liquid with 25 °C (77 °F).
- Wait until the measurement value is stable.
- Record the conductivity value from the display.
- Warm up the liquid to 60 °C (140 °F) minimum. This will Change the conductivity value on the display.
- Wait until the measurement value is stable.
- Select "TC" in the operation menu and adjust the temperature coefficient until the displayed measurement value is equal to the value noted at step 4.

# PROGRAMMING MENU

## Programming Keys

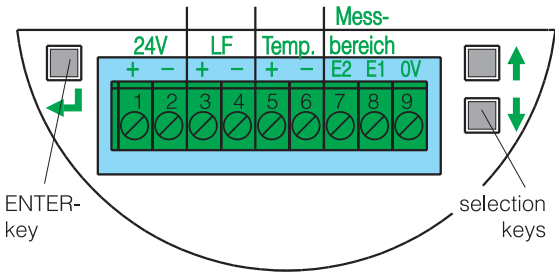

## ILM-2 Programming

**Temperature Coefficient Level TC**

**Measurement Range 3**  
(E2 = 24 V)

**Measurement Range 2**  
(E1 = 24 V)

**Measurement Range 1**  
(E1, E2 0 V)

**Display**  
Conductivity and Temperature

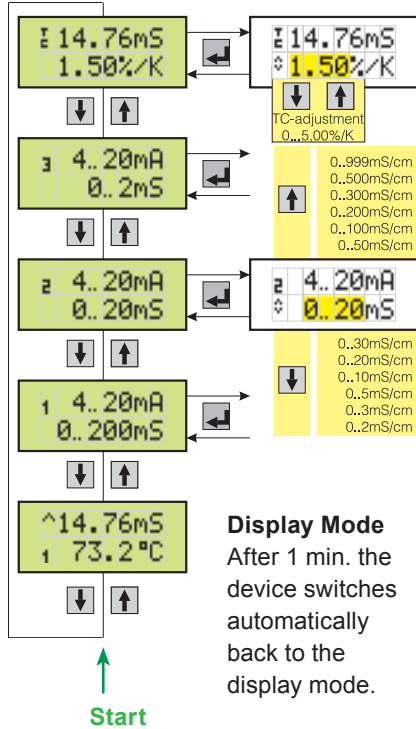

**Display Mode**  
After 1 min. the device switches automatically back to the display mode.

## Status Messages

### ^-Symbol

“Current output conductivity overload”, will be displayed if the measured value is higher than the selected measurement range.  
I<sub>out</sub>: ca. 22 mA

### 4 (upper line)

currently editable range

### 1 (lower line)

currently activated measurement range

### ^,^^^ -Symbol

the currently measured value is higher than the maximum measurement value (999 ms/cm)  
I<sub>out</sub>: ca. 22 mA

### ◇-Symbol

the adjoining value is now editable via arrow buttons

### vvv -Symbol

inductor error/sensor break  
I<sub>out</sub>: 2.4 mA

## ILM-3 Programming

**Temperature Output**

**Temperature Coefficient 4**

**Measurement Range 4**

**Temperature Coefficient 3**

**Measurement Range 3**

**Temperature Coefficient 2**

**Measurement Range 2**

**Temperature Coefficient 1**

**Measurement Range 1**

**Display**  
Conductivity and Temperature

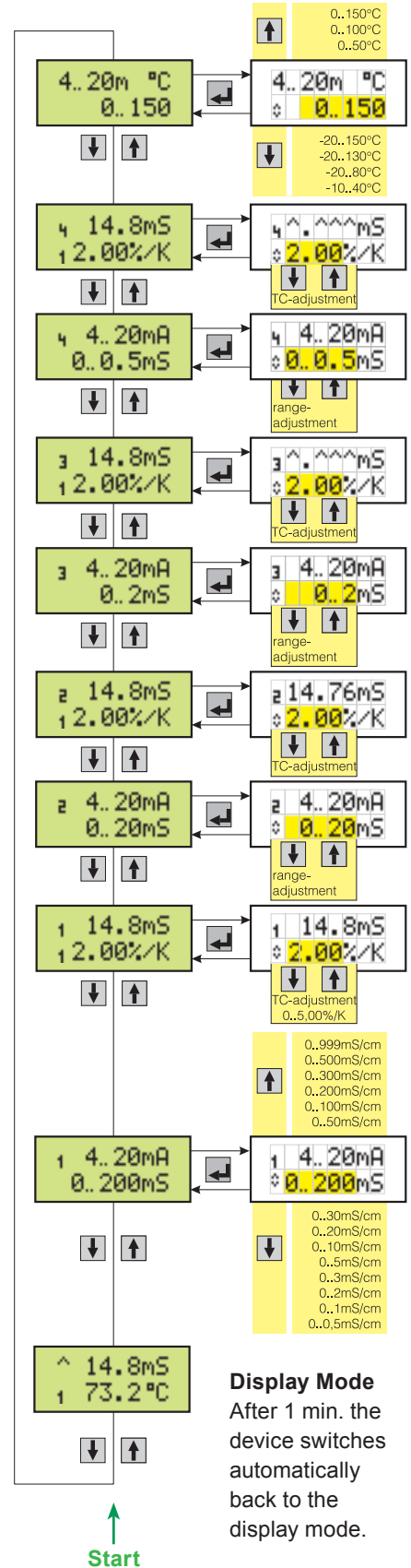

## CLEANING AND MAINTENANCE

The ILM is designed to be CIP/SIP at the temperature indicated in the specifications. Although the exterior is water-tight, high pressure washers should avoid the electrical connections.

## TRANSPORTATION/STORAGE

- Do not store outside
- Store in an area that is dry and dust free
- Do not expose to corrosive media
- Protect from direct sunlight
- Avoid shock and vibration
- Storage temperature 32-104°F (0-40°C)
- 

## RETURNING FOR REPAIR

- Sensors and adapters need to be clean and must not be contaminated with hazardous material
- Pack appropriately to avoid damage to the sensor

## DISPOSAL

- This instrument is not subject to the WEEE directive 2002/96/EG and the respective national laws
- Do not use municipal waste to dispose of this product. Use a specialized recycling center for disposal

## DIMENSIONAL DRAWING

