

# Instruction Manual



Anderson Instrument Co. Inc.  
156 Auriesville Road  
Fultonville, NY 12072  
1-800-833-0081  
Fax 518-922-8997

www.anderson-negele.com

Instrument Model Number \_\_\_\_\_

Instrument Serial Number \_\_\_\_\_

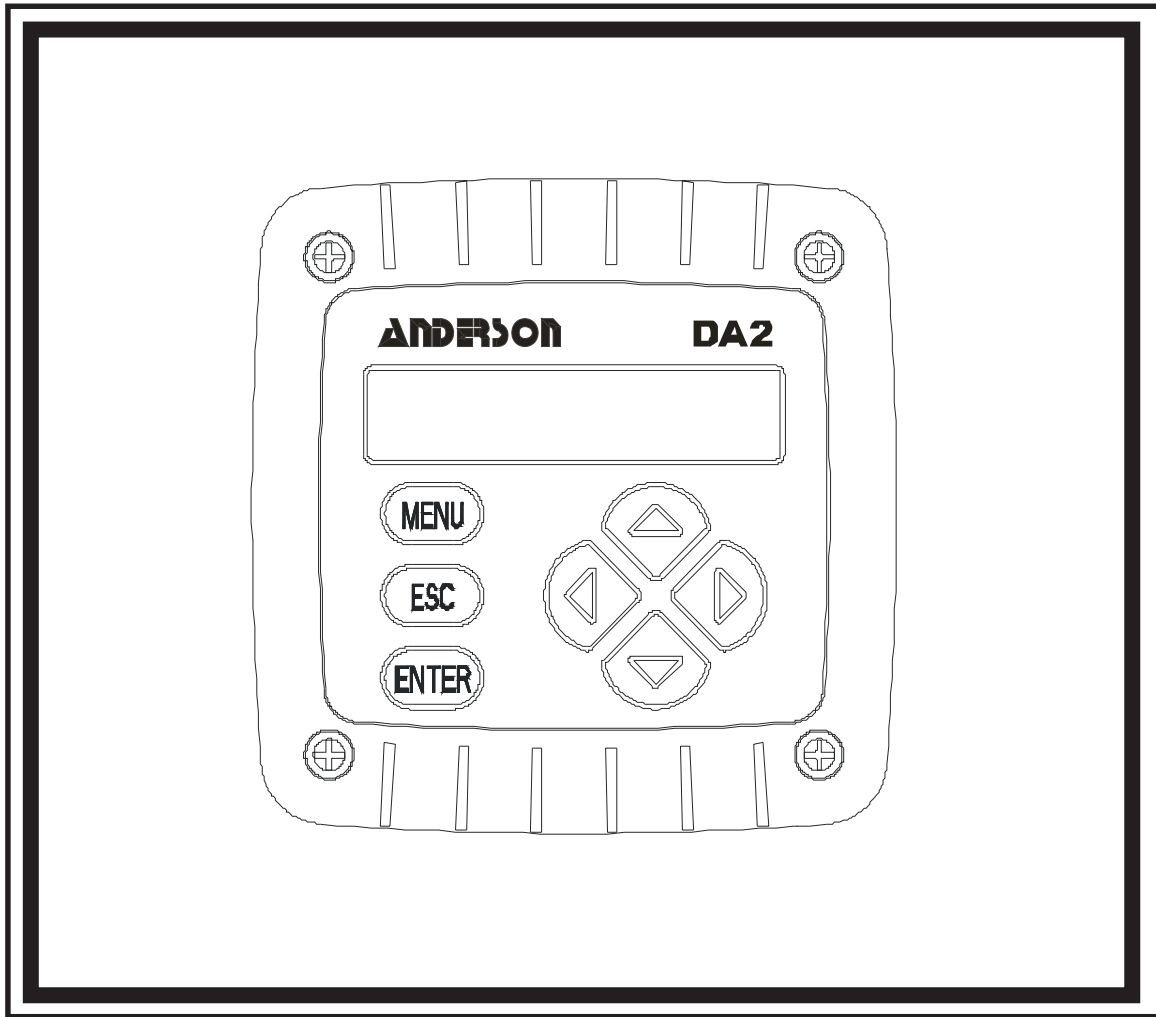

## **Model DA2 ELECTRODLESS CONDUCTIVITY TRANSMITTER**

(for conductivity, % concentration and TDS measurement)

---

## **Table of Contents**

<b>Section 1 - General Information .....</b>	<b>4</b>
1.1 Capability Highlights .....	4
1.2 Transmitter Safety .....	4
1.3 Retained Configuration Values .....	5
1.4 Transmitter Serial Number .....	5
1.5 EMC Conformance .....	5
<b>Section 2 - Specifications .....</b>	<b>6</b>
2.1 Operational .....	6
2.2 Transmitter Performance (Electrical, Analog Outputs) .....	8
2.3 Mechanical .....	8
<b>Section 3 - Physical Installation .....</b>	<b>9</b>
3.1 Location .....	9
3.2 Panel Mounting (DA201A) .....	10
3.3 Wall and Pipe Mounting (DA202A) .....	11
3.4 Integral Sensor Mounting (DA202A with HC1012000 only) .....	12
<b>Section 4 - Electrical Connections .....</b>	<b>13</b>
4.1 HC1 Series Electroless Conductivity Sensor Wiring .....	14
4.2 Two-Wire Hookup .....	15
4.3 Three-Wire Hookup .....	16
4.4 Four-Wire Hookup .....	17
<b>Section 5 - Operation .....</b>	<b>18</b>
5.1 Display .....	18
5.2 Keypad .....	18
5.3 MEASURE Screen (normal display mode) .....	20
<b>Section 6 - Menu Structure .....</b>	<b>21</b>
6.1 Displaying Main Branch Selection Screens .....	21
6.2 Displaying Top-Level Menu Screens .....	22
6.3 Displaying Submenu Screens .....	23
6.4 Adjusting Edit / Selection Screen Values .....	23
6.5 Entering (Storing) Edit/Selection Screen Values/Choices .....	23

**Section 7 - Transmitter Configuration .....24**

- 7.1 Selecting Language to Operate Transmitter ..... 24
- 7.2 Configuring Sensor Characteristics ..... 24
- 7.3 Set °C OR °F (temperature display format) ..... 34
- 7.4 Configuring Analog Output ..... 34
- 7.5 SET Passcode (feature enabled or disabled) ..... 36
- 7.6 Configuration Setting Summary ..... 38

**Section 8 - Transmitter Calibration .....40**

- 8.1 Important Information ..... 40
- 8.2 Zero Procedure (first-time sensor calibration only) ..... 41
- 8.3 Conductivity Calibration ..... 41
- 8.4 % Concentration Calibration ..... 45
- 8.4 TDS Calibration ..... 47
- 8.6 Analog Output Calibration ..... 49

**Section 9 - Testing & Maintenance .....50**

- 9.1 STATUS Check (transmitter and sensor) ..... 50
- 9.2 HOLD OUTPUT ..... 51
- 9.3 OUTPUT Test Signal ..... 51
- 9.4 Firmware (EPROM VERSION) Check ..... 51
- 9.5 SELECT SIM Measurement ..... 52
- 9.6 SIM SENSOR Setting ..... 52
- 9.7 RESET CONFIGURE Values to Factory Defaults ..... 53
- 9.8 RESET CALIBRATE Values to Factory Defaults ..... 53

**Section 10 - Troubleshooting .....54**

- 10.1 Keeping the Transmitter Calibrated ..... 54
- 10.2 Avoiding Electrical Interference ..... 54
- 10.3 Checking Electrical Connections ..... 54
- 10.4 Verifying Sensor Operation ..... 54
- 10.5 Verifying Transmitter Operation ..... 54
- 10.6 Verifying Interconnect Cable Integrity ..... 55

**Section 11 - Ordering Matrix .....55**

**Section 12 - Warranty and Return Statement .....56**

---

## Section 1 - General Information

### 1.1 Capability Highlights

#### Sensor Input

The transmitter can be used with the Model HC1-Series electrodeless conductivity sensor. These sensors have a built-in Pt 1000 RTD temperature compensator element.

#### MEASURE Screen

The measure screen (normal display mode) can provide different readouts of measured data. With the MEASURE screen displayed, press  $\leftarrow$  OR  $\rightarrow$  to show:

- Measured conductivity, % concentration or TDS
- Measured temperature ( $^{\circ}\text{C}$  or  $^{\circ}\text{F}$ )
- Measured conductivity, % concentration or TDS and temperature
- Measured analog output value (mA)
- Uncompensated conductivity corresponding to concentration readout (only shown when transmitter is set to measure concentration)

#### Password-Protected Access

For security, you can enable a passcode feature to restrict access to configuration and calibration settings to authorized personnel only. See Section 7.5 for details.

#### Calibration Methods

Because each sensor has a unique zero point and span, always zero the sensor in air when calibrating it for the first time (Section 8.2). Depending on the configured measurement (conductivity, % concentration or TDS), different methods are available for calibrating sensor span (see Section 8.3, 8.4 or 8.5 respectively). The analog output loop can also be calibrated (Section 8.6).

#### Analog Output

The transmitter's isolated 4-20 mA analog output can be assigned to represent one of these:

- Measured conductivity, % concentration or TDS
- Measured temperature.

Parameter values can be entered to define the endpoints at which the 4 mA and 20 mA analog output values are desired (range expand). For analog output setup details, see Section 7.4.

*NOTE: During calibration, the analog output is automatically held at the last measured value and, upon completion, returned to its active state.*

---

### 1.2 Transmitter Safety

The transmitter is completely safe to handle. Only low DC voltage is present.

**1.3 Retained Configuration Values**

All user-entered configuration values are retained indefinitely, even if power is lost or turned off. The non-volatile transmitter memory does not require battery backup.

**1.4 Transmitter Serial Number**

A label with the transmitter model number, serial number, and build date is located between the terminal blocks.

**1.5 EMC Conformance**

The transmitter is designed to provide protection from most normally encountered electromagnetic interference. This protection exceeds U.S. standards and meets European IEC 1000 (EN 61000) series testing for electromagnetic and radio frequency emissions and immunity. Refer to Figure 1-1 and the specifications in Section 2.1 for more information.

Figure 1-1 EMC Diagram

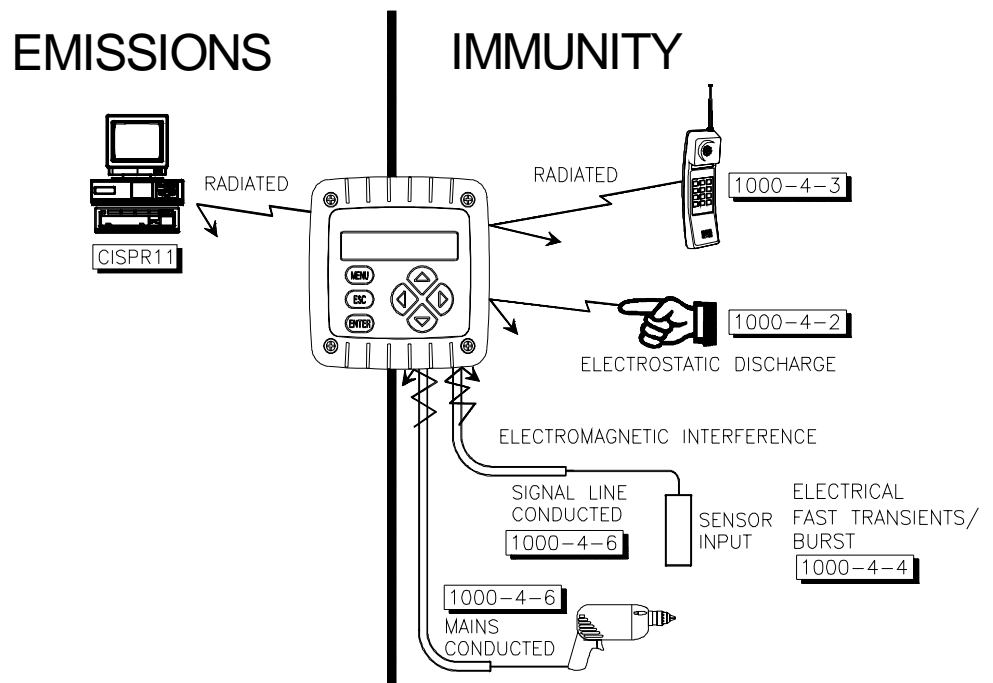

---

## **Section 2 - Specifications**

### **2.1 Operational**

Display Two-line by 16 character LCD

*NOTE: The measured value (conductivity, % concentration or TDS) and temperature can be displayed separately or shown together on a single screen. The corresponding 4-20 mA analog output value can also be shown. (When measuring concentration, the transmitter can also show a corresponding readout of uncompensated conductivity.)*

<b>Measurement</b>	<b>Ranges</b>
Conductivity	$\mu\text{S/cm}$ : 0-200.0 or 0-2000 $\text{mS/cm}$ : 0-2.000, 0-20.00, 0-200.0 or 0-2000 $\text{S/cm}$ : 0-2.000
% Concentration	0-99.99% or 0-200.0%
TDS	0-9999 ppm
Temperature	-4.0 to 347.0°F or -20.0 to +175.0°C
Analog Output	4.00-20.00 mA

#### **Ambient Conditions:**

Operation	-4 to +140°F (-20 to +60°C); 0-95% relative humidity, non-condensing
Storage	-22 to +158°F (-30 to +70°C); 0-95% relative humidity, non-condensing
Temperature Compensation	Automatic from 14.0 to 347.0°F (-10.0 to +175.0°C) with selection for Pt 1000 ohm RTD temperature element, or manually fixed at a user-set temperature

*NOTE: The selected measurement (conductivity, % conc. or TDS) determines which of the following temperature compensation methods are available:  
Linear % per °C slope, built-in natural water temperature properties table, user-entered temperature table, or no compensation*

Sensor-to-Transmitter Distance Maximum cable length is a function of the measuring range and allowable non-linearity. The following schedule is recommended:

<u>Full-scale Range</u>	<u>Max. Length</u>
200 to 2000 $\mu\text{S/cm}$	200 ft. (61 m)
2000 to 2,000,000 $\mu\text{S/cm}$	300 ft. (91 m)

*NOTE: When measuring % concentration, convert the transmitter full-scale value to conductivity to determine the maximum distance.*

**Power Requirements (Class 2 Power Supply):**

Two-wire Hookup	16-30 VDC
Three-wire Hookup	14-30 VDC
Four-wire Hookup	12-30 VDC

**Calibration Methods:**

Sensor Zero (all measurements)	With the dry sensor in air, press keys to initiate automatic system zeroing
-----------------------------------	---

**Conductivity Measurement:**

COND CAL	Enter compensation reference temperature, and reference solution's known linear % per °C slope and value
SAMPLE CAL	Enter one sample value (determined by laboratory analysis or a comparison reading)
ELECTRONIC CAL	This method requires that the sensor be removed from the process and utilizes a decade resistance box to simulate conductivity rather than an actual solution.

**Concentration Measurement:**

CONC CAL	Enter one sample value (determined by laboratory analysis or a comparison reading)
COND CAL	Enter compensation reference temperature, and reference solution's known linear % per °C slope and value

**TDS Measurement:**

TDS CAL	Enter one sample value (determined by laboratory analysis or a comparison reading)
---------	--

Analog Output    Isolated 4-20 mA output with 0.004 mA (12-bit) resolution

*NOTE: The output can be assigned to represent the measured value (conductivity, % concentration or TDS) or measured temperature. Parameter values can be entered to define the endpoints at which the 4 mA and 20 mA output values are desired (range expand). During calibration, the output is automatically held at the last measured value and, upon completion, returned to its active state.*

Maximum Loop Load	Dependent on power supply voltage, transmitter hookup arrangement, and wire resistance (see load resistance charts for respective hookup diagrams in Section 4.2, 4.3 or 4.4)
Memory (non-volatile)	All user settings are retained indefinitely without battery backup
Electrical Certifications	UL, C-UL Pending

---

## 2.2 Transmitter Performance (Electrical, Analog Outputs)

Accuracy*	± 0.1% of span
Sensitivity*	± 0.05% of span
Repeatability*	± 0.05% of span
Temperature Drift*	Zero and Span: ± 0.02% of span per °C
Response Time	1-60 seconds to 90% of value upon step change (with sensor filter setting of zero)

\*These typical performance specifications are:

1. Based on 25°C with conductivity of 500 µS/cm and higher. Consult factory for applications in which conductivities are less than 500 µS/cm.
2. Derated above 100°C to the maximum displayed temperature of 200°C. Consult factory for details.

---

## 2.3 Mechanical

Enclosure	Polycarbonate; NEMA 4X general purpose; choice of included mounting hardware
Mounting Configurations	Panel, wall, pipe or integral sensor mounting
Dimensions	With Back Cover: 3.75 in. W x 3.75 in. H x 2.32 in. D (95 mm W x 95 mm H x 60 mm D)  Without Back Cover for Panel Mount: 3.75 in. W x 3.75 in. H x 0.75 in. D (95 mm W x 95 mm H x 19 mm D)
Net Weight	10 oz. (280 g) approximately



---

## Section 3 - Physical Installation

Unpack and examine the equipment even if you do not use it immediately. If there is evidence of damage, notify the transit carrier immediately.

Recommendation: Save the shipping carton and packing materials in case the instrument must be stored or re-shipped.

### 3.1 Location

1. It is recommended to locate the transmitter as close as possible to the installed sensor. The maximum allowable distance between an installed sensor and the transmitter depends upon the full-scale value you set for the transmitter measuring range:

200-2000 $\mu\text{S/cm}$ Full-scale Value	2000-2,000,000 $\mu\text{S/cm}$ Full-scale Value
200 feet (61 m) max.	300 feet (91 m) max.

*NOTE: When measuring % concentration, convert the transmitter full-scale value to conductivity to determine the maximum distance.*

2. *Mount the transmitter in a location that is:*
  - Clean and dry where there is little or no vibration.
  - Protected from corrosive fluids.
  - Within ambient temperature limits (-4 to +140°F or -20 to +60°C).

**CAUTION:**  
EXPOSING THE TRANSMITTER TO DIRECT SUNLIGHT MAY INCREASE THE OPERATING TEMPERATURE ABOVE ITS SPECIFIED LIMIT, AND DECREASE DISPLAY VISIBILITY.

## 3.2 Panel Mounting (DA201A)

Figure 3-1 illustrates how to panel mount the transmitter using the supplied panel mount hardware kit.

1. Cut a 3.30-inch (84 mm) square cutout hole in panel.
2. Position panel-mount gasket over cutout in front of panel, and place retainer plate behind panel with its four threaded inserts facing away from back of panel.
3. Attach transmitter to retainer plate using its four captive screws.

**NOTE:** If panel is too thick, remove captive screws from transmitter, and use longer screws provided in hardware kit.

FIGURE 3-1 Panel Mounting Details (DA201A)

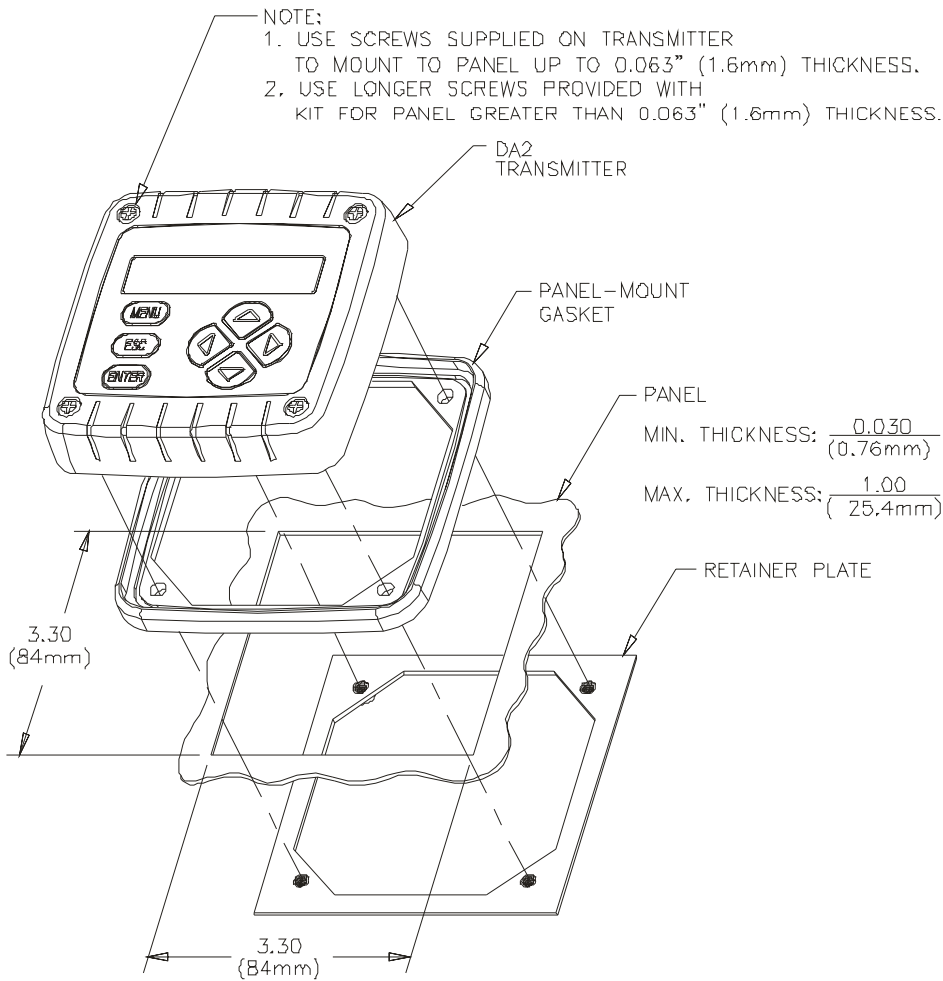

### 3.3 Wall and Pipe Mounting (DA202A)

Figure 3-2 illustrates how to wall or pipe mount the transmitter using the supplied hardware kit. Determine the mounting method, and attach the hardware as shown.

1. Fasten the wall/pipe adapter to the wall or pipe.
2. Using a blunt tool, open both cable entry knockout holes in the back cover.
3. Insert-and-twist the back cover onto the installed wall/pipe adapter, and tighten its two screws to lock back cover onto the adapter.
4. Attach transmitter to back cover using its four captive screws.

FIGURE 3-2 Wall and Pipe Mounting (DA202A)

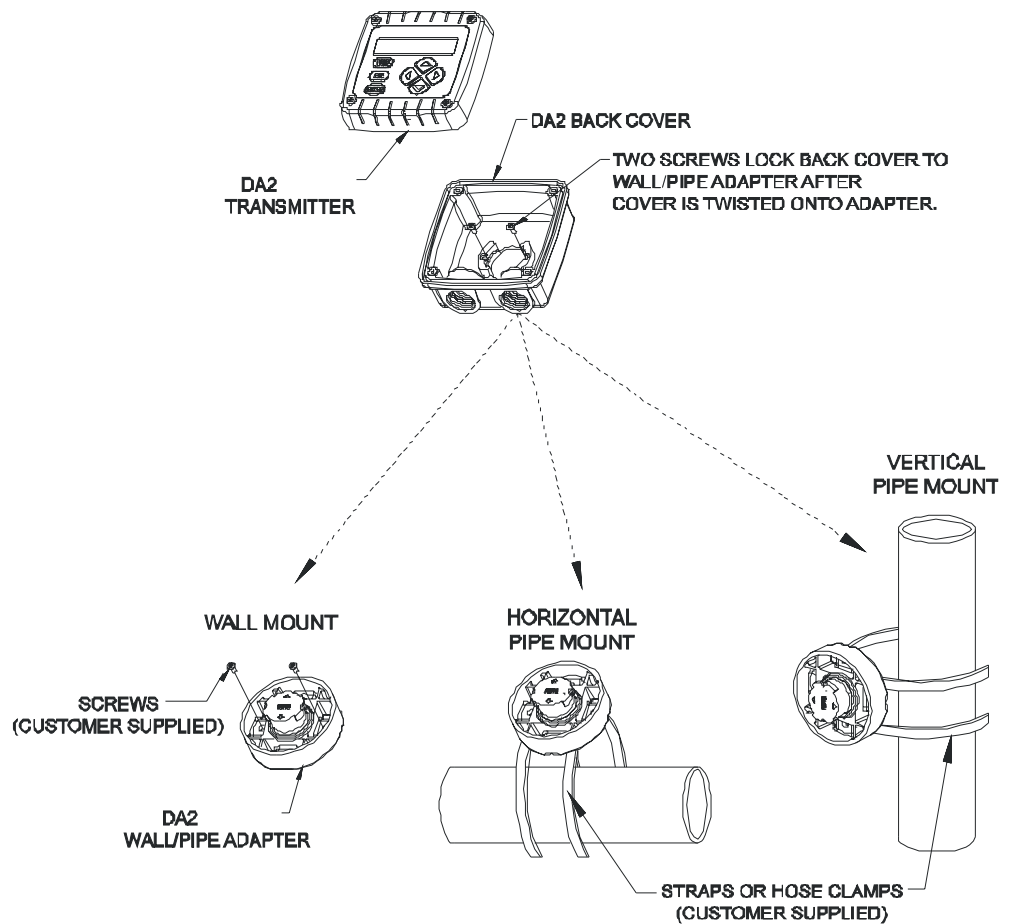

**3.4 Integral Sensor Mounting (DA202A with HC1012000 only)**

Figure 3-3 illustrates how to integrally mount the transmitter onto a sensor using the supplied mounting hardware kit.

1. Using a blunt tool, open knockout hole in bottom of swivel ball for routing the sensor cable.
2. Attach swivel-mount assembly onto back end of sensor using a stainless steel 1/2" NPT female close coupling that you provide. Be sure to tape the NPT threads to prevent moisture ingress.
3. Insert-and-twist the back cover onto the installed swivel-mount assembly. Tighten its two screws to lock the back cover onto the swivel-mount assembly.

*NOTE: To change mounting angle, loosen swivel-mount assembly by lifting tab on bottom of swivel nut. Position to desired angle and re-tighten swivel nut.*

4. Attach transmitter to back cover using its four captive screws.

FIGURE 3-3 Integral Sensor Mounting (DA202A)

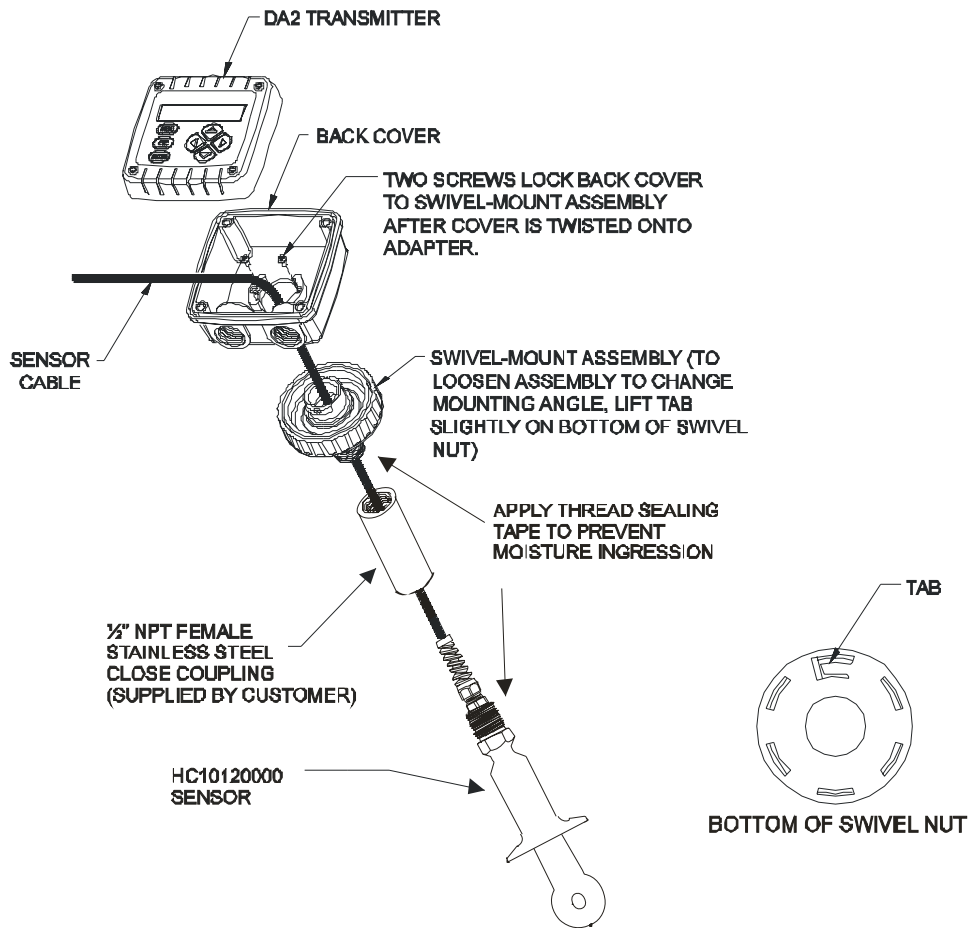

## Section 4 - Electrical Connections

Figure 4-1 shows the terminal block arrangement and terminal designations for the transmitter.

**NOTE:** All terminals are suitable for single wires up to 14 AWG (2.5 mm2).

**Wiring Tip!** To comply with European Community (CE) electromagnetic compatibility requirements, follow these general wiring guidelines:

1. Locate transmitter as far as possible from motors and other non-CE certified devices with excessive electromagnetic emissions.
2. Use specified ferrites and cables. Failure to do so may eliminate compliance. Locate all ferrites as close as possible to the transmitter.
  - DC Power Supply Cable: Connect cable shield to earth ground at the supply end. Loop cable 2-1/2 times through ferrite (Steward #28B0686-200, Fair-Rite Corp. #2643665702 or equivalent).
  - Sensor Cable: Keep cable shields as short as possible. At the transmitter end, connect the outer shield to earth ground, and the inner shield to the SHIELD terminal. Clamp ferrite (Steward #28A2025-OAO, Fair-Rite Corp. #0431164281, or equiv-alent) on sensor cable.
  - Analog mA Output Cable (four-wire hookup only): Connect cable shield to earth ground at the supply end. Loop cable 2-1/2 times through ferrite (Steward #28B0686-200, Fair-Rite Corp. #2643665702, or equivalent).

FIGURE 4-1 Transmitter Terminal Designations

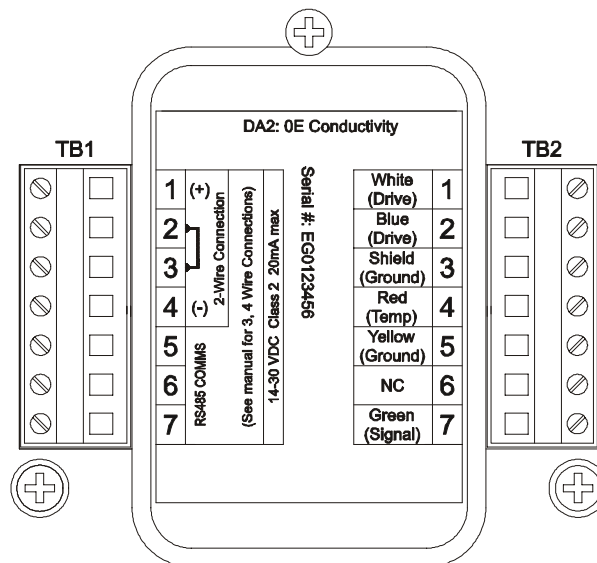

**4.1 HC1 Series Electrodeless Conductivity Sensor Wiring**

Depending on how transmitter is mounted, route the sensor (or interconnect) cable into the transmitter as follows:

- Wall/Pipe-mounted Transmitter: Route cable through left side cable entry knockout hole in the back cover.
- Panel-mounted Transmitter: Route cable behind panel to the exposed TB2 terminal strip.
- Integral Sensor-mounted Transmitter: Route cable through a 1/2" NPT female close coupler and then through the swivel ball knockout hole and center hole in back cover. (Do not open left side cable entry knockout hole in back cover.)

Wiring Tip! Route the sensor cable in 1/2-inch, grounded metal conduit to protect it from moisture, electrical noise, and mechanical damage.

For installations where the distance between sensor and transmitter exceeds the sensor cable length, indirectly connect the sensor to the transmitter using a junction box and interconnect cable.

*NOTE: Do not route the sensor cable in any conduit containing AC or DC power wiring ("electrical noise" may interfere with the sensor signal). Also, always re-calibrate the system when the cable length between sensor and transmitter changes.*

Refer to Figure 4-2 and connect the sensor (or interconnect) cable wires as shown, matching colors as indicated. (Terminal 6 is unused.)

*NOTE: For systems not requiring CE compliance and lacking an earth ground, connect the outer shield to Terminal 3 on TB2.*

FIGURE 4-2 Connecting HC1 Series Electrodeless Conductivity Sensor

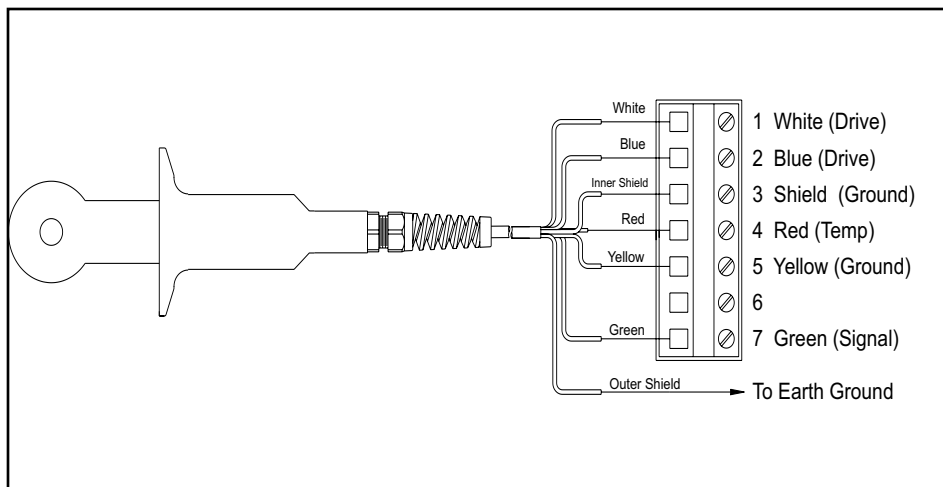

**4.2 Two-Wire Hookup**

In a two-wire hookup, at least 16 VDC is required for operation. A load device can be connected in the current loop (see Figure 4-3 for details).

Depending on how the transmitter is mounted, route the DC power/analog output wiring into the transmitter as follows:

- Wall/Pipe-mounted Transmitter: Route cable through right side cable entry knockout hole in the back cover.
- Panel-mounted Transmitter: Route cable behind panel to the exposed TB1 terminal strip.
- Integral Sensor-mounted Transmitter: Route cable through right side cable entry knockout hole in the back cover. (Do not open left side cable entry knockout hole in cover).

Wiring Tip! Use high quality, shielded instrumentation cable.

FIGURE 4-3 Two-Wire Hookup

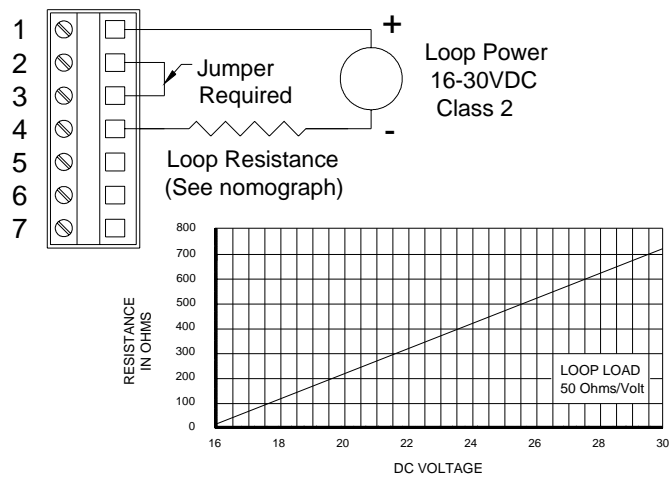

## 4.3 Three-Wire Hookup

In a three-wire hookup, the transmitter can be wired two ways depending on load “sinking” or “sourcing”. At least 14 VDC is required for operation.

Depending on how the transmitter is mounted, route the DC power, analog output, and wiring into the transmitter as follows:

- Wall/Pipe-mounted Transmitter: Route cable through right side cable entry knockout hole in the back cover.
- Panel-mounted Transmitter: Route cable behind panel to the exposed TB1 terminal strip.
- Integral Sensor-mounted Transmitter: Route cable through right side cable entry knockout hole in the back cover. (Do not open left side cable entry knockout hole in cover).

Wiring Tip! Use high quality, shielded instrumentation cable.

FIGURE 4-4 Three-Wire Hookup - Load Sinking

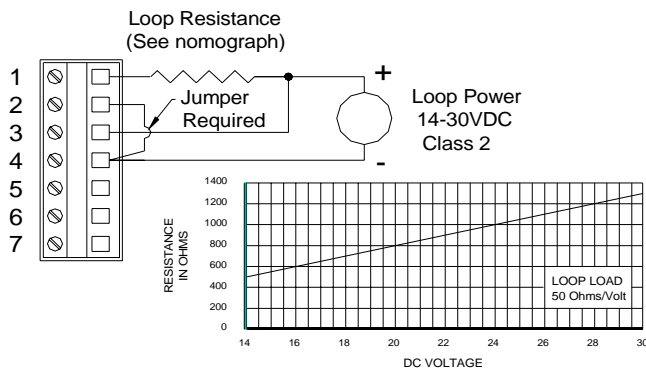
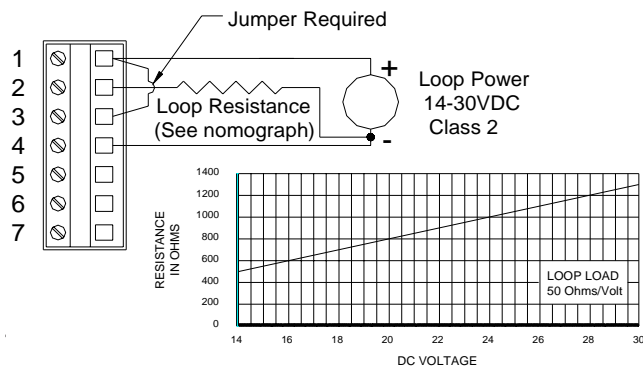

FIGURE 4-5 Three-Wire Hookup - Load Sourcing





#### 4.4 Four-Wire Hookup

In a four-wire hookup, at least 12 VDC is required for operation.

Depending on how the transmitter is mounted, route the DC power, analog output wiring into the transmitter as follows:

- Wall/Pipe-mounted Transmitter: Route cable through right side cable entry knockout hole in the back cover.
- Panel-mounted Transmitter: Route cable behind panel to the exposed TB1 terminal strip.
- Integral Sensor-mounted Transmitter: Route cable through right side cable entry knockout hole in the back cover. (Do not open left side cable entry knockout hole in cover).

Wiring Tip! Use high quality, shielded instrumentation cable

FIGURE 4-6 Four-Wire Hookup

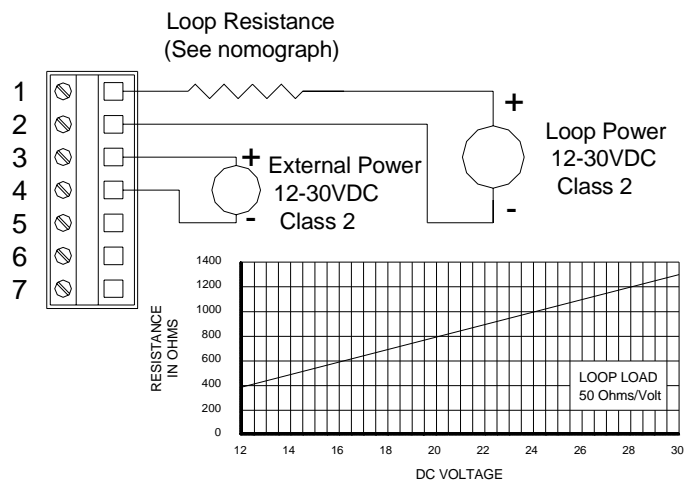

---

## Section 5 - Operation

The user interface consists of a two-line LCD display and a keypad with **MENU**, **ENTER**, **ESC**, **←**, **→**, **↑**, and **↓** keys.

---

### 5.1 Display

By using the keypad, you can display three types of screens:

1. **Measure Screens:** The normal display mode shows the measured value (conductivity, % concentration or TDS). Pressing the **→** key sequentially scrolls through these other measurement readouts:
  - Measured process temperature
  - Measured value and temperature
  - Measured analog output mA value
  - Uncompensated conductivity corresponding to % concentration readout (only shown when transmitter is set to measure concentration)
2. **MENU Screens:** These top-level and lower-level (submenu) screens within the three main branches of the menu tree are used to access edit/selection screens for configuration. (EXIT screens at the end of each menu branch enable you to move up one level in the menu tree by pressing the ENTER key. This is functionally the same as pressing the ESC key.)
3. **Edit/Selection Screens:** These screens enter values / choices to calibrate, configure, and test the transmitter.

---

### 5.2 Keypad

The keypad enables you to move throughout the transmitter menu tree. The keys and their related functions are:

1. **MENU key:** Pressing this key with the MEASURE screen displayed shows the “MAIN MENU ► CALIBRATE” screen. To display the configure or test/maint top-level main branch screen, press the **↓** key. Pressing the MENU key with a menu screen displayed always shows the top-level screen in that branch. (Pressing the MENU key also “aborts” the procedure to change values or selections.)
2. **ENTER key:** Pressing this key does two things; it displays submenu and edit/selection screens, and it enters (saves) configuration values/selections.
3. **ESC key:** Pressing this key always takes the display up one level in the menu tree. (Example: With any “MAIN MENU” screen displayed, pressing the ESC key once takes the display up one level to the measure screen.) The ESC key can also “abort” the procedure to change a value or selection.
4. **← and → keys:** Depending on the type of displayed screen, these keys do the following:
  - MEASURE Screen: Changes readout (in continuous loop sequence) to show different measurements.
  - Menu Screens: These keys are non-functional.
  - Edit/Selection Screens: Moves cursor left or right to select digit for adjustment with **↑** and **↓** keys.
5. **↑ and ↓ keys:** Depending on the type of displayed screen, these keys do the following:

- MEASURE Screen: These keys are non-functional.
- Menu Screens: Moves up or down respectively between other same-level menu screens.
- Edit/Selection Screens: Adjusts selected digit value up or down, or moves up or down between choices.

---

FIGURE 5-1 Transmitter Keypad

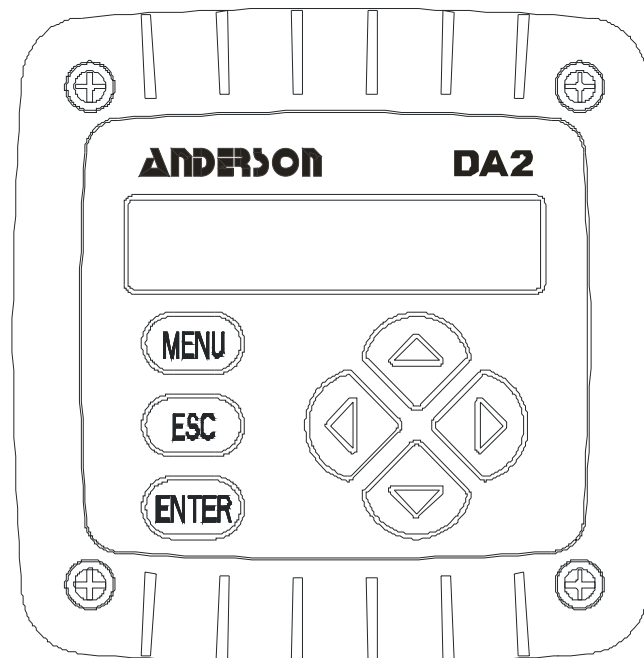

**5.3 MEASURE Screen (normal display mode)**

The MEASURE screen is normally displayed. Pressing the **MENU** key temporarily replaces the MEASURE screen with the top-level “MAIN MENU ► CALIBRATE” branch selection screen. Using the keypad, you can then display other screens to calibrate, configure or test the transmitter. **If the keypad is not used within 30 minutes, except during calibration or while using specific transmitter test/ maintenance functions, the display will automatically return to the MEASURE screen.** To display the measure screen at any time, press the **MENU** key once and then press the **ESC** key once.

The MEASURE screen can show four different readout versions. To select between them, in continuous loop sequence, press the **←** or **→** key. These are examples of the different versions:

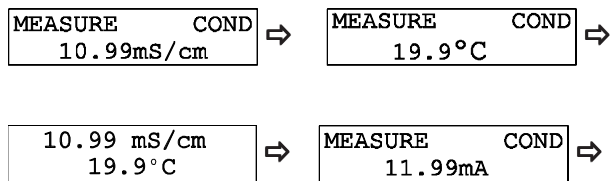

When set to measure concentration, the transmitter can also show an uncompensated conductivity reading corresponding to the measured concentration, as illustrated by this example:

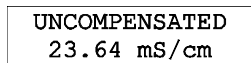

*NOTE: When the transmitter returns to its normal MEASURE screen mode, the appearing readout is always the version last selected.  
Note that three MEASURE screen readout examples show the factory-default “cond” notation on their top lines, illustrating the transmitter notation feature. To create your own notation, refer to Section 7.2, subheading “ENTER NOTE (top line of MEASURE screen).”*

When the measured value is beyond the transmitter measuring range, a series of “+” or “-” screen symbols appear, respectively indicating that the value is above or below range.

## Section 6 - Menu Structure

The transmitter menu tree is divided into three main branches: CALIBRATE, CONFIGURE, and TEST/MAINT. Each main branch is structured similarly in layers with top-level screens, related lower-level submenu screens and, in many cases, sub-submenu screens.

Each layer contains an EXIT screen to return the display up one level to the previous layer of screens.

**Menu Structure Tip!** For operating convenience, the layers within each main branch are organized with the most frequently used function screens at their beginning, rather than the function screens used for initial startup.

### 6.1 Displaying Main Branch Selection Screens

- With the MEASURE screen displayed, pressing the **MENU key** always shows the  branch selection screen. (Pressing the **MENU key** with any other type of screen displayed always returns the display to the top of that respective menu branch).
- Press **↓** and **↑** keys to select between the three MAIN MENU branch selection

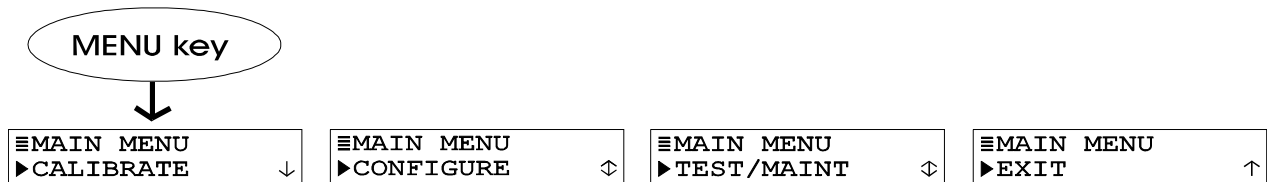

screens (CALIBRATE, CONFIGURE or TEST/MAINT), or the EXIT screen:

- With the desired MAIN MENU branch selection screen displayed, press **ENTER key** to display the first top-level menu screen within that branch.

**6.2 Displaying Top-Level Menu Screens**

With the first top-level menu screen of the desired main branch displayed, use the **↓** and **↑** keys to scroll through other top-level screens to access a desired screen.

The top-level menu screens for each main branch are:

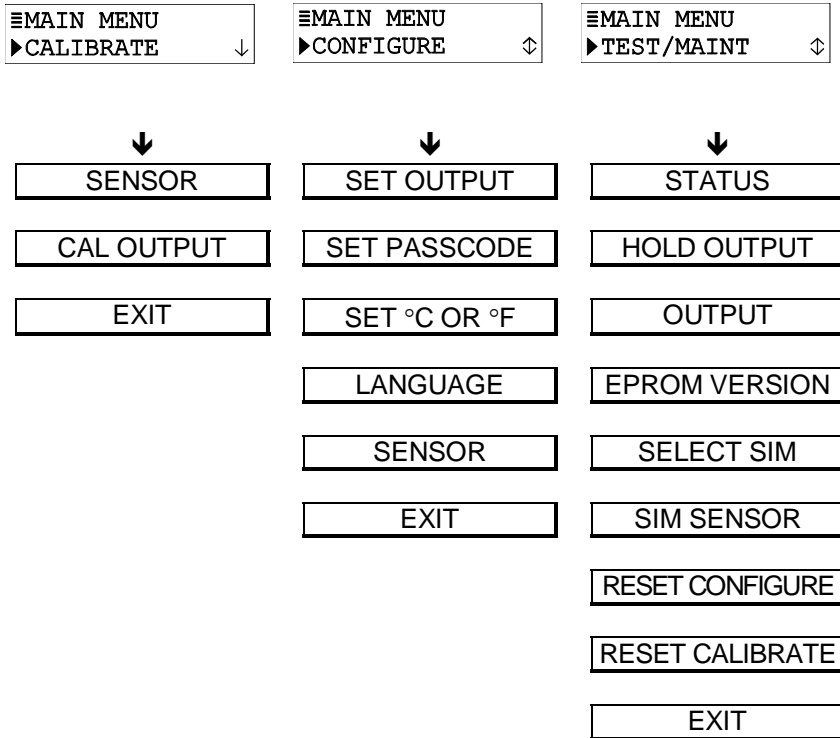

**Menu Structure Tip!** A menu screen with a horizontal bar symbol (|) at the start of its first line indicates there is a related submenu or edit/selection screen.

A menu screen with a ▶ symbol at the start and a “↓” symbol at the end of its second line indicates that you can select other screens within the same layer by pressing the **↓ key**. A “⇅” symbol at the end of the second line indicates that you can move up or down between screens by respectively pressing the **↑ or ↓ key**. When a “↑” symbol appears, it indicates you have reached the end of the screens in that layer. You can select previous screens using the **↑ key**.

### 6.3 Displaying Submenu Screens

After selecting a top-level menu screen, press the **ENTER** key to display a related submenu or edit/selection screen:

- **Submenu Screens** are usually linked to other related same-level screens. Pressing the **↓** key displays these other related submenu screens.

**Example:** With this submenu screen displayed:

```
≡SET OUTPUT
▶SET PARAMETER ↓
```

pressing the **↓** key displays this related, same-level submenu screen:

```
≡SET OUTPUT
▶SET 4mA VALUE ↕
```

- **Edit/Selection Screens** always have a first line ending with a "?". Pressing the **↑** or **↓** key changes the value/ choice enclosed by parenthesis (second line on screen).

**Example:** With this submenu screen displayed:

```
SET °C OR °F?
( °C )
```

pressing the **↓** key displays this related choice:

```
SET °C OR °F?
( °F )
```

### 6.4 Adjusting Edit / Selection Screen Values

Use **arrow keys** to edit/change the value/choice enclosed by parenthesis (examples shown above and below).

```
SET PARAMETER?
(SENSOR )
```

```
SET 4mA VALUE?
(10.22 uS/cm )
```

A choice can be changed by simply using the **↑** and **↓** keys. Numerical values can be adjusted using the **←** and **→** keys to select a digit, and **↑** and **↓** keys to adjust its value.

### 6.5 Entering (Storing) Edit/Selection Screen Values/Choices

With the desired value/choice displayed, press the **ENTER** key to enter (store) it into the non-volatile transmitter memory. The previous screen will then re-appear.

**NOTE:** You can always press the **ESC** key to abort saving a new setting. The original setting will be retained.

---



## Section 7 - Transmitter Configuration

**NOTE:** When the passcode feature is enabled (Section 7.5), you must successfully enter the passcode before attempting to enter a configuration setting.

---

### 7.1 Selecting LANGUAGE to Operate Transmitter

The transmitter is normally equipped to display screens in English and Spanish (Español). However, another language such as French (Français), German (Deutsche), etc. may be substituted for Spanish. The transmitter is factory-set for English. To select the other language:

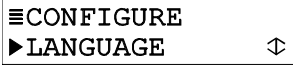
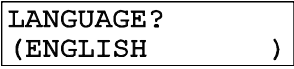
1. Press **MENU** key to display a “MAIN MENU” screen.  
If the  screen is not showing, use **↓** or **↑** key to display it.
2. Press **ENTER** key to display .
3. Press **↓** key until  screen appears.
4. Press **ENTER** key to display . Use **↓** or **↑** key to select a language, and press **ENTER** key to enter it.





**NOTE:** After a language is selected and entered, all screens are displayed in that language.

---

### 7.2 Configuring Sensor Characteristics

The transmitter must be configured to define the characteristics of the sensor including its temperature element type and “T” factor, and other related items such as selecting the measurement and its format, temperature compensation, input signal filtering, etc.

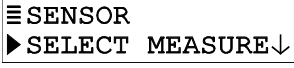
#### SELECT MEASURE (conductivity, concentration or TDS)

1. With the  screen displayed, press **↓** key once to display .
2. Press **ENTER** key to display .
3. Press **ENTER** key again to display a screen like . Use **↓** and **↑** keys to select the desired measurement (conductivity, concentration or TDS), and press **ENTER** key to enter it.

**NOTE:** If concentration was selected, measured conductivity must be converted to % concentration by selecting a **BUILT-IN** chemical concentration table or creating a **USER-DEFINED** table. See “CONFIG CONC” subheading for details.



WARNING:  
CHANGING THE MEASUREMENT AUTOMATICALLY REPLACES ALL  
USER-ENTERED CONFIGURATION VALUES WITH FACTORY-DEFAULTS.

**Select DISPLAY FORMAT**

After choosing the measurement, select the desired display format for the MEASURE screen. The selected units and resolution will also appear on all applicable edit/selection menu screens.

1. With the  screen displayed, press **↓ key once** to display

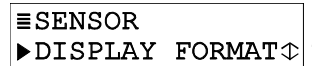

2. Refer to the selected measurement category below and follow its steps:

**Conductivity Display Format**

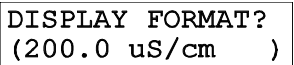
Press **ENTER key** to display a screen like . Use **↓ and ↑ keys** to select a format (2000 μS/cm, 200.0 μS/cm, 2.000 mS/cm, 20.00 mS/cm, 200.0 mS/cm, 2000 mS/cm, or 2.000 S/cm), and press **ENTER key** to enter it.

**CONCENTRATION Display Format**

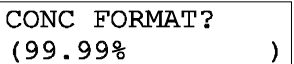
1. Press **ENTER key** to display .
2. Press **ENTER key** again to display a screen like . Use **↓ and ↑ keys** to select a format (99.99% or 200.0%), and press **ENTER key** to enter it.
3. After the screen re-appears, press **↓ key once** to display to format the uncompensated conductivity MEASURE screen readout (and select conductivity range for USER-DEFINED table, if used).
4. Press **ENTER key** to display a screen like . Use **↓ and ↑ keys** to select a format (same choices previously described for conductivity), and press **ENTER key** to enter it.

**TDS Display Format**

Display format configuration for TDS is always 0-9999 ppm. Consequently, there is no display format screen.

**Select Temperature COMPENSATION**

Configure the required type of temperature compensation for the selected measurement.

1. With the  screen displayed, press **↓ key once** to display

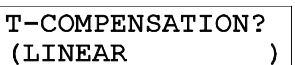

2. Press **ENTER key** to display a screen like . Use **↓ and ↑ keys** to select the type of compensation, and press **ENTER key** to enter it:

- **LINEAR:** Recommended for most aqueous solutions
- **NATURAL WATER (not available for TDS measurement):** Built-in temperature properties table only for special applications — consult factory)
- **TEMP TABLE:** User-defined temperature table
- **NONE:** Measurement values are not compensated

**NOTE:** LINEAR is the factory default for temperature compensation with a 2.00% per °C slope and 25.0°C reference temperature. This provides the best results for most aqueous solutions. To enter different slope and reference temperature values for an uncommon solution, refer to subheading “CONFIG LINEAR or CONFIG T-TABLE Temperature Compensation” for details.



**CONFIG CONC or CONFIG TDS Measurement (configuration not needed for conductivity)**

Only when CONCENTRATION or TDS is selected must the transmitter be further configured. If CONDUCTIVITY was selected, disregard this subsection — no measurement configuration is needed.

**CONCENTRATION Measurement Setup**

Configure the transmitter with an appropriate table to convert measured conductivity into displayed % concentration. If one of the transmitter’s BUILT-IN chemical concentration tables matches the solution being measured, simply select that table. If not, you must create a USER-DEFINED concentration table for the solution being measured.

**Selecting BUILT-IN Chemical Concentration Table**

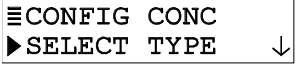
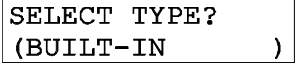
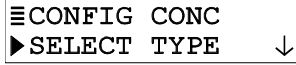
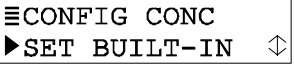
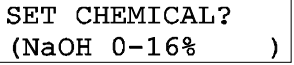
1. With the  screen displayed, press **↓ key once** to display .
2. Press **ENTER key** to display .
3. Press **ENTER key** again to display . BUILT-IN configures transmitter to use one of the built-in chemical concentration tables. (If screen shows USER-DEFINED, use **↓ and ↑ keys** to select BUILT-IN.)
4. With “BUILT-IN” displayed, press **ENTER key**.
5. After the  screen re-appears, press **↓ key once** to display .
6. Press **ENTER key** to display a chemical table selection screen like . Use **↓ and ↑ keys** to select the chemical concentration table that matches your solution, and press **ENTER key** to enter it:

Solution	Concentration	°C Range	Solution	Concentration	°C Range
NaOH	0-16%	0-100°C	H <sub>2</sub> SO <sub>4</sub>	40-80%	0-115°C
CaCl <sub>2</sub>	0-22%	15-55°C	H <sub>2</sub> SO <sub>4</sub>	93-99%	0-115°C
HNO <sub>3</sub>	0-28%	0-50°C	H <sub>3</sub> PO <sub>4</sub>	0-40%	0-75°C
HNO <sub>3</sub>	36-96%	0-50°C	HCl	0-18%	0-65°C
H <sub>2</sub> SO <sub>4</sub>	0-30%	0-115°C	HCl	22-36%	0-65°C

**Creating USER-DEFINED Concentration TABLE**

If the solution being measured does not match any BUILT-IN chemical table, create a USER-DEFINED table to convert measured conductivity into displayed % concentration.

**NOTE:** A USER-DEFINED table must contain at least two data points (Pt. 1 and Pt. 2) but can have up to ten. (More points improve measuring accuracy.) Each point must have a conductivity value coordinate (shown as X) and a corresponding % concentration value coordinate (shown as Y). The conductivity values and range are shown in units selected by the "DISPLAY COND FORMAT" screen. Conductivity values for each successive data point must increase. Concentration values, shown in their selected 99.99% or 200.0% display format, must be different from each other and always entered in order (increasing or decreasing). The table must be monotonic; that is, as conductivity values increase, concentration values must always increase or decrease.

Data Point	Conductivity Value (X coordinate)	% Concentration Value (Y coordinate)
Pt. 1	0 µS/cm	0.00%
Pt. 2	2000 µS/cm	99.99%

To create your own USER-DEFINED table, edit this default table and, if needed, add more points.

**Recommendation:** Before entering values, plan ahead and determine the conductivity and corresponding % concentration values for each data point in your table. Use TABLE B to conveniently organize and note your specific table entry values:

Data Point	Conductivity Value	% Concentration Value	Data Point	Conductivity Value	% Concentration Value
Pt. 1			Pt. 6		
Pt. 2			Pt. 7		
Pt. 3			Pt. 8		
Pt. 4			Pt. 9		
Pt. 5			Pt. 10		

**NOTE:** If the transmitter is calibrated, you can use the uncompensated conductivity MEASURE screen to determine corresponding conductivity values.

1. With the 

≡	SENSOR
▶	T-COMPENSATION

 screen displayed, press **↓ key once** to display 

≡	SENSOR
▶	CONFIG CONC

.
2. Press **ENTER key** to display 

≡	CONFIG CONC
▶	SELECT TYPE

.
3. Press **ENTER key** again to display 

SELECT TYPE?
( BUILT-IN )

. Use **↓ or ↑ key** to select “USER-DEFINED,” which configures the transmitter to use the special concentration table you create.
4. With “USER-DEFINED” displayed, press **ENTER key**.
5. After the screen re-appears, press **↓ key once** to display .
6. Press **ENTER key** to display a screen like . Using this screen and other similar data point screens, enter data to create your table:

**NOTE:** To switch between X and Y coordinate screens of a data point, use **↔ and ⇌ keys**. To move between data points of an X or Y coordinate, use **↓ and ↑ keys**.

- A. Press **ENTER key** to display a screen like 

X VALUE?
( 0 mS/cm )

. Use **arrow keys** to adjust the Point 1 conductivity value to an appropriate value, and press **ENTER key** to enter it.
- B. Press **⇌ key once** to display 

POINT 1 Y DATA ◀
0.00%

.
- C. Press **ENTER key** to display 

Y VALUE?
( 0.00% )

. Use **arrow keys** to adjust the Point 1 % concentration value to correspond with the Point 1 conductivity value, and press **ENTER key** to enter it.
- D. Press **↓ key once** and **↔ key once** to display a screen like 

POINT 2 X DATA ▶
2 mS/cm

.
- E. Repeat steps 6A through 6D to enter the conductivity and corresponding % concentration values for each remaining data point in the table.
- F. After all X and Y coordinate values are entered for each data point in the table, press **ESC key once** to display 

USER DEFINED
EXIT TABLE?

.
- G. Press **ENTER key** to display 

USER DEFINED
SAVE CHANGES?

.
- H. Press **ENTER key** again to save the table.

**NOTE:** If the table contains unacceptable coordinate values, the display shows a “CONFIRM FAILURE” message. Pressing **ENTER key** displays the unacceptable coordinate(s)

### TDS Measurement Setup

Define the conductivity-to-TDS conversion factor:

1. With the  screen displayed, press **↓ key** once to display

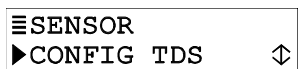

2. Press **ENTER key** to display .

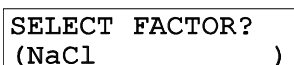
3. Press **ENTER key** again to display . Use **↓** and **↑** keys to select a conversion factor, and press **ENTER key** to enter it:

- **NaCl:** Built-in NaCl conductivity-to-TDS conversion factor.
- **USER DEFINED:** Conductivity-to-TDS conversion factor set by user (see step 4).

4. If “USER DEFINED” was selected, you must set a conductivity-to-TDS conversion factor:

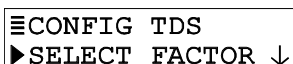
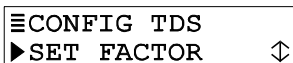
A. With the  screen displayed, press **↓ key** once to display .

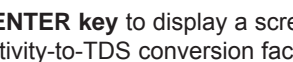
B. Press **ENTER key** to display a screen like . Use **arrow keys** to adjust to a desired conductivity-to-TDS conversion factor, and press **ENTER key** to enter it.

C. After the screen re-appears, press **ESC key** once to return to the  screen.

### CONFIG LINEAR or CONFIG T-TABLE Temperature Compensation (configuration not needed for other compensation methods)

**Only when LINEAR or TEMP TABLE is the selected temperature compensation, must the transmitter be further configured.** If the built-in NATURAL WATER properties table or NONE was selected, disregard this subsection — no compensation configuration is needed.

#### LINEAR Compensation Setup

Factory defaults for LINEAR compensation are 2.00%/°C slope and 25.0°C reference temperature. **These values are appropriate for most aqueous solutions.** Use chemical handbook tables to find values for uncommon solutions. To enter different values:

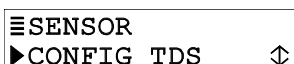
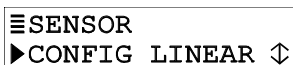
1. With the  or  screen displayed, press **↓ key** until  screen appears.

2. Press **ENTER key** to display .

3. Press **ENTER** key again to display a screen like 

SET SLOPE? (2.00 %/°C)
---------------------------

. Use **arrow keys** to adjust to a desired slope, and press **ENTER** key to enter it.
  
4. After the 

≡CONFIG LINEAR ▶SET SLOPE ↓
--------------------------------

 screen re-appears, press **↓** key once to display 

≡CONFIG LINEAR ▶SET REF TEMP ⇅
-----------------------------------

.
  
5. Press **ENTER** key to display a screen like 

SET REF TEMP? (25.0 °C)
----------------------------

. Use **arrow keys** to adjust to a desired reference temperature, and press **ENTER** key to enter it.
  
6. After the 

≡CONFIG LINEAR ▶SET REF TEMP ⇅
-----------------------------------

 screen re-appears, press **ESC** key once to return to the 

≡SENSOR ▶CONFIG LINEAR ⇅
-----------------------------

 screen.

**TEMP TABLE Compensation Setup**

When special temperature compensation is required, you can create your own temperature table to define the temperature compensation curve.

**NOTE:** *The TEMP TABLE must contain at least two data points (Pt. 1 and Pt. 2) but can have up to ten. (More points improve temperature compensation accuracy.) Each point must have a temperature value coordinate (shown as X) and a corresponding ratio coordinate (shown as Y). Temperature values must be between 0.0 and 200.0°C (or 32.0 and 392.0°F). Each entered temperature value must be different from all others. Entered ratios, which are unit-less, must be between 0.00 and 99.99 and can have the same value.*

*Use this equation to calculate the ratio value for each corresponding temperature value:*

$$\text{Ratio Value (for each corresponding temperature)} = \frac{\text{Cond. Value at Ref. Temp.}}{\text{Cond. Value at Noted Temp.}}$$

**Example:** Suppose the uncompensated or raw conductivity values are 100 mS/cm at a 25°C reference temperature, 120 mS/cm at 50°C, and 70 mS/cm at 15°C. Using this equation, ratio values for each of the corresponding temperatures are:

For 25°C, ratio value = 100 / 100 or 1.00

For 50°C, ratio value = 100 / 120 or 0.83

For 15°C, ratio value = 100 / 70 or 1.43

The default TEMP TABLE is:

Data Point	Temperature Value (X coordinate)	Corresponding Ratio Value (Y coordinate)
Pt. 1	0.0°C	1.00
Pt. 2	100.0°C	1.00

To create your own TEMP TABLE, edit this default table and, if needed, add more data points.

**Recommendation:** Before entering values, plan ahead and determine the temperature and ratio values for each data point in your table. Use TABLE C to conveniently organize and note your specific table entry values:

TABLE C -- Values for TEMP TABLE							
Data Point	°C Temp. (X)	Raw Cond.Value	Ratio Value (Y)	Data Point	°C Temp. (X)	Raw Cond. Value	Ratio Value (Y)
Pt. 1				Pt. 6			
Pt. 2				Pt. 7			
Pt. 3				Pt. 8			
Pt. 4				Pt. 9			
Pt. 5				Pt. 10			

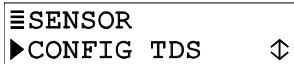
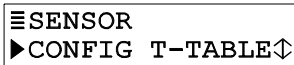
1. With the  or  screen displayed, press **↓** key until  screen appears.

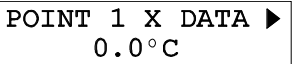
2. Press **ENTER** key to display a screen like . Using this screen and other similar data point screens, enter data to create your table:

**NOTE:** To switch between X and Y coordinate screens of a data point, use **↓** and **↑** keys. To move between data points of an X or Y coordinate, use **←** and **→** keys.

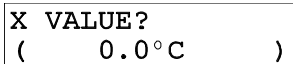
A. Press **ENTER** key to display a screen like . Use **arrow** keys to adjust the Point 1 temperature to an appropriate value, and press **ENTER** key to enter it.

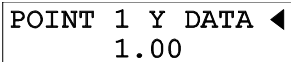
B. Press **→** key once to display .

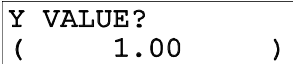
C. Press **ENTER** key to display . Use **arrow** keys to adjust the Point 1 ratio to match the calculated value corresponding to the Point 1 temperature, and press **ENTER** key to enter it.

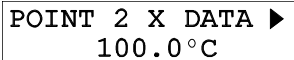
D. Press **↓** key once and **←** key once to display .

E. Repeat steps 2A through 2D to enter the temperature and corresponding calculated ratio values for each remaining data point in the table.

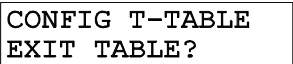
F. After all X and Y coordinate values are entered for each data point in the table, press **ESC** key once to display .

G. Press **ENTER** key to display 

CONFIG T-TABLE SAVE CHANGES?
---------------------------------

.

H. Press **ENTER** key again to save the table.

**NOTE:** If the table contains unacceptable coordinate values, the display shows a “CONFIRM FAILURE” message. Pressing **ENTER** key displays the unacceptable coordinate(s).

**Set FILTER time**

A time constant (in seconds) can be set to filter or “smooth out” the sensor signal. A minimum value of “0 seconds” has no smoothing effect. A maximum value of “60 seconds” provides maximum smoothing. Deciding what sensor signal filter time to use is a compromise. The higher the filter time, the longer the sensor signal response time will be to a change in the actual process value.

1. With the 

≡SENSOR ▶CONFIG LINEAR ⏴
-----------------------------

 or 

≡SENSOR ▶CONFIG T-TABLE⏴
-----------------------------

 screen displayed, press **↓** key once to display 

≡SENSOR ▶SET FILTER ⏴
--------------------------

.

2. Press **ENTER** key to display a screen like 

SET FILTER? ( 0 SECONDS )
------------------------------

. Use **arrow** keys to adjust to a desired filter time, and press **ENTER** key to enter it.

**ENTER NOTE (top line of MEASURE screen)**

The top line of the MEASURE screen readouts that separately show the measurement, temperature, and analog output values are factory set to read “COND.” This notation can be changed, for example, to “BASIN 1” to tailor the transmitter MEASURE screen to the application. The top line would then be “MEASURE BASIN 1.” The notation is limited to eight characters which can be a combination of capital letters A through Z, numbers 0 through 9, spaces, # symbols, hyphens, and periods.

1. With the 

≡SENSOR ▶SET FILTER ⏴
--------------------------

 screen displayed, press **↓** key once to display 

≡SENSOR ▶ENTER NOTE ⏴
--------------------------

.

2. Press **ENTER** key to display 

ENTER NOTE? ([C]OND )
--------------------------

.  
Create the desired notation on the second line:

- A. Starting with extreme left character position, use **↑** and **↓** keys to select the desired first character.
- B. Press **⇒** key once to select the next character, and use **↑** and **↓** keys to select its desired character.
- C. Repeat procedure until desired notation is displayed.

3. Press **ENTER** key to enter the displayed notation.





**Select TEMP ELEMENT Type**

The temperature element type is factory-set to “PT1000” for automatic temperature compensation (defines built-in temperature element in electrodeless conductivity sensors).

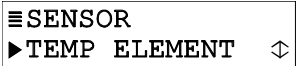

**NOTE:** When “PT1000” is selected but the element is not connected to the transmitter, a “WARNING: CHECK STATUS” message will appear. To prevent or clear this message, connect the element or select “MANUAL.”

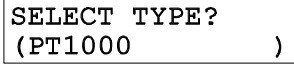
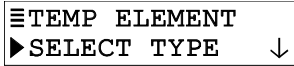
To configure the transmitter for fixed MANUAL temperature compensation you must select “MANUAL” and enter a specific temperature:



1. With the  screen displayed, press **↓ key once** to display .
2. Press **ENTER key** to display .
3. Press **ENTER key** again to display . Use **↓ key** to select “MANUAL” for fixed manual temperature compensation, and press **ENTER key** to enter it:
4. Now determine and enter a specific manual temperature compensation value:
  - A. With the  screen displayed, press **↓ key once** to display .
  - B. Press **ENTER key** to display a screen like . Use **arrow keys** to adjust to a desired temperature for fixed MANUAL compensation, and press **ENTER key** to enter it.

**SET T FACTOR (sensor’s factory-certified “T” factor)**

Each sensor is tested to provide a unique, certified temperature T FACTOR because:

- Temperature greatly affects conductivity measurement accuracy.
- The inherent ohm value of the Pt 1000 RTD temperature element varies slightly from sensor to sensor, affecting temperature measurement accuracy.

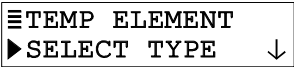
By entering the sensor’s unique T FACTOR, the transmitter will provide the highest possible measuring accuracy for both temperature and conductivity.

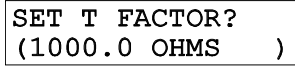
1. With the  screen displayed, press **↓ key once** to display .
2. Press **ENTER key** to display a screen like . Use **arrow keys** to adjust the displayed value to exactly match the sensor’s factory-certified T FACTOR, and press **ENTER key** to enter it.

**SPECIAL CASE — ALTERED SENSOR CABLE LENGTH**

Changing the standard 20 ft. (6 m) sensor cable length, by shortening it or adding an interconnect cable, affects temperature measuring accuracy. The factory-certified T factor is based on standard cable length. To compensate for altered cable length measuring error, change the certified T factor entry:

Shortened Sensor Cable: To increase the transmitter temperature reading to match the known solution temperature, decrease the T factor by 3.85 ohms for each °C difference.

Added Interconnect Cable: To decrease the transmitter temperature reading to match the known solution temperature, increase the T factor by 3.85 ohms for each °C difference.

**Example:** Suppose the known solution temperature is 50°C and the transmitter reads 53°C due to interconnect cable resistance. Multiply the 3°C difference by 3.85 ohms to get 11.55. Then increase the sensor T FACTOR by adding 11.55 to it and entering that value. If, due to a shortened sensor cable, the transmitter was reading 3°C less than the known solution temperature you would decrease the sensor T FACTOR by subtracting 11.55 from it.

- After the 

≡TEMP ELEMENT
▶SET T FACTOR

 screen re-appears, press **ESC key** twice to return to the 

≡CONFIGURE
▶SENSOR

 screen.

---

**7.3 SET °C OR °F (temperature display format)**

The MEASURE screen can be set to display temperature values in °C or °F. In either case, the display resolution for measured temperature is always “XX.X.”

- With the 

≡CONFIGURE
▶SENSOR

 screen displayed, press **↑ key** — not **↓ key** — twice to display 

≡CONFIGURE
▶SET °C OR °F

.
- Press **ENTER key** to display a screen like 

SET °C OR °F?
( °C )

. Use **↓** and **↑** keys to select the displayed temperature units (°C or °F), and press **ENTER key** to enter it.

---

**7.4 Configuring Analog Output**

The transmitter provides an isolated 4-20 mA analog output. During normal measurement operation, the output is active but can be held at the last measured value for up to 30 minutes by using the “HOLD OUTPUT” function in the TEST/MAINT menu. (See Section 9.2 for details.) During calibration, the output is automatically held at the last measured value and, upon completion, returned to its active state.

**SET PARAMETER (representation)**

The output can be assigned to represent the SENSOR (measured conductivity, % concentration or TDS) or measured TEMPERATURE.



- With the 

≡CONFIGURE
▶SET °C OR °F

 screen displayed, press **↑ key** — not **↓ key** — twice to display 

≡CONFIGURE
▶SET OUTPUT

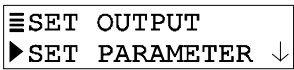
.

- Press **ENTER** key to display .
- Press **ENTER** key again to display . Use **↓** and **↑** keys to select the parameter the output will represent, and press **ENTER** key to enter it.

**SET 4mA and 20 mA VALUES (range expand)**

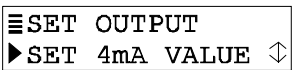
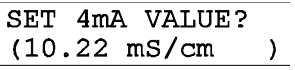
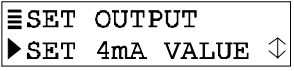
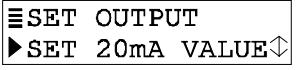
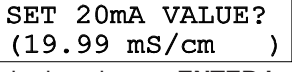

Parameter values can be set to define the endpoints at which the 4 mA and 20 mA analog output values are desired.

- With the  screen displayed, press **↓** key once to display .
- Press **ENTER** key to display a screen like . Use **arrow keys** to set the value at which 4 mA is desired, and press **ENTER** key to enter it.
- After the  screen re-appears, press **↓** key once to display .
- Press **ENTER** key to display a screen like . Use **arrow keys** to set the value at which 20 mA is desired, and press **ENTER** key to enter it.

**NOTE:** If the same values are set for 4 mA and 20 mA, the output automatically goes to and remains at 20 mA.

**SET FILTER Time**

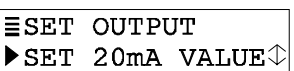
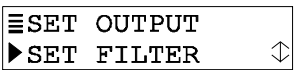
A time constant (in seconds) can be set to filter or “smooth out” the analog output signal. A minimum value of “0 seconds” has no smoothing effect. A maximum value of “60 seconds” provides maximum smoothing. Deciding what output filter time to use is a compromise. The higher the filter time, the longer the analog output signal response time will be to a change in the measured value.



- With the  screen displayed, press **↓** key once to display .
- Press **ENTER** key to display a screen like . Use **arrow keys** to adjust to a desired filter time, and press **ENTER** key to enter it.

**SET FAIL LEVEL Mode (off, 4 mA or 20 mA)**

When a “WARNING CHECK STATUS” message appears, indicating that a system problem may exist, the analog output can be set to respond in one of three ways:

- **OFF:** Output remains active.
- **4mA:** Output automatically goes to and remains at 4 mA.
- **20mA:** Output automatically goes to and remains at 20 mA.

To SET FAIL LEVEL mode to suit your application:

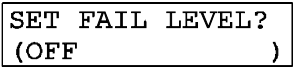
1. With the  screen displayed, press **↓ key once** to display .
2. Press **ENTER key** to display . Use **↓ and ↑ keys** to select a response mode (OFF, 4mA or 20mA), and press **ENTER key** to enter it.

**7.5 SET PASSCODE (feature enabled or disabled)**

The transmitter has a passcode feature to restrict access to configuration settings and calibration to only authorized personnel.



- **DISABLED:** With the passcode feature disabled, all configuration settings can be displayed and changed, and the transmitter can be calibrated.
- **ENABLED:** With the passcode feature enabled, all configuration settings can be displayed — but they cannot be changed — and the CALIBRATE and TEST/MAINT menus cannot be accessed without the passcode. When you attempt to change a setting in the CONFIGURE menu by pressing the **ENTER key**, a displayed notification requests passcode entry. A valid passcode entry saves the changed setting and returns the display to the “MAIN MENU” branch selection screen. An incorrect passcode entry causes the display to momentarily show an error notification before returning to the “MAIN MENU” branch selection screen. There is no limit on attempts to enter a valid passcode.

The passcode is factory set to “3 4 5 6.” It cannot be changed.

To enable or disable the passcode feature:

1. Press **MENU key** to display a “MAIN MENU” screen.

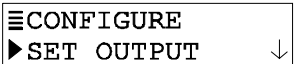
If the  screen is not showing, use **↓ and ↑ key** to display it.

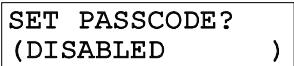
2. Press **ENTER key** to display .
3. Press **↓ key once** to display .
4. Press **ENTER key** to display . Use **↓ and ↑ keys** to select the desired passcode mode (DISABLED or ENABLED), and press **ENTER key** to enter it.

This page intentionally left blank.

**7.6 Configuration Setting Summary**

TABLE D lists all configuration settings and their entry ranges/choices and factory defaults, categorized by basic functions.

<b>TABLE D -- Transmitter Configuration Settings (Ranges/Choices and Defaults)</b>			
Displayed Screen Title	Entry Range or Choices (where applicable)	Factory Default	Your Setting
<b>LANGUAGE Setting</b>			
LANGUAGE?	ENGLISH and SPANISH (French, German, etc. may be substituted for Spanish)	ENGLISH	
<b>SENSOR Settings</b>			
SELECT MEASURE?	CONDUCTIVITY, CONCENTRATION or TDS	CONDUCTIVITY	
DISPLAY FORMAT? (full scale value)	CONDUCTIVITY: μS/cm: 200.0, or 2000 mS/cm: 2.000, 20.00, 200.0 or 2000 S/cm: 2.000 CONCENTRATION: 99.99% or 200.0% TDS: 9999 ppm	CONDUCTIVITY: 200.0 mS/cm  CONCENTRATION: 99.99% TDS: 9999 ppm	
T-COMPENSATION?	LINEAR, NATURAL WATER, TEMP TABLE or NONE	LINEAR at 2.00% per °C with 25.0°C reference temperature	
CONFIG CONC: SELECT TYPE?	BUILT-IN or USER-DEFINED	BUILT-IN	
CONFIG CONC: SET CHEMICAL?	NaOH 0-16%, CaCl <sub>2</sub> 0-22%, HNO <sub>3</sub> 0-28%, HNO <sub>3</sub> 36-96%, H <sub>2</sub> SO <sub>4</sub> 0-30%, H <sub>2</sub> SO <sub>4</sub> 40-80%, H <sub>2</sub> SO <sub>4</sub> 93-99%, H <sub>3</sub> PO <sub>4</sub> 0-40%, HCl 0-18% or HCl 23-36%	Built-in NaOH 0-16% chemical concentration table	
CONFIG CONC: USER DEFINED?	Edit default table by entering up to 10 data points with conductivity X coordinates and corresponding concentration Y coordinates	Two point default conc. table: Pt. 1: X = 0 μS/cm; Y = 0.00% Pt. 2: X = 2000 μS/cm; Y = 99.99%	
CONFIG TDS: SELECT FACTOR?	NaCl or USER DEFINED	NaCl	
CONFIG TDS: SET FACTOR?	0.01-99.99 ppm/μS	0.49 ppm/μS	
CONFIG LINEAR: SET SLOPE?	0-4.00% per °C	2.00% per °C	
CONFIG LINEAR: SET REF TEMP?	0-200.0°C or 32-392.0°F	25.0°C or 77.0°F	
CONFIG T-TABLE?	Edit default table by entering up to 10 data points with temperature X coordinates and corresponding ratio Y coordinates (0-99.99)	Two point default temp. table: Pt. 1: X = 0.0°C; Y = 1.00 Pt. 2: X = 100.0°C; Y = 1.00	
SET FILTER?	0-60 seconds	0 seconds	
ENTER NOTE?	Replace COND with up to eight characters	COND	
TEMP ELEMENT: SELECT TYPE?	PT1000 or MANUAL	PT1000	

**TABLE D -- Transmitter Configuration Settings (Ranges/Choices and Defaults) -- continued**

Displayed Screen Title	Entry Range or Choices (where applicable)	Factory Default	Your Setting
<b>SENSOR Settings (continued)</b>			
TEMP ELEMENT: SET T FACTOR?	950-1050 ohms	1000 ohms	
TEMP ELEMENT: SET MANUAL?	0.0-200.0°C	25.0°C	
<b>TEMPERATURE Display Setting</b>			
SET °C OR °F?	°C or °F	°C	
<b>OUTPUT Settings</b>			
SET PARAMETER?	SENSOR or TEMPERATURE	SENSOR	
SET 4mA VALUE?	CONDUCTIVITY: μS/cm: 0-200.0, or 0-2000 mS/cm: 0-2.000, 0-20.00, 0-200.0 or 0-2000 S/cm: 0-2.000 CONCENTRATION: 0-99.99% or 0-200.0% TDS: 0-9999 ppm TEMPERATURE: -20.0 to +200.0°C or -4.0 to 392.0°F	CONDUCTIVITY: μS/cm: 0 mS/cm: 0 S/cm: 0 CONC: 0.00% or 0.0% TDS: 0 ppm TEMPERATURE: 0.0°C or 32.0°F	
SET 20mA VALUE?	CONDUCTIVITY: μS/cm: 0-200.0 or 0-2000 mS/cm: 0-2.000, 0-20.00, 0-200.0 or 0-2000 S/cm: 0-2.000 CONCENTRATION: 0-99.99% or 0-200.0% TDS: 0-9999 ppm TEMPERATURE: -20.0 to +200.0°C or -4.0 to 392.0°F	CONDUCTIVITY: μS/cm: 200.0 or 2000 mS/cm: 2.000, 20.00, 200.0 or 2000 S/cm: 2.000 CONC: 99.99% or 200.0% TDS: 9999 ppm TEMPERATURE: 100.0°C or 212.0°F	
SET FILTER?	0-60 seconds	0 seconds	
SET FAIL LEVEL?	OFF, 4 mA or 20 mA	OFF	
<b>PASSCODE Setting</b>			
SET PASSCODE?	DISABLED or ENABLED	DISABLED	
<b>TEST/MAINT Simulation Function Settings</b>			
SELECT SIM?	SENSOR or TEMPERATURE	SENSOR	
SIM SENSOR?	CONDUCTIVITY: μS/cm: 0-200.0, or 0-2000 mS/cm: 0-2.000, 0-20.00, 0-200.0 or 0-2000 S/cm: 0-2.000 CONCENTRATION: 0-99.99% or 0-200.0% TDS: 0-9999 ppm TEMPERATURE: -20.0 to +200.0°C or -4.0 to 392.0°F	Present measured value of selected parameter	

---

## **Section 8 - Transmitter Calibration**

### **8.1 Important Information**

Each electrodeless conductivity sensor has a unique zero point and span. Consequently, **always zero the sensor when calibrating it for the first time** (Section 8.2). Zeroing provides the best possible measuring accuracy. After zeroing, calibrate for sensor span using one of the available methods, and periodically thereafter to maintain best measurement accuracy. Over time, some processes such as heavy slurries may plug the sensor hole, causing minor measurement errors. The time between calibrations, and the rate of measurement drift can vary considerably with each application and its specific conditions.

**Calibration Tip!** Establish a maintenance program to keep the sensor relatively clean and the measuring system calibrated. The weekly or monthly intervals between performing maintenance will be influenced by the characteristics of the process solution, and can only be determined by operating experience.

Since the inherent ohm value of each sensor's Pt 1000 RTD temperature element varies slightly, each element is tested to provide a unique, factory-certified temperature T FACTOR shown etched on the sensor housing. If this factor was not previously entered during configuration in Section 7.2, subheading "SET T FACTOR," **enter it now before zeroing or calibrating** to provide the best possible measuring accuracy.

**NOTE:** *When the passcode feature is enabled (Section 7.5), you must successfully enter the passcode before attempting to calibrate the transmitter.*

**An in-progress calibration can always be aborted by pressing the ESC key.** After the "ABORT: YES?" screen appears, do one of the following:

- Press **ENTER key** to abort. After the "CONFIRM ACTIVE?" screen appears, press **ENTER key** to return the analog output to its active state (MEASURE screen appears).
- Press **↑ or ↓ key** to choose "ABORT: NO?" screen, and press **ENTER key** to continue calibration.

In addition to zeroing and calibrating sensor span, the analog output loop can also be calibrated. Refer to Section 4.6 for details.

**Zeroing/Calibration Tip!** If a "CONFIRM FAILURE?" screen appears during zeroing or calibration, press **ENTER key** to confirm. Then, use **↑ or ↓ key** to select between "CAL: EXIT" or "CAL: REPEAT" and do one of the following:

- With "(CAL: EXIT)" selected, press **ENTER key**. Then, after the "CONFIRM ACTIVE?" screen appears, press **ENTER key** to return the analog output to its active state (MEASURE screen appears).
- With "(CAL: REPEAT)" selected, press **ENTER key** to repeat zeroing or calibration.



---

### 8.2 ZERO Procedure (first-time sensor calibration only)

Zero the sensor if it is being calibrated for the first time. If not, disregard this subsection and proceed with calibrating the sensor span (Section 4.3, 4.4 or 4.5).

**NOTE:** When using a new sensor, always perform a “RESET CALIBRATE” using the TEST/MAINT menu (Section 9.8) before zeroing and calibrating.

1. Make sure that the sensor is dry before zeroing.

2. Press **MENU key** to display a “MAIN MENU” screen. If the screen is not showing, use **↓** or **↑** key to display it.

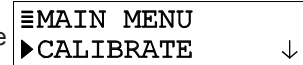

3. Press **ENTER key** to display

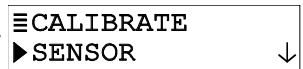

4. Press **ENTER key** again to display

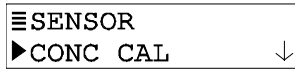
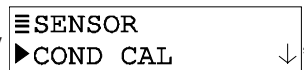

or (displayed screen depends on selected measurement).

5. Press **↓ key twice** to display

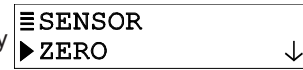

6. Press **ENTER key** to display the “ZERO: IN DRY AIR?” screen.

7. With the dry sensor held in air, press **ENTER key** again to start automatic zeroing.

**NOTE:** During zeroing, the analog output is automatically “held” at the last measured value.

8. After the “ZERO: CONFIRM ZERO OK” screen appears, press **ENTER key** to end zeroing.

9. After the “ZERO: CONFIRM ACTIVE?” screen appears, press **ENTER key** to return the analog output to its active state (MEASURE screen appears).

This completes zeroing the sensor.

---

### 8.3 Conductivity Calibration

After zeroing the sensor (first-time sensor calibration only), calibrate the sensor span using one of these methods:

- **COND CAL Method:** This method requires removing the sensor from the process, immersing it into a conductivity reference solution, and entering a reference for temperature compensation, and the known linear % per °C slope and conductivity value of the reference solution.
- **SAMPLE CAL Method:** This method allows keeping the sensor installed in the process, but requires you to obtain a process sample, determine its value by laboratory analysis or comparison reading, and enter that value.
- **ELECTRONIC CAL Method:** This method requires that the sensor be removed from the process and utilizes a decade resistance box to simulate conductivity rather than an actual solution.

**COND CAL Method**

1. Prepare the conductivity reference solution using your normal method. Its value should be near the typical measured process value for best accuracy. When the value is relatively low (between 200 and 100,000 microSiemens/cm), the data in TABLE E on the next page can be used to prepare the reference solution. Add the listed grams of pure, dried NaCl to one liter of high purity, de-ionized, CO<sub>2</sub>-free water that is 25°C to obtain the listed conductivity. Solution conductivity can be decreased by dilution with de-ionized water.

<b>TABLE E -- Conductivity Reference Solutions</b>			
Desired Solution Value			Grams NaCl To Be Added
µS/cm	mS/cm	ppm (NaCl)*	
200	0.20	100	0.10
500	0.50	250	0.25
1000	1.00	500	0.50
2000	2.00	1010	1.01
3000	3.00	1530	1.53
4000	4.00	2060	2.06
5000	5.00	2610	2.61
8000	8.00	4340	4.34
10,000	10.00	5560	5.56
20,000	20.00	11,590	11.59
50,000	50.00	31,950	31.95
100,000	100.00	72,710	72.71

\*When using ppm measuring scale for compounds other than NaCl, refer to appropriate chemistry handbook for reference solution formulation.

2. Thoroughly rinse the clean sensor in de-ionized water. Then immerse the sensor in the prepared reference solution. **Important: Allow the sensor and solution temperatures to equalize.** Depending on their temperature differences, this may take up to 30 minutes.

**NOTE:** Suspend the sensor to prevent it from touching the container. **Simply laying it into the container will produce calibration error.** If the sensor is tee-mounted, use a smaller container. Ideally, convert a tee of the same size and material as the mounting tee into a calibration container by sealing two of its ends.

3. Press **MENU** key to display a "MAIN MENU" screen.

If the 

≡MAIN MENU
▶CALIBRATE

 screen is not showing, use **↓** or **↑** key to display it.

4. Press **ENTER** key to display 

≡CALIBRATE
▶SENSOR

.

5. Press **ENTER** key again to display 

≡SENSOR
▶COND CAL

.

6. Press **ENTER** key again to display a screen like 

SET REF TEMP?
(25.0°C)

. The **default 25°C reference temperature is suitable for most applications.** For another reference, use **arrow keys** to adjust to a different temperature. In either case, press the **ENTER** key.

**NOTE:** During calibration, the analog output is automatically “held” at the last measured value.

- After a screen like 

SET SLOPE? (2.00 %/°C )
----------------------------

 appears, use **arrow keys** to adjust the slope value to match the known slope of the reference solution, and press **ENTER key** to enter the value.

**NOTE:** Measured values are normally compensated using the configured temperature compensation method. However, during calibration the measured value is linearly compensated by the entered reference temperature and slope value of the reference solution.

- With the sensor in solution and the 

COND CAL: SAMPLE READY?
----------------------------

 screen displayed, press **ENTER key** to confirm. This active

XXXX uS/cm READING STABLE?
-------------------------------

 screen appears showing the measured reference solution value.
- Wait for the reading to stabilize which may take up to 30 minutes. Then press **ENTER key**. The “PLEASE WAIT” screen may appear if the reading is still too unstable. After the reading has stabilized, this static

COND CAL? (XXXX uS/cm )
----------------------------

 screen appears showing the “last measured” value.
- Use **arrow keys** to adjust the “last-measured” value to exactly match the known value of the reference solution.
- Press **ENTER key** to enter the value and complete calibration (“CONFIRM CAL OK?” screen appears).
- Re-install the sensor into the process.
- Press **ENTER key** to display the active measurement reading on the “CONFIRM ACTIVE?” output status screen. When the reading corresponds to the actual typical process value, press **ENTER key** again to return the analog output to its active state (MEASURE screen appears).

This completes COND CAL calibration

**SAMPLE CAL Method**

The “SAMPLE CAL” method enables the sensor to remain installed in the process.

- Obtain a sample of the process solution and determine its value using laboratory analysis or a recently calibrated portable meter.
- Press **MENU key** to display a “MAIN MENU” screen. If the 

≡MAIN MENU ▶CALIBRATE
--------------------------

 screen is not showing, use **↓ or ↑ key** to display it.
- Press **ENTER key** to display 

≡CALIBRATE ▶SENSOR
-----------------------

.
- Press **ENTER key** again to display 

≡SENSOR ▶COND CAL
----------------------

.

5. Press **↓ key** once to display 

≡ SENSOR
▶ SAMPLE CAL

.
  
  6. Press **ENTER key** to display 

SAMPLE CAL:
SAMPLE READY?

. With the sensor in the process, press **ENTER key** again to confirm. This active

XXXX uS/cm
READING STABLE?

 screen appears showing the measurement reading.
- NOTE:** During calibration, the analog output is automatically “held” at the last measured value.
7. Wait for the reading to stabilize which may take up to 30 minutes. Then press **ENTER key**. The “PLEASE WAIT” screen may appear if the reading is still too unstable. After the reading has stabilized, this static

SAMPLE CAL?
(XXXX uS/cm )

 screen appears showing the “last measured” value.
  8. Use **arrow keys** to adjust the displayed value to exactly match the known value of the process sample.
  9. Press **ENTER key** to enter the value and complete calibration (“CONFIRM CAL OK?” screen appears).
  10. Press **ENTER key** again to display the active measurement reading on the “CONFIRM ACTIVE?” output status screen. When the reading corresponds to the actual typical process value, press **ENTER key** again to return the analog output to its active state (MEASURE screen appears).

This completes SAMPLE CAL calibration.

**ELECTRONIC CAL Method (only to be used after consulting with the factory)**

The “ELECTRONIC CAL” method requires that the sensor be removed from the process and utilizes a decade resistance box to simulate conductivity rather than an actual solution.

1. Determine the typical conductivity in  $\mu\text{S/cm}$  for the application.
  2. Calculate the required loop resistance by dividing 470 million by the desired conductivity in  $\mu\text{S/cm}$  (or 470 divided by the desired conductivity in  $\text{S/cm}$ )
  3. Wrap (9) nine loops of wire (18-22 AWG) around and through the center of the sensor.
  4. Connect this wire to a 1% or better decade resistance box (the decade box forms a 10th loop). Set the decade box to the value calculated above.
5. Press **MENU key** to display a “MAIN MENU” screen. If the 

≡ MAIN MENU
▶ CALIBRATE

 screen is not showing, use **↓ or ↑ key** to display it.
  
  6. Press **ENTER key** to display 

≡ CALIBRATE
▶ SENSOR

.
  
  7. Press **ENTER key** again to display 

≡ SENSOR
▶ COND CAL

.
  
  8. Press **↓ key** once to display 

≡ SENSOR
▶ SAMPLE CAL

.

9. Press **ENTER key** to display 

SAMPLE CAL : SAMPLE READY?
-------------------------------

. With the decade box connected, press **ENTER key** again to confirm. This active

XXXX uS/cm READING STABLE?
-------------------------------

 screen appears showing the measurement reading.
- NOTE:** *During calibration, the analog output is automatically “held” at the last measured value.*
10. Wait for the reading to stabilize which may take up to 30 minutes. Then press **ENTER key**. The “PLEASE WAIT” screen may appear if the reading is still too unstable. After the reading has stabilized, this static

SAMPLE CAL? (XXXX uS/cm )
------------------------------

 screen appears showing the “last measured” value.
11. Use **arrow keys** to adjust the displayed value to exactly match the desired conductivity value used in the calculation..
12. Press **ENTER key** to enter the value and complete calibration (“CONFIRM CAL OK?” screen appears).
13. Press **ENTER key** again to display the active measurement reading on the “CONFIRM ACTIVE?” output status screen. When the reading corresponds to the actual typical process value, press **ENTER key** again to return the analog output to its active state (MEASURE screen appears).

This completes ELECTRONIC CAL calibration.

### 8.4 % Concentration Calibration

After zeroing the sensor (first-time sensor calibration only), calibrate the sensor span using one of these methods:

- **CONC CAL Method:** This method requires you to immerse the sensor into a prepared % concentration reference solution of known value, or to keep the sensor installed in the process while obtaining a process sample. When keeping the sensor installed, determine the process value by laboratory analysis or comparison reading. In either case, enter the known reference solution or sample % concentration value.
  - **COND CAL Method:** This method requires removing the sensor from the process, immersing it into a conductivity reference solution, entering a reference for temperature compensation temperature, and entering the known linear % per °C slope and conductivity value of the reference solution. The conductivity reference solution should have an equivalent, uncompensated value that corresponds with the normal % concentration value of the process.
1. Depending on the situation, do one of the following:
- When Keeping Sensor Installed:  
Obtain a sample of the process solution and determine its value using laboratory analysis or a recently calibrated portable meter.
  - When Immersing Sensor in Reference Solution:  
A. Prepare a % concentration reference solution using your normal method. **To achieve accurate calibration, the reference solution must have the same chemical composition as the process.** Also, its value should be near the typical measured process value.

- B. Thoroughly rinse the clean sensor in de-ionized water. Then immerse the sensor in the prepared reference solution. **Important: Allow the sensor and solution temperatures to equalize.** Depending on their temperature differences, this may take up to 30 minutes.

**NOTE:** Suspend the sensor to prevent it from touching the container. **Simply laying it into the container will produce calibration error.** If the sensor is tee-mounted, use a smaller container. Ideally, convert a tee of the same size and material as the mounting tee into a calibration container by sealing two of its ends.

- 2. Press **MENU key** to display a “MAIN MENU” screen. If the screen is not showing, use **↓ or ↑ key** to display it.



- 3. Press **ENTER key** to display

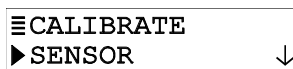

- 4. Press **ENTER key** again to display



- 5. Press **ENTER key** to display

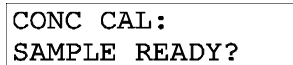

With the sensor in the process (or % concentration reference solution), press **ENTER key** again to confirm.

This active screen appears showing the measurement reading.



**NOTE:** During calibration, the analog output is automatically “held” at the last measured value.

- 6. Wait for the reading to stabilize which may take up to 30 minutes. Then press **ENTER key**. The “PLEASE WAIT” screen may appear if the reading is still too unstable. After

the reading has stabilized, this static screen appears showing the “last measured” value.

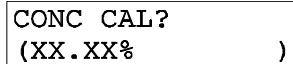

- 7. Use **arrow keys** to adjust the displayed value to exactly match the known value of the process sample (or % concentration reference solution).
- 8. Press **ENTER key** to enter the value and complete calibration (“CONFIRM CAL OK?” screen appears).
- 9. If the sensor was immersed in a reference solution, re-install the sensor into the process.
- 10. Press **ENTER key** to display the active measurement reading on the “CONFIRM ACTIVE?” output status screen. When the reading corresponds to the actual typical process value, press **ENTER key** again to return the analog output to its active state (MEASURE screen appears).

This completes CONC CAL calibration.

## 8.4 TDS Calibration

When the transmitter is set to measure % concentration but you want to calibrate using a conductivity reference solution, please refer to Section 8.3, subsection “COND CAL Method” and follow steps 1 through 13.

When the transmitter is set to measure TDS, only the “TDS CAL” method is available to calibrate sensor span. This method requires you to immerse the sensor into a properly prepared TDS reference solution of known ppm value, or to keep the sensor installed in the process while obtaining a process sample. In either case, enter the known reference solution or sample ppm value.

1. Depending on the situation, do one of the following:
  - When Keeping Sensor Installed:  
Obtain a sample of the process solution and determine its value using laboratory analysis or a recently calibrated portable meter.
  - When Immersing Sensor in Reference Solution:
    - A. Prepare a TDS reference solution using your normal method. **To achieve accurate calibration, the reference solution must have the same chemical composition as the process.** Also, its value should be near the typical measured process value. When the value is between 100 and 72,710 ppm NaCl, the data in step 1 and TABLE E of Section 4.3, subsection “COND CAL Method” can be used to prepare the reference solution.
    - B. Thoroughly rinse the clean sensor in de-ionized water. Then immerse the sensor in the prepared reference solution. **Important: Allow the sensor and solution temperatures to equalize.** Depending on their temperature differences, this may take up to 30 minutes.

**NOTE:** Suspend the sensor to prevent it from touching the container. **Simply laying it into the container will produce calibration error.** If the sensor is tee-mounted, use a smaller container. Ideally, convert a tee of the same size and material as the mounting tee into a calibration container by sealing two of its ends.

2. Press **MENU key** to display a “MAIN MENU” screen. If the screen is not showing, use **↓** or **↑** key to display it.
 

≡ MAIN MENU  
 ▶ CALIBRATE    ↓
3. Press **ENTER key** to display
 

≡ CALIBRATE  
 ▶ SENSOR    ↓
4. Press **ENTER key** again to display
 

≡ SENSOR  
 ▶ TDS CAL    ↓
5. Press **ENTER key** to display
 

TDS CAL :  
 SAMPLE READY?

 . With the sensor in the process (or reference solution), press **ENTER key** again to confirm. This active

XXXX ppm  
 READING STABLE?

 screen appears showing the measurement reading.

**NOTE:** During calibration, the analog output is automatically “held” at the last measured value.

6. Wait for the reading to stabilize which may take up to 30 minutes. Then press **ENTER key**. The “PLEASE WAIT” screen may appear if the reading is still too unstable. After

the reading has stabilized, this static

TDS CAL? (XXXX ppm )
-------------------------

 screen appears showing the “last measured” value.

7. Use **arrow keys** to adjust the displayed value to exactly match the known value of the process sample (or TDS reference solution).
8. Press **ENTER key** to enter the value and complete calibration (“CONFIRM CAL OK?” screen appears).
9. If the sensor was immersed in a reference solution, re-install the sensor into the process.
10. Press **ENTER key** again to display the active measurement reading on the “CONFIRM ACTIVE?” output status screen. When the reading corresponds to the actual typical process value, press **ENTER key** again to return the analog output to its active state (MEASURE screen appears).

This completes TDS CAL calibration.



### 8.6 Analog Output Calibration

The transmitter analog output is factory-calibrated. However, it can be re-calibrated if desired.

**NOTE:** When the passcode feature is enabled (Section 7.5), you must successfully enter the passcode before attempting to calibrate the analog output. Also, the transmitter adjustment range for output values during calibration is  $\pm 2$  mA.

1. Press **MENU key** to display a “MAIN MENU” screen. If the screen is not showing, use **↓** or **↑** key to display it.
 

≡MAIN MENU  
 ▶CALIBRATE ↓
2. Press **ENTER key** to display
 

≡CALIBRATE  
 ▶SENSOR ↓
3. Press **↓ key once** to display
 

≡CALIBRATE  
 ▶CAL OUTPUT ↕
4. Press **ENTER key** to display
 

≡CAL OUTPUT  
 ▶CAL OUT 4mA ↓
5. Press **ENTER key** again to display a screen like
 

CAL OUT 4mA?  
 (XXX )

 . The displayed value is “counts” — not mA — that dynamically change as the output is adjusted.
6. Connect a calibrated digital multimeter in series with the loop load to measure the actual minimum mA output in the loop.
7. Use **arrow keys** to adjust the minimum output value to read exactly “4.00 mA” on the digital multimeter — not the transmitter display, and press **ENTER key** to complete calibration of the minimum endpoint value.
8. After the screen re-appears, press **↓ key once** to display .
9. Press **ENTER key** to display a screen like . Once again the displayed value is “counts” — not mA — that dynamically change as the output is adjusted.
10. Now measure the actual maximum mA output in the loop with the digital multimeter.
11. Use **arrow keys** to adjust the maximum output value to read exactly “20.00 mA” on the digital multimeter — not the transmitter display, and press **ENTER key** to complete calibration of the maximum endpoint value.

This completes analog output calibration.

---

## Section 9 - Testing & Maintenance

The transmitter has TEST/MAINT menu screens to:



- Check operating status of the transmitter and sensor.
- Hold analog output at its last measured value.
- Provide analog output test signal to confirm operation of connected device.
- Identify transmitter firmware EPROM version.
- Simulate a measurement or temperature signal to exercise the measurement loop.
- Reset configuration — not calibration — values to defaults.
- Reset calibration — not configuration — values to defaults.

**NOTE:** When the passcode feature is enabled (Section 7.5), you must successfully enter the passcode before attempting to use the TEST/MAINT menu screens.

---



### 9.1 STATUS Check (transmitter and sensor)

The system diagnostic capabilities of the transmitter enable you to check the operating status of the transmitter and sensor. The MEASURE screen will flash the “WARNING CHECK STATUS” message when a system diagnostic “fail” condition has been detected. To determine the condition causing the warning, display the “STATUS” screens.

1. Press **MENU key** to display a “MAIN MENU” screen. If the screen is not showing, use **↓** or **↑** key to display it. 
2. Press **ENTER key** to display .
3. Press **ENTER key** again to display “STATUS: ANALYZER OK” screen. This screen confirms that the transmitter is operating properly. If “FAIL” appears, it may mean:
  - Analog-to-digital converter not responding.
  - Internal serial communications failure.
4. Press **ENTER key** once to view “STATUS: SENSOR OK” screen. If “FAIL” appears, it indicates that the sensor cable wires or terminals are shorted.
5. Press **ENTER key** once to view the “STATUS: TEMP OK” screen. If “FAIL” appears, it indicates that the PT1000 RTD temperature element in the sensor is inoperative, disconnected or incorrectly wired.
6. To end status checking, press **ESC key** or **ENTER key** (display returns to previous level of TEST/MAINT menu branch).

### 9.2 HOLD OUTPUT

The HOLD OUTPUT function conveniently holds the analog output at its last measured value for up to 30 minutes to suspend operation of any connected device.



1. With the  screen displayed, press **↓** key once to display  screen.
2. Press **ENTER** key to immediately hold the analog output (“HOLD OUTPUT: ENTER TO RELEASE” screen appears, acknowledging hold is applied).

**NOTE:** *If the keypad is not used within 30 minutes, the analog output will automatically change back to its active state and the display will return to the MEASURE screen.*

3. To release the hold at any time and return the analog output back to its “active” state, press **ENTER** key (display returns to previous level of TEST/MAINT menu branch).

### 9.3 OUTPUT Test Signal

The OUTPUT function provides an analog output test signal of a desired mA value to confirm operation of a connected device.

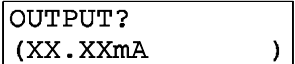

1. With the  screen displayed, press **↓** key until  screen appears.
2. Press **ENTER** key to display a screen like .

**NOTE:** The mA output test signal is now active. Its value is shown on this screen.

3. Use **arrow keys** to adjust the displayed value to obtain the desired mA test signal.
4. To remove the output test signal and return to the previous level of the TEST/MAINT menu branch, press **ESC** key or **ENTER** key.

### 9.4 Firmware (EPROM VERSION) Check

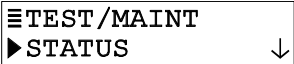
The EPROM VERSION function checks the version of firmware used in the transmitter.

1. With the  screen displayed, press **↓** key until  screen appears.
2. Press **ENTER** key to view the EPROM version screen.
3. To return to the previous level of the TEST/MAINT menu branch, press **ESC** key or **ENTER** key.

**9.5 SELECT SIM Measurement**

The SELECT SIM function selects a type of simulated measurement. It is used in conjunction with the SIM SENSOR function (Section 9.6) to simulate a measured value, making the analog output respond accordingly.

1. With the 

≡TEST/MAINT
▶STATUS

 screen displayed, press **↓ key** until 

≡TEST/MAINT
▶SELECT SIM

 screen appears.
2. Press **ENTER key** to display a screen like 

SELECT SIM?
(SENSOR )

. Use **↓ and ↑ keys** to select the type of simulated measurement, and press **ENTER key** to enter it:
  - **SENSOR:** Selects simulated measurement to be the configured measurement (conductivity, % concentration or TDS).
  - **TEMPERATURE:** Selects simulated measurement to be temperature.

**9.6 SIM SENSOR Setting**

After selecting the type of simulated measurement (Section 9.5), use the SIM SENSOR function to set the desired simulation value.

1. With the 

≡TEST/MAINT
▶SELECT SIM

 screen displayed, press **↓ key once** to display 

≡TEST/MAINT
▶SIM SENSOR

.
2. Press **ENTER key** to display a screen like 

SIM SENSOR?
(XXXX mS/cm )

.

**NOTE:** The analog output signal is now active. It has a mA value that corresponds to the measurement value shown on this screen.



3. Use **arrow keys** to adjust the displayed simulation value to the desired value.
4. To remove the simulated output and return to the previous level of the TEST/MAINT menu branch, press **ESC key** or **ENTER key**.

---

### 9.7 RESET CONFIGURE Values to Factory Defaults

The RESET CONFIGURE function resets stored configuration settings (all at the same time) — **but not calibration settings** — to their factory-set defaults shown in TABLE D.



**NOTE:** Resetting configuration values *also excludes* the SELECT MEASURE function (conductivity, % concentration or TDS) which remains as is until you change it.

1. With the  screen displayed, press **↓** key until  screen appears..
2. Press **ENTER** key to display the “RESET CONFIGURE: ARE YOU SURE?” screen, asking if you really intend to perform this extreme action. (To abort this procedure, press **ESC** key now.)
3. Press **ENTER** key to reset stored configuration settings — **not calibration settings** — to factory defaults. The “RESET CONFIGURE: DONE” screen appears, acknowledging that reset has occurred.
4. To return to the previous level of the TEST/MAINT menu branch, press **ESC** key or **ENTER** key.

---

### 9.8 RESET CALIBRATE Values to Factory Defaults

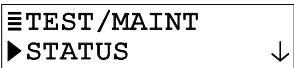
The RESET CALIBRATE function resets all stored calibration settings — **but not configuration settings** — to factory-set defaults.

1. With the  screen displayed, press **↓** key until  screen appears.
2. Press **ENTER** key to display the “RESET CALIBRATE: ARE YOU SURE?” screen, asking if you really intend to perform this extreme action. (To abort this procedure, press **ESC** key now.)
3. Press **ENTER** key to reset all stored calibration settings — **not configuration settings** — to factory defaults. The “RESET CALIBRATE: DONE” screen appears, acknowledging that reset has occurred.
4. To return to the previous level of the TEST/MAINT menu branch, press **ESC** key or **ENTER** key.

---

## **Section 10 - Troubleshooting**

---

### **10.1 Keeping the Transmitter Calibrated**

Depending on application circumstances, periodically calibrate the transmitter to maintain measurement accuracy.

**Maintenance Tip!** Upon startup, frequently check the system until operating experience can determine the optimum time between calibrations that provides acceptable measurement results.

Calibrate the transmitter using a method described in Section 8.3, 8.4 or 8.5. Calibrating with old, contaminated or diluted reference solution may cause measurement errors. **Do not reuse reference solutions.** Note that the value of a reference solution changes as its temperature changes. Therefore, always allow the temperatures of the sensor and reference solution to equalize while calibrating.

---

### **10.2 Avoiding Electrical Interference**

**Recommendation:** Do not run sensor cable (and interconnect cable, if used) in same conduit with AC or DC power.

**Maintenance Tip!** Excess cable should not be coiled near motors or other equipment that may generate electrical or magnetic fields. Cut cables to proper length during installation to avoid unnecessary inductive pickup ("electrical noise" may interfere with the sensor signal).

When experiencing problems, try to determine the primary measurement system component causing the problem (sensor, transmitter or interconnect cable, if used).

---

### **10.3 Checking Electrical Connections**

1. Verify that adequate DC voltage exists at the appropriate transmitter TB1 terminals.
2. Check all transmitter wiring to ensure proper connections.

---

### **10.4 Verifying Sensor Operation**

To verify sensor operation, refer to the procedure in the troubleshooting section of the sensor operating manual. Or replace the suspect sensor with a known new or working sensor and perform calibration.

---

### **10.5 Verifying Transmitter Operation**

1. After disconnecting DC power and the sensor from the transmitter, connect a 1000 ohm resistor between Terminals 4 (red) and 5 (yellow) on TB2.
2. Connect a 100,000 ohm resistor between Terminals 1 (white) and 7 (green) on TB2.
3. Reconnect DC power to the transmitter.
4. Verify that the transmitter conductivity reading is between 5.00 and 50.00 mS/cm. Also, verify that the temperature reading is between -10 and +10°C.

If these readings are achieved, the transmitter is operating properly, but the interconnect cable (if used) may be faulty.

**10.6 Verifying Interconnect Cable Integrity**

1. Disconnect DC power from the transmitter. Reconnect the sensor directly to the transmitter (purposely bypassing the interconnect cable and junction box, if used).
2. Place the sensor in a container of saturated salt water that is at room temperature.
3. Reconnect DC power to the transmitter.
4. Verify that the transmitter conductivity reading is between 150 and 350 mS/cm. If the reading is achieved, the interconnect cable and/or junction box connections are probably faulty. Use a digital multimeter to check the interconnect cable for shorted or open wires.

---

**Section 11 - Ordering Matrix**

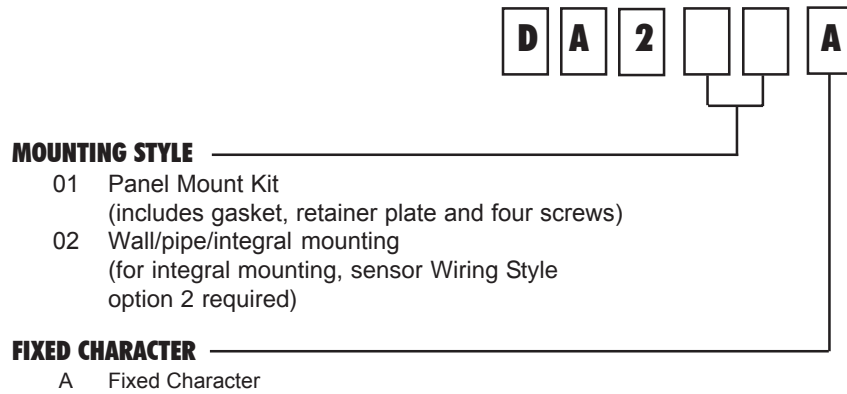

---

## **Section 12 - Warranty and Return Statement**

These products are sold by The Anderson Instrument Company (Anderson) under the warranties set forth in the following paragraphs. Such warranties are extended only with respect to a purchase of these products, as new merchandise, directly from Anderson or from an Anderson distributor, representative or reseller, and are extended only to the first buyer thereof who purchases them other than for the purpose of resale.

### ***Warranty***

These products are warranted to be free from functional defects in materials and workmanship at the time the products leave the Anderson factory and to conform at that time to the specifications set forth in the relevant Anderson instruction manual or manuals, sheet or sheets, for such products for a period of one year.

**THERE ARE NO EXPRESSED OR IMPLIED WARRANTIES WHICH EXTEND BEYOND THE WARRANTIES HEREIN AND ABOVE SET FORTH. ANDERSON MAKES NO WARRANTY OF MERCHANTABILITY OR FITNESS FOR A PARTICULAR PURPOSE WITH RESPECT TO THE PRODUCTS.**

### ***Limitations***

Anderson shall not be liable for any incidental damages, consequential damages, special damages, or any other damages, costs or expenses excepting only the cost or expense of repair or replacement as described above.

Products must be installed and maintained in accordance with Anderson instructions. Users are responsible for the suitability of the products to their application. There is no warranty against damage resulting from corrosion, misapplication, improper specifications or other operating condition beyond our control. Claims against carriers for damage in transit must be filed by the buyer.

This warranty is void if the purchaser uses non-factory approved replacement parts and supplies or if the purchaser attempts to repair the product themselves or through a third party without Anderson authorization.

### ***Returns***

Anderson's sole and exclusive obligation and buyer's sole and exclusive remedy under the above warranty is limited to repairing or replacing (at Anderson's option), free of charge, the products which are reported in writing to Anderson at its main office indicated below.

Anderson is to be advised of return requests during normal business hours and such returns are to include a statement of the observed deficiency. The buyer shall pre-pay shipping charges for products returned and Anderson or its representative shall pay for the return of the products to the buyer.

Approved returns should be sent to:      ANDERSON INSTRUMENT COMPANY INC.  
156 AURIESVILLE ROAD  
FULTONVILLE, NY 12072 USA

ATT: REPAIR DEPARTMENT