

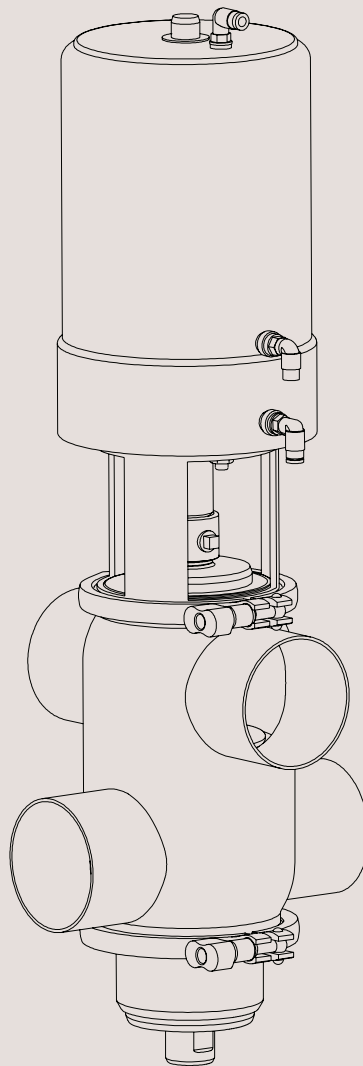

Spare Parts

Unique PMO Plus[®] Mixproof Sanitary Valve



TD 449-359

ESE00713ENUS 0901

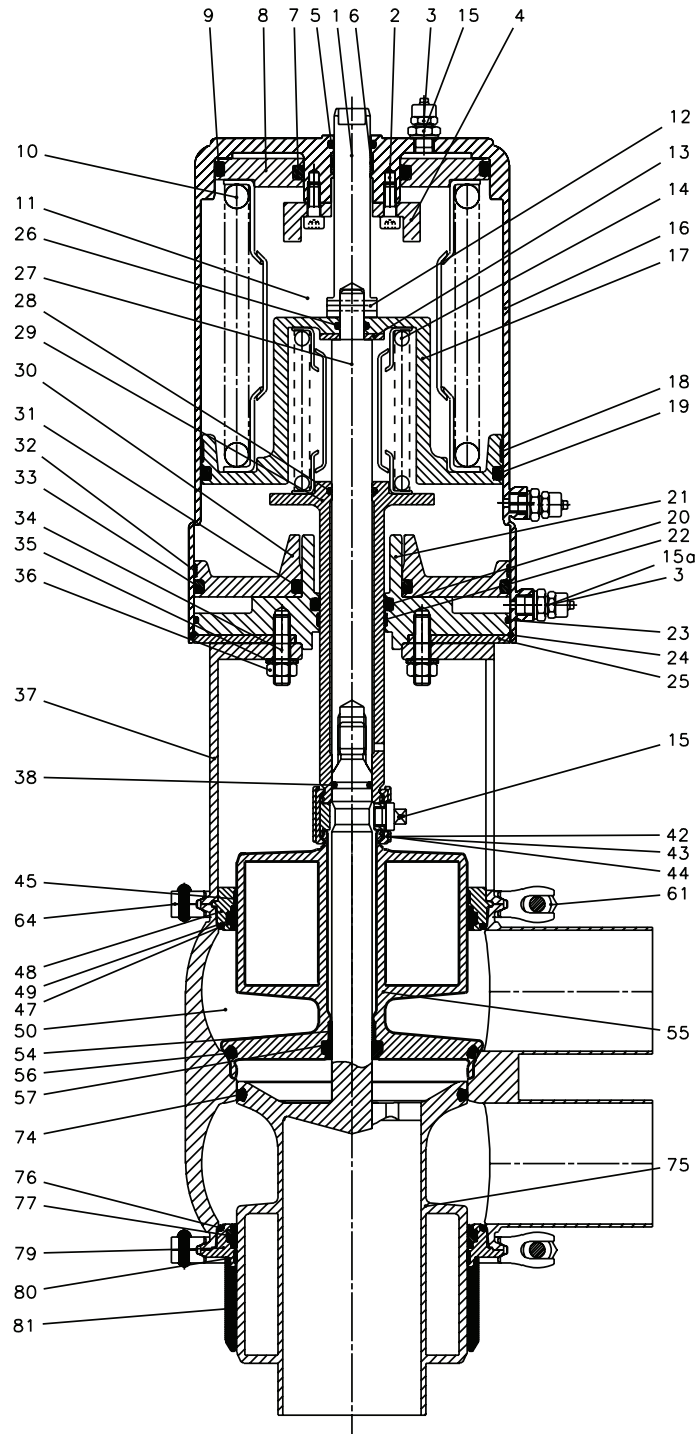

TD 449-360

Wear Parts

Pos.	Qty.	Denomination	PMO 2"	PMO 2½" PMO 3"	PMO 4"
			Seat ø81.3	Seat ø115.3	Seat ø143.9
38	1	O-ring, EPDM.....	9611-99-3555	9611-99-3572	9611-99-3572
47	1	O-ring, NBR (Standard).....	9611-99-3637	9611-99-3641	9611-99-3645
	1	O-ring, EPDM.....	9611-99-3636	9611-99-3640	9611-99-3644
	1	O-ring, HNBR.....	9611-99-3639	9611-99-3643	9611-99-3647
	1	O-ring, FPM.....	9611-99-3638	9611-99-3642	9611-99-3646
49	1	Lip seal, NBR (Standard).....	9613-0085-46	9613-0085-47	9613-0085-37
	1	Lip seal, EPDM.....	9613-0085-26	9613-0085-31	9613-0085-36
	1	Lip seal, HNBR.....	9613-0085-29	9613-0085-34	9613-0085-39
	1	Lip seal, FPM.....	9613-0085-28	9613-0085-33	9613-0085-38
56	1	Seal ring, NBR (Standard).....	9613-0951-15	9613-0951-16	9613-0951-24
	1	Seal ring, EPDM.....	9613-0953-09	9613-0953-12	9613-0953-19
	1	Seal ring, HNBR.....	9613-0953-08	9613-0953-11	9613-0953-18
	1	Seal ring, FPM.....	9613-0951-08	9613-0951-11	9613-0951-22
57	1	Lip seal, NBR (Standard).....	9613-0087-18	9613-0087-18	9613-0087-18
	1	Lip seal, EPDM.....	9613-0087-11	9613-0087-11	9613-0087-11
	1	Lip seal, HNBR.....	9613-0087-14	9613-0087-14	9613-0087-14
	1	Lip seal, FPM.....	9613-0087-13	9613-0087-13	9613-0087-13
74	1	Seal ring, NBR (Standard).....	9613-0952-15	9613-0952-16	9613-0952-24
	1	Seal ring, EPDM.....	9613-0089-09	9613-0089-12	9613-0089-18
	1	Seal ring, HNBR.....	9613-0089-08	9613-0089-11	9613-0089-17
	1	Seal ring, FPM.....	9613-0952-08	9613-0952-11	9613-0952-22
76	1	O-ring, NBR (Standard).....	9611-99-3637	9611-99-3641	9611-99-3645
	1	O-ring, EPDM.....	9611-99-3636	9611-99-3640	9611-99-3644
	1	O-ring, HNBR.....	9611-99-3639	9611-99-3643	9611-99-3647
	1	O-ring, FPM.....	9611-99-3638	9611-99-3642	9611-99-3646
77	1	Lip seal, NBR (Standard).....	9613-0085-46	9613-0085-47	9613-0085-37
	1	Lip seal, EPDM.....	9613-0085-26	9613-0085-31	9613-0085-36
	1	Lip seal, HNBR.....	9613-0085-29	9613-0085-34	9613-0085-39
	1	Lip seal, FPM.....	9613-0085-28	9613-0085-33	9613-0085-38

Parts

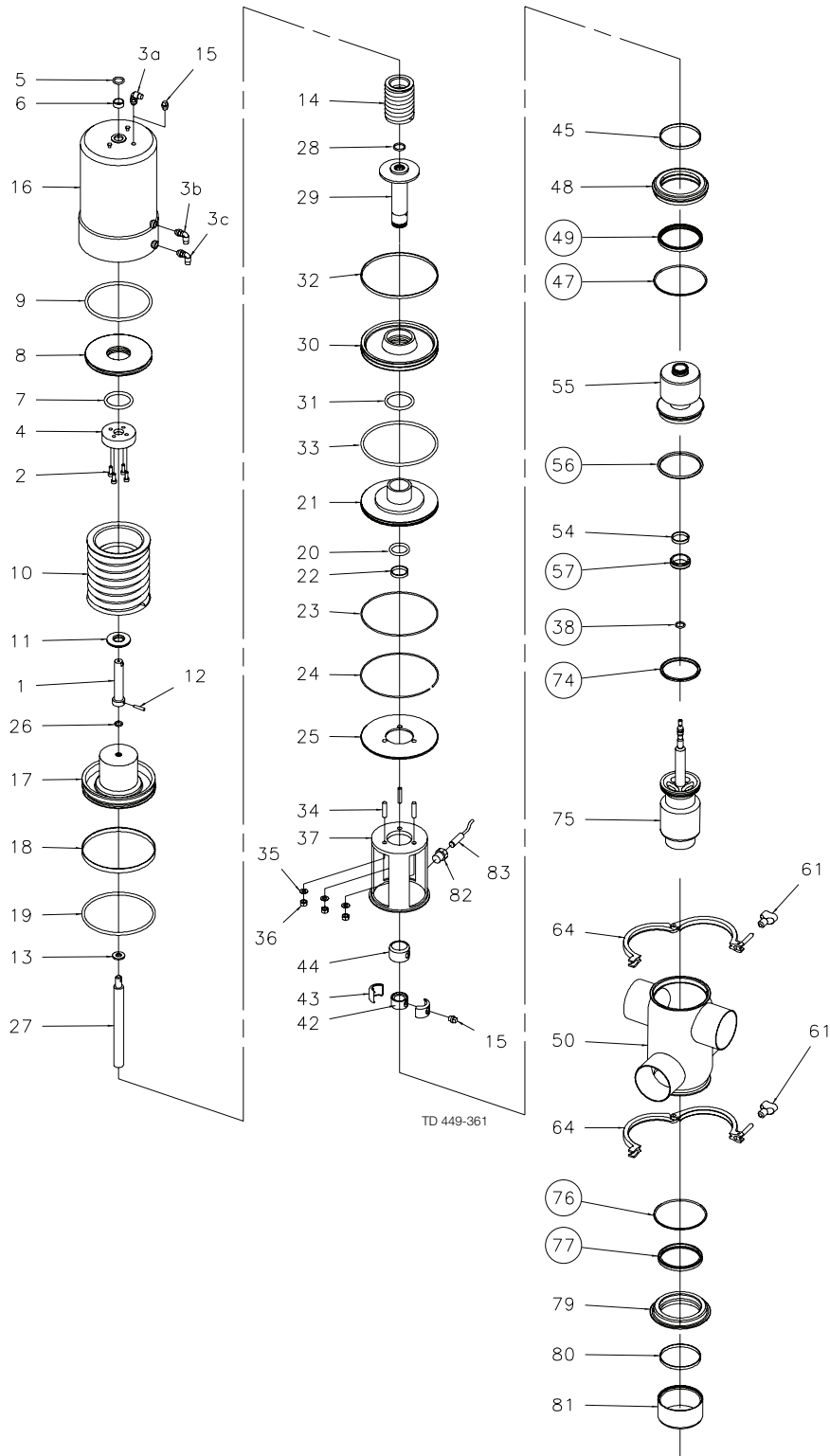

Parts

Pos.	Qty.	Denomination	PMO 2" Seat ø81.3	PMO 2½" Seat ø115.3	PMO 3" Seat ø115.3	PMO 4" Seat ø143.9
	1	Complete actuator.....	9613-0554-68	9613-0995-09	9613-0995-09	9613-0837-69
1	1	Upper stem.....	9613-0101-02	9613-0074-01	9613-0074-01	9613-0074-02
2	4	Screw.....		9611-99-3342	9611-99-3342	9611-99-3342
3	1	Air fitting yellow.....	9611-99-4171	9611-99-4171	9611-99-4171	9611-99-4171
	1	Air fitting blue.....	9611-99-3780	9611-99-3780	9611-99-3780	9611-99-3780
	1	Air fitting red.....	9611-99-4172	9611-99-4172	9611-99-4172	9611-99-4172
4	1	Stop for upper piston.....		9613-0053-01	9613-0053-01	9613-0053-02
5	1	O-ring, NBR.....	9611-99-3499	9611-99-3499	9611-99-3499	9611-99-3499
6	1	Guide ring, Turcite.....	9613-0084-08	9613-0084-08	9613-0084-08	9613-0084-08
7	1	O-ring, NBR.....		9611-99-3514	9611-99-3514	9611-99-3514
8	1	Upper piston.....		9613-0056-01	9613-0056-01	9613-0056-02
9	1	O-ring, NBR.....		9611-99-3512	9611-99-3512	9611-99-3513
10	1	Spring assembly.....	9613-0125-01	9613-0075-01	9613-0075-01	9613-0256-03
11	1	Distance spacer.....	9613-0102-02			
12	1	Pin.....	9611-99-4197	9611-99-4198	9611-99-4198	9611-99-4199
13	1	Washer.....	9611-99-3594	9611-99-3595	9611-99-3595	9611-99-3596
14	1	Spring assembly.....	9613-0131-02	9613-0095-02	9613-0095-02	9613-0095-02
15	1	Plug.....	9613-4141-01	9613-4141-01	9613-4141-01	9613-4141-01
16	1	Cylinder (3A marking).....	9613-0126-06	9613-0051-06	9613-0051-06	9613-0150-11
17	1	Main piston.....	9613-0132-01	9613-0057-01	9613-0057-01	9613-0159-01
18	1	Guide ring, Turcite.....	9613-0084-09	9613-0084-10	9613-0084-10	9613-0084-11
19	1	O-ring, NBR.....	9611-99-3505	9611-99-3507	9611-99-3507	9611-99-3509
20	1	O-ring, NBR.....	9611-99-3503	9611-99-3607	9611-99-3607	9611-99-3607
21	1	Bottom.....	9613-0140-01	9613-0054-01	9613-0054-01	9613-0168-01
22	1	Guide ring, Turcite.....	9613-0084-03	9613-0084-04	9613-0084-04	9613-0084-04
23	1	O-ring, NBR.....	9611-99-2228	9611-99-1489	9611-99-1489	22340675
24	1	Retaining ring.....	9613-0248-02	9613-0248-03	9613-0248-03	9613-0248-04
25	1	Cover disk.....	9613-0058-02	9613-0058-03	9613-0058-03	9613-0058-04
26	1	O-ring, NBR.....	9611-99-3528	9611-99-3495	9611-99-3495	9611-99-3530
27	1	Inner stem.....	9613-0106-03	9613-0073-03	9613-0073-03	9613-0073-02
28	1	O-ring.....	9611-99-3495	9611-99-0030	9611-99-0030	9611-99-0030
29	1	Piston rod.....	9613-0134-02	9613-0060-02	9613-0060-02	9613-0060-02
30	1	Lower piston.....	9613-0138-01	9613-0055-01	9613-0055-01	9613-0166-01
31	1	O-ring, NBR.....	42153	42153	42153	42153
32	1	Guide ring, Turcite.....	9613-0084-05	9613-0084-06	9613-0084-06	9613-0084-07
33	1	O-ring, NBR.....	22341275	9611-99-3508	9611-99-3508	9611-99-3510
34	3	Bolt.....	9611-99-3618	9611-99-3618	9611-99-3618	9611-99-3618
35	3	Washer.....	9611-99-3594	9611-99-3594	9611-99-3594	9611-99-3594
36	3	Nut.....	9611-99-0360	9611-99-0360	9611-99-0360	9611-99-0360
42	1	Spindle liner.....	9613-0335-01	9613-0090-01	9613-0090-01	9613-0090-01
43	2	Clamp.....	9613-0336-01	9613-0092-01	9613-0092-01	9613-0092-01
44	1	Lock.....	9613-0091-02	9613-0091-01	9613-0091-01	9613-0091-01
45	1	Guide ring, PTFE.....	9613-0084-14	9613-0084-15	9613-0084-15	9613-0084-21
48	1	Upper sealing element.....	9613-0064-04	9613-0188-04	9613-0188-04	9613-0713-01
54	1	Guide ring, PTFE.....	9613-0084-02	9613-0084-02	9613-0084-02	9613-0084-02
55	1	Upper plug.....	9613-4586-01	9613-4587-01	9613-4587-03	9613-4588-01
61	2	Wingnut.....	9612-5580-01	9612-5580-01	9612-5580-01	9612-5580-01
64	2	Clamp without nut.....	9613-0216-01	9613-0217-01	9613-0217-01	9613-0218-01
75	1	Lower plug.....	9613-0705-01	9613-0706-01	9613-0707-01	9613-0708-01
79	1	Lower sealing element.....	9613-0241-04	9613-0243-04	9613-0243-04	9613-0715-01
80	1	Guide ring, PTFE.....	9613-0084-14	9613-0084-15	9613-0084-15	9613-0084-21
81	1	Cover.....	9613-0490-06	9613-0490-07	9613-0490-07	9613-0490-16
82	1	Bolt for indication.....	9613-0926-02	9613-0926-01	9613-0926-01	9613-0926-01
83	1	Sensor for indication.....	9611-99-4541	9611-99-4541	9611-99-4541	9611-99-4541
84	1	Plate for sensor for indication.....	9613-0957-01	9613-0957-01	9613-0957-01	9613-0957-01

Parts

Pos.	Qty.	Denomination	PMO 2" Seat ø81.3	PMO 2½" Seat ø115.3	PMO 3" Seat ø115.3	PMO 4" Seat ø143.9
37	1	Intermediate piece.....	9613-0191-21	9613-0192-15	9613-0192-13	9613-0193-17
50	1	Valve body 11-00.....	9613-0709-01	9613-0710-01	9613-0711-01	9613-0712-01
	1	Valve body 12-00.....	9613-0709-05	9613-0710-05	9613-0711-05	9613-0712-05
	1	Valve body 21-00.....	9613-0709-07	9613-0710-07	9613-0711-07	9613-0712-07
	1	Valve body 22-00.....	9613-0709-09	9613-0710-09	9613-0711-09	9613-0712-09
	1	Valve body 11-90.....	9613-0709-02	9613-0710-02	9613-0711-02	9613-0712-02
	1	Valve body 12-90.....	9613-0709-06	9613-0710-06	9613-0711-06	9613-0712-06
	1	Valve body 21-90.....	9613-0709-08	9613-0710-08	9613-0711-08	9613-0712-08
	1	Valve body 22-90.....	9613-0709-10	9613-0710-10	9613-0711-10	9613-0712-10
	1	Valve body 11-180.....	9613-0709-03	9613-0710-03	9613-0711-03	9613-0712-03
	1	Valve body 11-270.....	9613-0709-04	9613-0710-04	9613-0711-04	9613-0712-04

900-547

TYPE 11-00

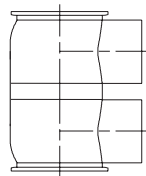

TYPE 11-90

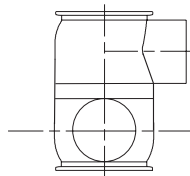

TYPE 11-180

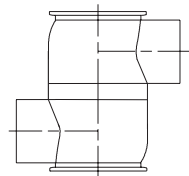

TYPE 11-270

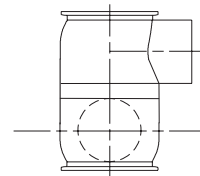

TYPE 12-00

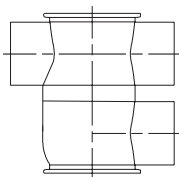

TYPE 12-90

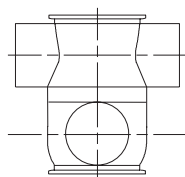

TYPE 21-00

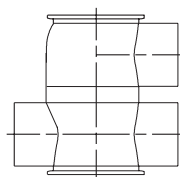

TYPE 21-90

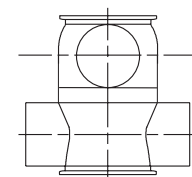

TYPE 22-00

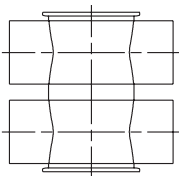

TYPE 22-90

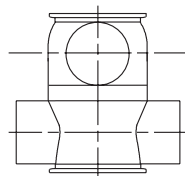

TD 449-014,1

Service kits for Product Wetted Parts

Denomination

PMO 2"

Service kit, NBR.....	9611-92-6016
Service kit, EPDM.....	9611-92-6013
Service kit, HNBR.....	9611-92-6022
Service kit, FPM.....	9611-92-6019

PMO 2.5"+3"

Service kit, NBR.....	9611-92-6017
Service kit, EPDM.....	9611-92-6014
Service kit, HNBR.....	9611-92-6023
Service kit, FPM.....	9611-92-6020

PMO 4"

Service kit, NBR.....	9611-92-6018
Service kit, EPDM.....	9611-92-6015
Service kit, HNBR.....	9611-92-6024
Service kit, FPM.....	9611-92-6021

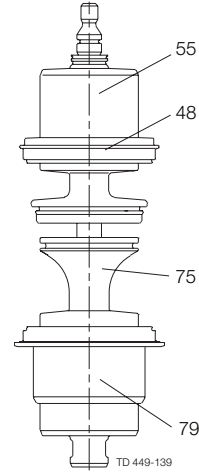

(Plug set-up 12)

900-547

Rebuilding Set PMO Plus[®] to PMO Plus[®] CP

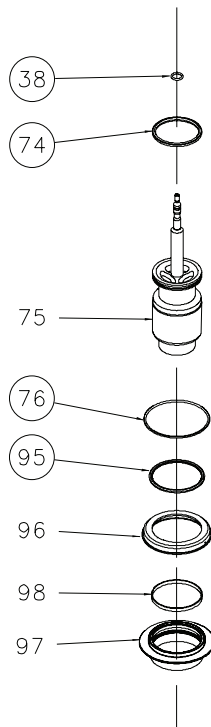

TD 449-362

Rebuilding Set PMO Plus® to PMO Plus® CP

	PMO 2" Seat ø81.3	PMO 2½" Seat ø115.3	PMO 3" Seat ø115.3	PMO 4" Seat ø143.9
Lower plug, cpl., NBR.....	9613-4662-17	9613-4662-18	9613-4662-19	9613-4662-20
Lower plug, cpl., EPDM.....	9613-4662-21	9613-4662-22	9613-4662-23	9613-4662-24
Lower plug, cpl., HNBR.....	9613-4662-25	9613-4662-26	9613-4662-27	9613-4662-28
Lower plug, cpl., FPM.....	9613-4662-29	9613-4662-30	9613-4662-31	9613-4662-32

Pos.	Qty.	Denomination
38	1	O-ring
74	1	Seal ring
75	1	Lower plug
76	1	O-ring
95	1	Special lip seal
96	1	Lower sealing element, upper part
97	1	Lower sealing element, lower part
98	1	Guide ring

Axial Installation Tool

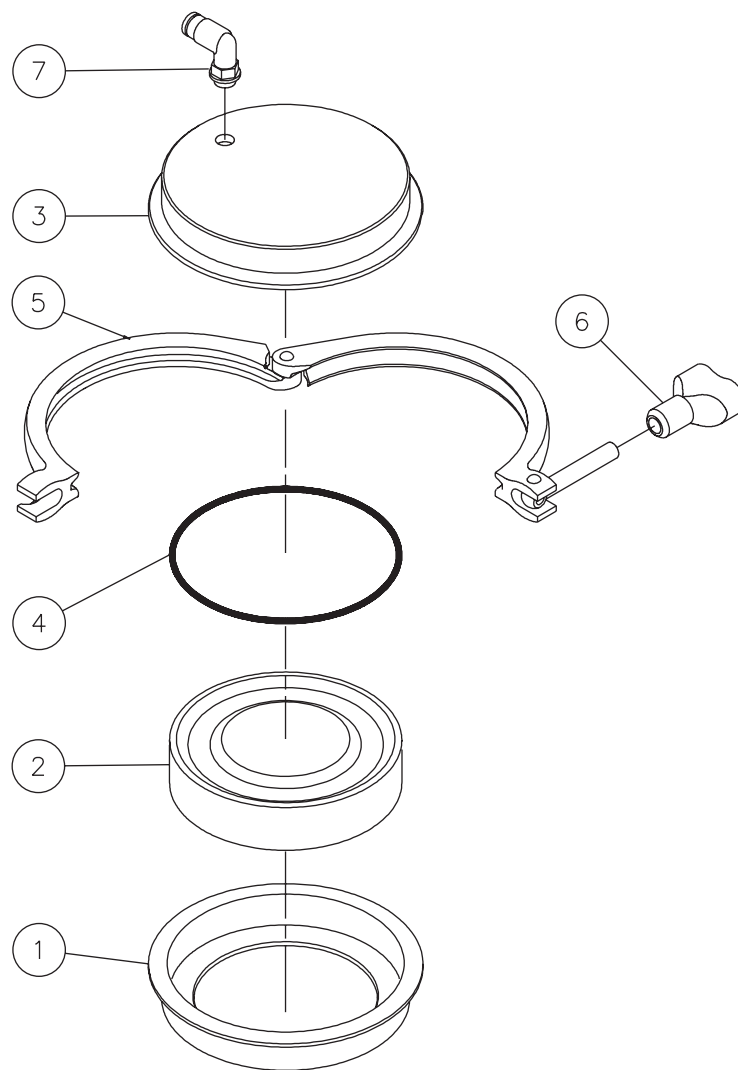

TD 449-038

Axial Installation Tool

Pos.	Qty.	Denomination	Seat ø81.3	Seat ø115.3	Seat ø143.9
			9613-0505-02	9613-0505-03	9613-0505-07
1	1	Lower part.....			
2	1	Piston.....			
3	1	Upper part.....			
4	1	O-ring, NBR.....	9611-99-3703	9611-99-3349	9611-99-4113
5	1	Clamp.....			
6	1	Wingnut.....			
7	1	Air fitting.....			

TD900198

Radial Installation Tool

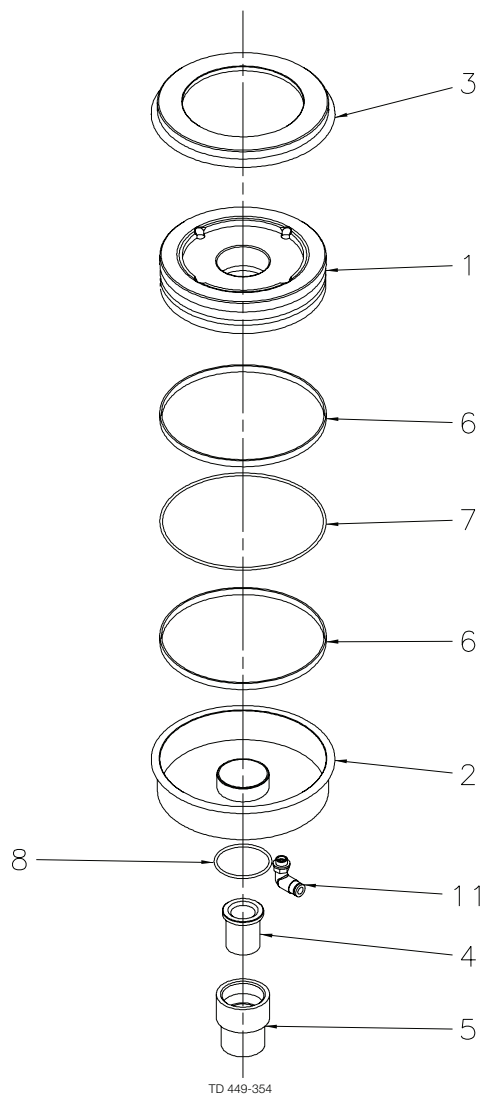

Radial Installation Tool

Pos.	Qty.	Denomination	Seat ø81.3	Seat ø115.3	Seat ø143.9
			9613-4260-02	9613-4260-04	9613-4260-09
1	1	Piston.....			
2	1	Lower part.....			
3	1	Upper part.....			
4	1	Bushing.....			
5	1	Guide.....			
6	2	Guide ring.....	9613-0084-22	9613-0084-22	9613-0084-23
7	1	O-ring, NBR.....	9611-99-3349	9611-99-3349	9611-99-4113
8	1	O-ring, NBR.....	9611-99-3705	9611-99-3705	9611-99-3705
9	1	Clamp.....			
10	1	Wingnut.....			
11	1	Air fitting.....			

TD900507

How to contact Alfa Laval

Contact details for all countries are continually updated on our website. Please visit www.alfalaval.com to access the information direct.