



RODEM[®]

PROCESS EQUIPMENT

www.rodem.com 800-543-7312

Instruction Manual

ThinkTop[®] Digital 8-30 or 110 VAC NO/NC

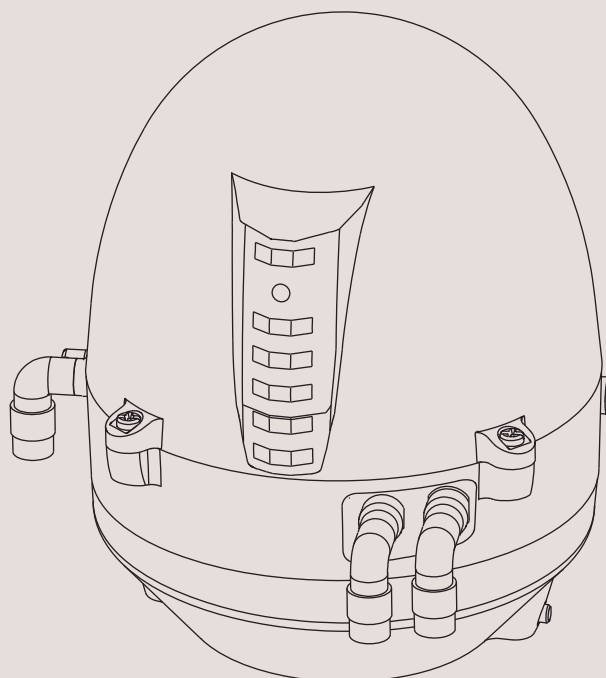

TD800100_3

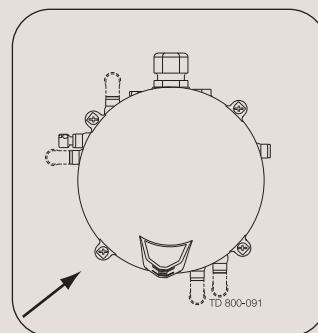

The Top is identified by 4 fastening screws

ESE00354-EN8 2013-07

Original manual

The information herein is correct at the time of issue but may be subject to change without prior notice

1. EC Declaration of Conformity	4
2. Safety	5
2.1. Important information	5
2.2. Warning signs	5
2.3. Safety precautions	6
3. General information	7
3.1. Digital in general	7
4. Technical specifications	8
4.1. ThinkTop, PLC 8-30 or 110 VAC interface	8
5. Installation	12
5.1. Installation on air actuators	12
5.2. Installation on Series 700 valves	15
5.3. Air connections	16
5.4. Electrical connection, internal	17
6. Setup diagram	18
6.1. ThinkTop® setup utilising IR keypad	18
6.2. ThinkTop® setup utilising local 'I' and 'II' keys	20
6.3. ThinkTop® Quick setup guide	22
7. Troubleshooting	24
7.1. Troubleshooting and LEDs	24
8. Maintenance	27
8.1. Dismantling the ThinkTop®	27
8.2. Assembling the ThinkTop®	29
8.3. Dismantling and assembly of Series 700 valves	31
9. Parts list and Service Kits	33
9.1. Drawings for ThinkTop Digital 8-30 or 110 VAC NO/NC	33
9.2. ThinkTop Digital 8-30 or 110 VAC NO/NC	34
9.3. Drawings for ThinkTop Series 700 Valves	37
9.4. ThinkTop Series 700 Valves	38

1 EC Declaration of Conformity

The designating company

Alfa Laval

Company Name

Albuen 31, DK-6000 Kolding, Denmark

Address

+45 79 32 22 00

Phone No.

hereby declare that

Top Unit for Valve Control & Indication

Denomination

ThinkTop® Digital VAC

Type

29/12-09

Year

is in conformity with the following directives with amendments:

- Low Voltage Directive (LVD) 2006/95/EF
- EMC Directive 2004/108/EF
- ROHS Directive 2002/95/EEC

Manager, Product Centres,
Compact Heat Exchangers & Fluid Handling

Title

Bjarne Søndergaard

Name

Alfa Laval Kolding
Company

Signature

Designation



*Unsafe practices and other important information are emphasized in this manual.
Warnings are emphasized by means of special signs. All warnings in the manual are summarized on this page.
Pay special attention to the instructions below so that severe personal injury or damage to the top unit are avoided.*

2.1 Important information

Always read the manual before using the top unit!

WARNING

Indicates that special procedures must be followed to avoid serious personal injury.

CAUTION

Indicates that special procedures must be followed to avoid damage to the ThinkTop®.

NOTE

Indicates important information to simplify or clarify procedures.

2.2 Warning signs

General warning:



Dangerous electrical voltage:



Caustic agents:



2 Safety

*Unsafe practices and other important information are emphasized in this manual.
Warnings are emphasized by means of special signs. All warnings in the manual are summarized on this page.
Pay special attention to the instructions below so that severe personal injury or damage to the top unit are avoided.*

2.3 Safety precautions

Installation

Always read the technical data thoroughly.



Never install the ThinkTop® before valve or relay is in a safe position.



If welding close to the ThinkTop®: **Always** earth close to the welding area.



Disconnect the ThinkTop®.



Always have the ThinkTop® electrically connected by authorised personnel.



Maintenance

Always read the technical data thoroughly.



Always fit the seals between valve and ThinkTop® correctly.



Never service the ThinkTop® before valve or relay is in a safe position.



Never service the ThinkTop® with a valve/actuator under pressure.



Never clean the ThinkTop® with high-pressure cleaning equipment.



Never use cleaning agents when cleaning the ThinkTop®. Check with cleaning agent supplier.



Unsafe practices and other important information are emphasized in this manual.

Warnings are emphasized by means of special signs. All warnings in the manual are summarized on this page.

Pay special attention to the instructions below so that severe personal injury or damage to the top unit are avoided.

3.1 Digital in general

The ThinkTop is designed to ensure optimum valve control in conjunction with Alfa Laval valves and it is compatible with most PLC systems (Programmable Logic Controllers maker with PNP/NPN interface).

The ThinkTop can be equipped with 0-3 solenoid valves. The solenoids are electrically controlled by the Digital PLC and when activated the compressed air is activating the air actuator. All solenoids have built-in throttle function on both air inlet and outlet which means that is possible to control the opening and closing time of the air actuator. The solenoids are also equipped with a manual hold override.

Visual LED lights are constantly indicating the status of the unit: Valve positions, solenoid energized, setup and local fault indication etc.

The ThinkTop is characterized by a simple and modular design. It is exchangeable and is prepared for upgrading.

4 Technical specifications

Unsafe practices and other important information are emphasized in this manual.

Warnings are emphasized by means of special signs. All warnings in the manual are summarized on this page.

Pay special attention to the instructions below so that severe personal injury or damage to the top unit are avoided.

4.1 ThinkTop, PLC 8-30 or 110 VAC interface

“No Touch” sensor system

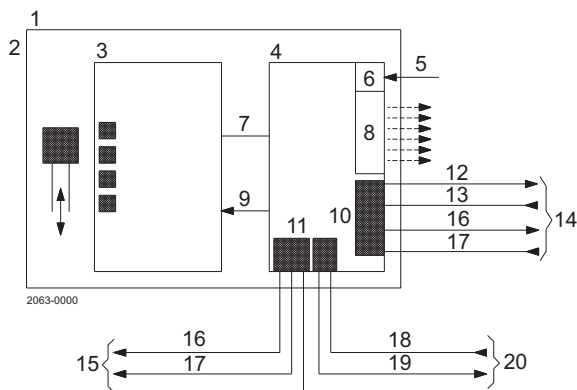

- | | |
|------------------------|--------------------------|
| 1. Sensor unit | 11. Terminals |
| 2. PLC, feedback | 12. Feedback signals |
| 3. Sensor board | 13. Solenoid signals |
| 4. PLC interface board | 14. PLC Cable |
| 5. IR Remote control | 15. Internal connections |
| 6. IR Rx | 16. Solenoid signals |
| 7. Serial link | 17. Solenoid common |
| 8. LEDs | 18. (PNP) |
| 9. +5 V | 19. Supply sensors |
| 10. Terminals | 20. External connections |

Type: Alfa Laval “No Touch” System. For wire connections: See 5.4 Electrical connection, internal“.

Features

- Tolerance programmes.
- Self adjustment programme (SRC/ARC valves only).
- Built-in maintenance monitor.
- Setup by internal push buttons or remote control (IR Keypad).
- Setup and local fault supervision.
- Setup saved at power shutdown.
- Visual LED Indicator lights.

Sensor System

Unique “No Touch” sensor system without any mechanical sensor adjustments. A magnet (indication pin) is mounted on the valve stem and the magnetic field (axial) is detected by sensor chips inside the sensor board. The measuring angle from each chip is used to locate the current position of the valve stem with an accuracy of ± 0.1 mm. Note that the distance to the indication pin can be $5 \text{ mm} \pm 3 \text{ mm}$.

Feedback signals

The sensor system can be used for 4 feedback signals + 1 status signal = 5 digital PNP/NPN feedback signals. Selection of PNP or NPN is done by a jumper. Two of the feedback signals can be used for external sensors if necessary.

The status signal is used for detection of the following three conditions:

- A set-up is in progress.
- Internal error.
- Maintenance is required (based on time and/or the self adjustment programme).

Tolerance programme

Individual programme according to valve types.

- | | |
|---------|--|
| Type 0: | Bypass valve type / keep present valve type. |
| Type 1: | SRC/ARC and Series 700 valves, only when self adjustment is enabled - Not recommended. |
| Type 2: | LKB (LKLA-T). |
| Type 3: | Unique Mixproof, SMP-SC Spillage-Free, and SRC-PV. |
| Type 4: | SMP-SC, SMP-TO, SMP-BC, SMP-BCA, SBV, SRC, ARC, Unique SSV, Unique SSV Aseptic, Unique-TO and Series 700 valves. |
| Type 5: | All Parameters Set To Default (also valid for MH valve and SMP-EC (seat-lift indication not possible for SMP-EC)). |

Preset and reset values: Tolerance programme No./Type 5 (± 5 mm) and all functions are disabled.

Note! Important to select the right tolerance programme in order to ensure optimum controlled closeness of valves.

4 Technical specifications

Unsafe practices and other important information are emphasized in this manual.

Warnings are emphasized by means of special signs. All warnings in the manual are summarized on this page.

Pay special attention to the instructions below so that severe personal injury or damage to the top unit are avoided.

Self Adjustment (SRC/ARC valves only)

The self adjustment feature is an exceptional aspect of the ThinkTop design. A programme can be activated to allow an adjustment of the tolerance band if the seals in the valve are being compressed or are worn. When the tolerance band of the unit has been adjusted 0.3 mm, an alert warning will appear in the form of a status signal and a flashing maintenance LED. After 0.5 mm adjustment an alarm warning appears: Loss of feedback signal, status signal and steady maintenance light indicating a replacement of the seal.

Built-in Maintenance Monitor

The unit can be preset to indicate when the time for maintenance of the valve has been reached. A status signal and flashing maintenance LED can be programmed to return after 3, 6, 9 or 12 months or more.

Technical specifications

Sensor system

Sensor accuracy:± 0.1 mm.
Distance to indication pin:5 ± 3 mm.
Stroke length:0.1 - 80 mm.

Electrical connection:

Direct main cable gland entry (hard wired) PG11 (ø4 - ø10 mm).
Direct external/sensor cable gland entry PG7 (ø3 - ø6.5 mm) option, external sensor.

Terminals

The terminal row of the sensor unit is equipped with screw terminals for both internal as well as external cables and wires. The terminals are suitable for wires up to 0.75 mm² (AWG 19).

Power Supply, must meet the requirements of EN 61131-2.

The ThinkTop® is designed to be a part of the PLC's Input/Output (I/O) system. It should be supplied from the same protected power supply as the other I/O devices. The I/O power supply should not be used for other kinds of loads.

The unit is reverse polarity and short circuit protected.
Supply voltage: 8 - 30 or 100 - 126.5 VAC.
Supply voltage nominal: 24 or 110 VAC (+15%, -10%) - pr. EN 61131-2.
Supply voltage absolute max.: 30 or 126.5 VAC.
Supply voltage absolute min.: 8 or 100 VAC.
Power consumption*): Max. 1.5 VA (8-30 VAC) or max. 2.0 VA (110 VAC) (for sensor unit alone)
(excluding current to the solenoids, external sensor and the PLC input current).

*) The initial current during power-on is higher. Typical values are 440 mA RMS during 10 ms (the first half cycle) followed by 270 ms at 2 x normal steady state current).

The fulfilling of the UL requirements in UL508 requires that the unit is supplied by an isolating source complying with the requirements for class 2 power units (UL1310) or class 2 and 3 transformers (UL1585).

Feedback signals

Output signals from the sensor unit to the connected PLC.

Nominal voltage: Must match the selected type of ThinkTop®.
Load current: Typically 50 mA, max. 100 mA.
Voltage drop: Typically 3 V at 50 mA.

4 Technical specifications

Unsafe practices and other important information are emphasized in this manual.

Warnings are emphasized by means of special signs. All warnings in the manual are summarized on this page.

Pay special attention to the instructions below so that severe personal injury or damage to the top unit are avoided.

External sensors

The external sensors are used for seat-lift supervision when seat-lift can not be internally detected. The sensors get their supply voltage from the terminal row. The output signals from the sensors are connected to two inputs on the terminal row on the internal sensor unit. If the actual setup is set for internal seat-lift, the corresponding external signal is not used, otherwise the external signal logically controls the corresponding feedback to the PLC (Programmable Logic Controller).

Note! If using external sensor, the sensor must be active/activated when performing a setup routine of the control head.

Supply voltage:	Must match the selected type of ThinkTop®.
Supply current:	Max. 15 mA per sensor.
Type of sensor:	2 wire VAC (EN60947-5-2).
Sensor cable length:	Max. 3 m.

Polarity

NO or NC function is selected with a jumper in term. 12 and 13.

Jumper present = NO. If changing to NC remove the jumper and make a power recycle. A power recycle is always required when changing this function.

ThinkTop Visual Indications

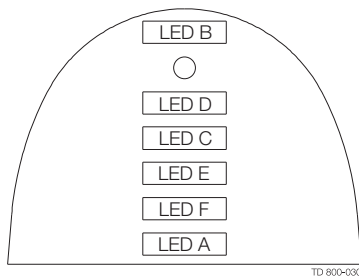

LED Indications

LED B	“Open valve” (Yellow)
O	IR-Receiver
LED D	“Setup/Internal fault” (Red)
LED C	“Seat-lift 1/2” (Yellow)
LED E	“Solenoid valves” (Green)
LED F	“Maintenance” (Orange)
LED A	“Closed valve” (Yellow)

Note: If the programmer wishes to detect a physical closed valve position in an “Open Valve” sensor position, then there is no longer any consistence between the sensor valve detection position and the visual indications of the ThinkTop.

Technical specifications solenoid valves

Solenoid signals Three output signals (with one common, terminal 11) from the terminal row are used for activation of the solenoids. Depending on the PLC used, the common could be either positive (connected with terminal 9) or negative for DC voltage. The signals are galvanically isolated from the sensor circuits.

4 Technical specifications

Unsafe practices and other important information are emphasized in this manual.

Warnings are emphasized by means of special signs. All warnings in the manual are summarized on this page.

Pay special attention to the instructions below so that severe personal injury or damage to the top unit are avoided.

Internal connections Terminals for connection of the solenoids mounted internally in the control head. The number of solenoids actually mounted in the control head could be 0 - 3. The signals are taken directly from the terminal row.

Technical specifications	
Up to 3 solenoid valves in each unit.	
Type	3/2 or 5/2 valve (only possible with one 5/2 valve).
Air supply	300-900 kPa (3-9 bar).
Filtered air, max. particles or dirt	5 μ 5-5 mg/m ³ .
Max. flow	180 l/min.
Max. oil content	1 mg/m ³ .
Max. water content	0.88 g/m ³ -20 °C compressed air.
Throughput	ø2.5 mm.
Air restriction (throttle function) air inlet/outlet.	Yes.
Manual hold override.	Yes.
External air tube connection	ø6 mm or 1/4" (specify when ordering).
Nominal voltage	24 or 110 VAC
Nominal power	1.0 W.
Silencer/filter *)	Connection possible via ø6 mm or 1/4". (Filter recommended in tropical regions).
Materials	
Plastic parts	Nylon PA12.
Steel parts	Stainless steel AISI 304 and 316
Seals	Nitrile (NBR), EPDM rubber for SMP-EC actuator stem.
Gore vent. membrane	PBT plastic.

*) **Note!** Filter recommended in tropical regions.

Micro environment demand specifications

Temperature		
Working:	-20°C to +85°C	IEC 68-2-1/2
Storage:	-40°C to +85°C	IEC 68-2-1/2
Temperature change:	-25°C to +70°C	IEC 68-2-14
Vibration		
	10-55 Hz, 0.7 mm	IEC 68-2-6
	55-500 Hz, 10g	
	3 x 30 min, 1 octave/min	
Drop test		
		IEC 68-2-32
Humidity		
Constant humidity:	+40°C, 21 days, 93% R.H.	IEC 68-2-3
Cyclic humidity:	+25°C/+55°C	
	12 cycles	IEC 68-2-30
(working)	93% R.H.	
Protection class		
	IP66 and IP67	IEC 529
Input treshold		
Voltage/current:	Type 1 input requirements	EN 61131-2
Solenoid signals		
isolation voltage	(1000 + 2 x 117) VAC ms/1 min	EN61131-2
EMC Directive		
	2004/108/EF	EN 61000-6-3, EN 61000-6-2
UL/CSA Approval		
	8-30 VAC	UL 508-E203255
	110 VAC	UL 508-E203664

*) Max. 31 ThinkTop units on a single master/gateway. **) Max. 62 ThinkTop units on a single master/gateway.

5 Installation

Unsafe practices and other important information are emphasized in this manual.

Warnings are emphasized by means of special signs. All warnings in the manual are summarized on this page.

Pay special attention to the instructions below so that severe personal injury or damage to the top unit are avoided.

5.1 Installation on air actuators

Step 1



Always read the technical data thoroughly.



Always have the ThinkTop® electrically connected by authorised personnel.

Step 2

1. Fit the air fittings on actuator if not mounted.
2. Fit the activator stem (magnet) and tighten **carefully** with a spanner.

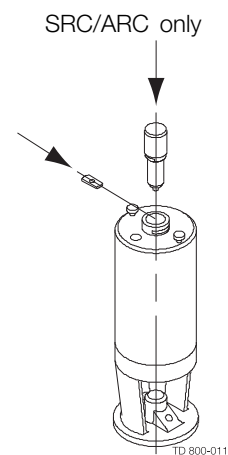

Step 3

1. Place the ThinkTop on top of the actuator.
2. Make sure X-ring is mounted.

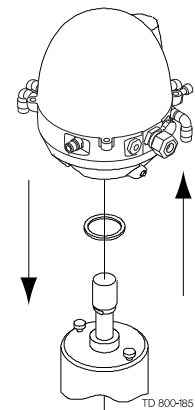

Step 4

1. Ensure that the unit is correctly mounted by **pressing** down on top of the ThinkTop.
2. Tighten the two Allen screws **carefully** (1.50 Nm).
3. Turn the actuator to have LEDs in a front view.

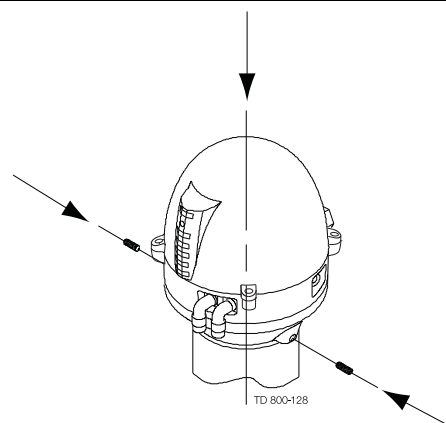

Unsafe practices and other important information are emphasized in this manual.

Warnings are emphasized by means of special signs. All warnings in the manual are summarized on this page.

Pay special attention to the instructions below so that severe personal injury or damage to the top unit are avoided.

Step 5

Fit the $\varnothing 6$ mm (1/4") air tubes to ThinkTop.
(see drawing "Air connections" page 16).

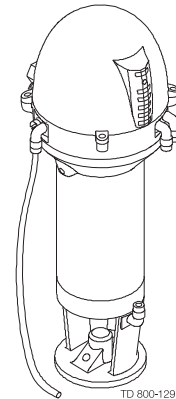

Step 6

Fit the air tubes to the actuator
(see drawing "Air connections" page 16).

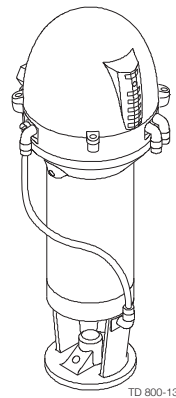

Step 7

Tighten the four screws and pull off cover of ThinkTop.

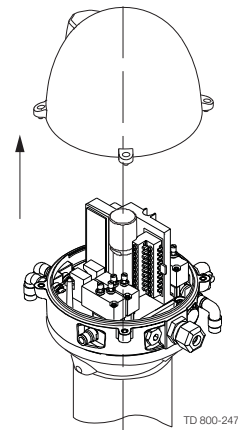

Step 8

1. Install cable (if not present) through the cable gland.
2. Connect the ThinkTop electrically
(see page 5.4 Electrical connection, internal).

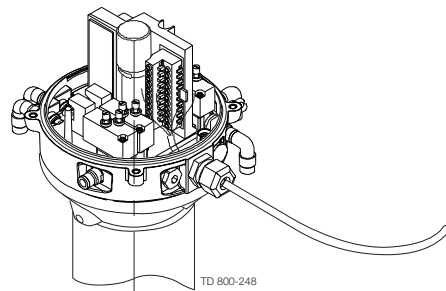

5 Installation

Unsafe practices and other important information are emphasized in this manual.

Warnings are emphasized by means of special signs. All warnings in the manual are summarized on this page.

Pay special attention to the instructions below so that severe personal injury or damage to the top unit are avoided.

Step 9

Make sure the cable gland is completely tightened.

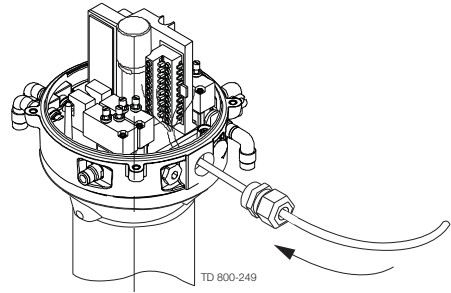

Step 10

Set up the ThinkTop (see chapter 6 Setup diagram).

NOTE!

The unit can be set up with the cover installed by using the IR keypad. To energize the valve, use a separate air tube or be in radio contact with the control room.

Unsafe practices and other important information are emphasized in this manual.

Warnings are emphasized by means of special signs. All warnings in the manual are summarized on this page.

Pay special attention to the instructions below so that severe personal injury or damage to the top unit are avoided.

5.2 Installation on Series 700 valves

Step 1

1. Remove the cover by loosening the four cover screws.
2. Separate the adapter from the base by loosening the three recess screws on top of the base.

Installation on air actuators:

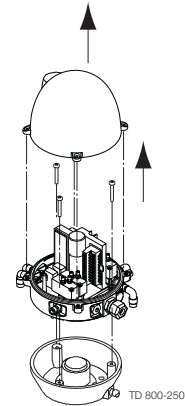

Step 2

1. Fit air fittings on actuator.
2. Position packing retainer in recess on actuator top.
3. Fit counter nut and indication pin (magnet) on actuator rod. Engage approx. 1/4" thread. Tighten counter nut and indicator with two wrenches.

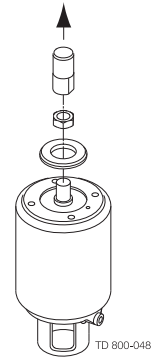

Step 3

1. Place the two O-rings in the grooves in the bottom of the adapter. Then place the adapter on the actuator top. The small O-ring must be positioned over the air hole on the actuator.
2. Fasten the adapter with the four 5/16" Allen screws.

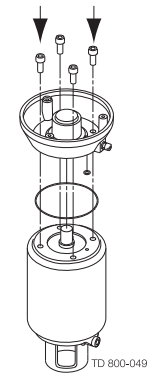

Step 4

Mount the base on the adapter in the position needed (can be rotated 120° in both directions). Note that one of the screw towers on the adapter has a guide recess (see * on drawing).

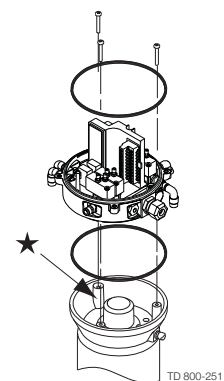

5 Installation

Unsafe practices and other important information are emphasized in this manual.

Warnings are emphasized by means of special signs. All warnings in the manual are summarized on this page.

Pay special attention to the instructions below so that severe personal injury or damage to the top unit are avoided.

5.3 Air connections

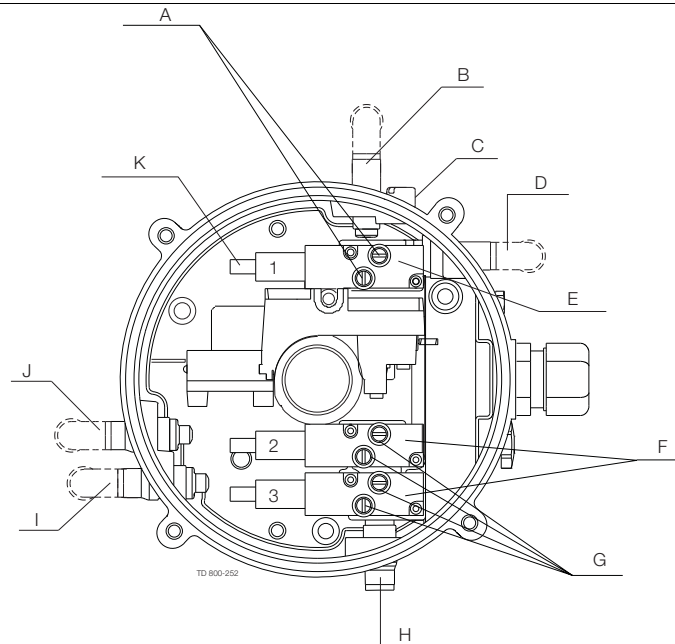

- A. Air restriction (throttle function) air inlet/outlet
- B. Air out 1A
- C. Air exhaust
- D. Air out 1B (5/2 port solenoid valve only)
- E. Solenoid 3/2 or 5/2
- F. 3/2 Solenoid valves only
- G. Air restriction (throttle function) air inlet/outlet
- H. Air in
- I. Air out 3
- J. Air out 2
- K. Manual hold override

Unsafe practices and other important information are emphasized in this manual.

Warnings are emphasized by means of special signs. All warnings in the manual are summarized on this page.

Pay special attention to the instructions below so that severe personal injury or damage to the top unit are avoided.

5.4 Electrical connection, internal

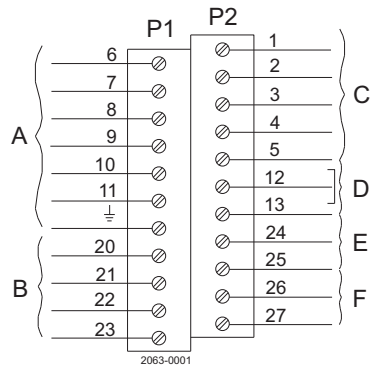

<p>A Digital interface command signals</p> <p>B Internal connections to solenoid 1-3 (***)</p> <p>6 Solenoid 1</p> <p>7 Solenoid 2</p> <p>8 Solenoid 3</p> <p>9 Supply ~</p> <p>10 Supply ~</p> <p>11 Solenoid common Earth</p> <p>20 Solenoid common</p> <p>21 Solenoid 1</p> <p>22 Solenoid 2</p> <p>23 Solenoid 3</p>	<p>C Feedback signals to digital interface</p> <p>D Jumper connections (**)</p> <p>E Incoming signals from external sensors (****)</p> <p>F Supply to external sensors (*)</p> <p>1 Closed valve</p> <p>2 Open valve</p> <p>3 Seat-lift 1</p> <p>4 Seat-lift 2</p> <p>5 Status</p> <p>12 NO/NC Jumper (**)</p> <p>13 NO/NC Jumper (**)</p> <p>24 Seat-lift 1 "upper" (*)</p> <p>25 Seat-lift 2 "lower" (*)</p> <p>26 Supply ~*) common ~</p> <p>27 Earth</p>
--	--

Table 1. Note!

- *) Terminals 24, 25, 26 and 27 can be used for external seat lift sensors as well as for any digital input. Always use an external PNP sensor. Two external signals can be connected, they are associated with feedback signal 3 (seat lift 1) and 4 (seat lift 2). External sensor must always be a 8-30 VDC PNP 3 wire sensor. Connect (-) common on terminal 27, and (+) common on terminal 26. The signals from the external sensors are associated as follows: sensor signal on terminal 24 (seat lift 1) associated with feedback 3 (seat lift 1), and sensor signal on terminal 25 (seat lift 2) associated with feedback 4 (seat lift 2).
- ***) Jumper present = PWM. See section 3.1.3 "Technical specifications solenoid valves".
- ****) Internal connections: Terminals for connection for the solenoids mounted internally in the control head. The number of solenoids actually mounted in the control head could be 0 - 3. The signals are taken directly from the terminal row.
- *****) If using external sensor, the sensor must be active/activated when performing a set-up routine of the control head.

When using one power supply for sensor system and solenoid valves:

Example of connecting power supplies

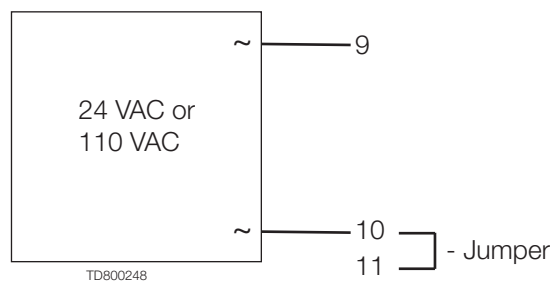

6 Setup diagram

Unsafe practices and other important information are emphasized in this manual.

Warnings are emphasized by means of special signs. All warnings in the manual are summarized on this page.

Pay special attention to the instructions below so that severe personal injury or damage to the top unit are avoided.

6.1 ThinkTop® setup utilising IR keypad

General

Flashing LED means no value set. Steady LED means value set as shown.

Default: Step 2, factory-set tolerance band +/- 5 mm
Step 3-8, disabled

D LED: Active during set-up: Flashing in step 1
Steady in all other steps

Or during operations, error condition: Steady showing hardware fault, indication pin out of range
Flashing showing software fault

Timeout: A 60 sec. timeout is started as soon as any button(s) are released
On timeout the setup is exited with no changes saved

IR Keypad: Remote distance 0-300 mm to ThinkTop®

Symbols

Push key on IR keypad with the same number

Simple representation of LED indication:

Yellow	B	<input type="checkbox"/>	
IR-Receiver		<input type="radio"/>	
Red	D	<input checked="" type="checkbox"/>	Steady LED
Yellow	C	<input type="checkbox"/>	
Green	E	<input type="checkbox"/>	
Orange	F	<input type="checkbox"/>	
Yellow	A	<input checked="" type="checkbox"/>	Flashing LED



General commands in each step (except step 1):

- | | | |
|----------------------------|-----------------------|--|
| <input type="checkbox"/> 0 | Next step / skip step | (In step 3-6 the program automatically moves to the next step when a position is stored) |
| <input type="checkbox"/> 5 | Clear / disable step | (In step 2 this resets the unit and sets the step 2-8 to default)
(The command is accepted when all unit LED's flash briefly) |

**It is recommended to reset the unit before performing a setup.
Always check for correct signals after the setup.**

6 Setup diagram

Unsafe practices and other important information are emphasized in this manual. Warnings are emphasized by means of special signs. All warnings in the manual are summarized on this page. Pay special attention to the instructions below so that severe personal injury or damage to the top unit are avoided.

Step 1 - Enter Setup

Next step: B C D E F A

1 Save and Exit
2 Exit no change accepted

Step 2 - Setup valve type

Next step: B C D E F A

<input type="checkbox"/> Default +/- 5mm	<input type="checkbox"/> SRC/ARC Series 700 (Only used when self adjustment feature is required)	<input type="checkbox"/> LKB (LKLA-T)	<input type="checkbox"/> Unique Mixproof SMP-SC SF <input type="checkbox"/> SRC-PV <input type="checkbox"/> AMP	<input type="checkbox"/> SMP-SC <input type="checkbox"/> SMP-BC <input type="checkbox"/> SMP-TO <input type="checkbox"/> SMP-BCA <input type="checkbox"/> SBV <input type="checkbox"/> Unique SSV <input type="checkbox"/> SRC/ARC Series 700	Unique 7000 Unique Mixproof PMO/Curd Unique Mixproof CP3/LP Unique Mixproof HT/VT Unique Mixproof 3A	Reset unit
	1	2	3	4		5

Step 3 - Set closed position

Next step: B C D E F A

Position stored.

Activate the valve to the close position (De-energized)

1

auto

Cleat position 5

Step 4 - Set open position

Next step: B C D E F A

Position stored.

Activate the valve to the open position (Energized)

1

auto

Clear position 5

Step 5 - Set upper seat lift.

Next step: B C D E F A

Position stored.

Activate the valve to upper seat lift. When using an external sensor the sensor must be active when "1" is pushed.

1

auto

Clear position 5

Step 6 - Set lower seat lift.

Next step: B C D E F A

Position stored.

Activate the valve to lower seat lift. When using an external sensor the sensor must be active when "1" is pushed.

1

auto

Clear position 5

Step 7 - Set self adjust (Recommended: Disabled)

Next step: B C D E F A

<input type="checkbox"/> Default Disabled	<input type="checkbox"/> Associated with closed/open position	<input type="checkbox"/> Associated with closed position	<input type="checkbox"/> Associated with open position	Disable function
1	2	3	5	

Step 8 - Setup maintenance

Next step: B C D E F A

<input type="checkbox"/> Default Disabled	<input type="checkbox"/> 90 days	<input type="checkbox"/> 180 days	<input type="checkbox"/> 270 days	<input type="checkbox"/> 360 days	Disable function
1	2	3	4	5	

6 Setup diagram

Unsafe practices and other important information are emphasized in this manual.

Warnings are emphasized by means of special signs. All warnings in the manual are summarized on this page.

Pay special attention to the instructions below so that severe personal injury or damage to the top unit are avoided.

6.2 ThinkTop® setup utilising local 'I' and 'II' keys

General

Default is: Step 2, tolerance is +/- 5 mm
Step 3-8, disabled

Timeout: A 60 sec. timeout is started as soon as any button(s) is released.
On timeout the setup is exited with no changes saved.

Flashing LED means no value set. Steady LED means value set as shown
[D] LED: Active during set-up: Flashing in step 1
Steady in all other steps

Or during operations, error condition: Steady showing hardware fault, indication pin out of range
Flashing showing software fault

General commands in each step (except step 1):

- | | | |
|-----------------|-----------------------|---|
| ① | Next step / skip step | (In step 3-6 the program automatically moves to the next step when a position is stored) |
| Ⓜ _{5s} | Clear / disable step | (In step 2 this resets the unit to default)
(The command is accepted when all unlit LED's flash briefly) |

It is recommended to reset the unit before performing a setup.

Symbols

- | | |
|-----------------|-------------------------|
| ① | Push local key "I" |
| Ⓜ | Push local key "II" |
| Ⓜ _{5s} | Hold key "II" for 5 sec |

Simple representation of LED indication:

Yellow	B	<input type="checkbox"/>	
IR-Receiver		<input type="checkbox"/>	
Red	D	<input checked="" type="checkbox"/>	Steady LED
Yellow	C	<input type="checkbox"/>	
Green	E	<input type="checkbox"/>	
Orange	F	<input type="checkbox"/>	
Yellow	A	<input type="checkbox"/>	
		<input checked="" type="checkbox"/>	Flashing LED



6 Setup diagram

Unsafe practices and other important information are emphasized in this manual.

Warnings are emphasized by means of special signs. All warnings in the manual are summarized on this page.

Pay special attention to the instructions below so that severe personal injury or damage to the top unit are avoided.

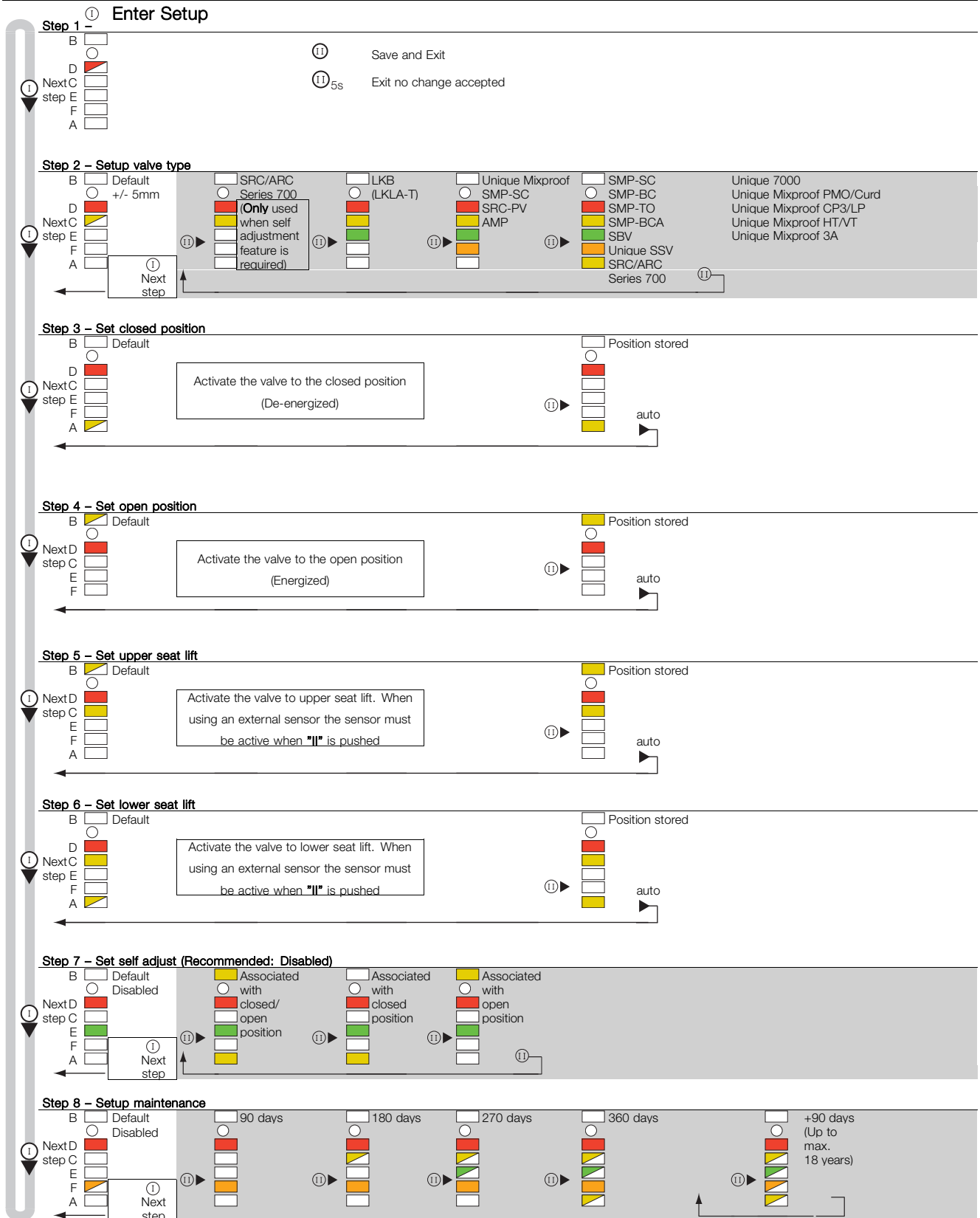

6 Setup diagram

Unsafe practices and other important information are emphasized in this manual.

Warnings are emphasized by means of special signs. All warnings in the manual are summarized on this page.

Pay special attention to the instructions below so that severe personal injury or damage to the top unit are avoided.

6.3 ThinkTop® Quick setup guide

Valve: Unique SSV, SRC/ARC type NC (selfadjustment disabled)

Push:		- and wait until red LED flashes
Push:		
Push:		- hold for 5 sec (clear all stored parameters)
Push:		(red + yellow LED)
Push:		(red + yellow + green LED)
Push:		(red + yellow + green + orange LED)
Push:		(red + yellow + green + orange + yellow LED)
Push:		
Push:		- to approve valve down (closed)
	Activate	Valve opens
Push:		- to approve (open)
Push:		(no upper seat-lift)
Push:		(no lower seat-lift)
Push:		(no self adjustment)
Push:		(no maintenance)
Push:		Red LED flashes (save & exit by push)



Setup done

Valve: SRC/ARC type NO (selfadjustment enabled)

Push:		- and wait until red LED flashes
Push:		
Push:		- hold for 5 sec (clear all stored parameters)
Push:		(red + yellow LED)
Push:		
	Activate	Valve closes
Push:		- to approve valve closed
Push:	Deactivate	Valve opens
Push:		- to approve valve is open
Push:		(no upper seat-lift)
Push:		(no lower seat-lift)
Push:		= self adjustment
Push:		
Push:		(no maintenance)
Push:		Red LED flashes (save & exit by push)



Setup done

Valve: LKB valve (Butterfly) NC

Push:		- and wait until red LED flashes
Push:		
Push:		- hold for 5 sec
Push:		(red + yellow LED)
Push:		(red + yellow + green LED)
Push:		
Push:		- to approve valve closed (indication stem up)
Push:	Activate	LKB valve- open position (indication-stem down)
Push:		- to approve valve is open
Push:		(no upper seat-lift)
Push:		(no lower seat-lift)
Push:		(no self adjustment)
Push:		(no maintenance)
Push:		Red LED flashes (save & exit by push)



Setup done

6 Setup diagram

Unsafe practices and other important information are emphasized in this manual.

Warnings are emphasized by means of special signs. All warnings in the manual are summarized on this page.

Pay special attention to the instructions below so that severe personal injury or damage to the top unit are avoided.

Valve: LKB valve (Butterfly) NO

Push:	I	- and wait until red LED flashes
Push:	I	
Push:	II	- hold for 5 sec (clear all stored parameters)
Push:	II	(red + yellow LED)
Push:	II	(red + yellow + green LED)
Push:	I	
	Activate	- to approve valve closed (indication stem up)
Push:	II	- to approve valve closed
Push:	Deactivate	LKB valve-open position (indication-stem up)
Push:	II	- to approve valve is open
Push:	I	(no upper seat-lift)
Push:	I	(no lower seat-lift)
Push:	I	(no self adjustment)
Push:	I	(no maintenance)
Push:	II	Red LED flashes (save & exit by push)



Setup done

Valve: Unique mixproof valve (with lower seat-lift)

Push:	I	- and wait until red LED flashes
Push:	I	
Push:	II	- hold for 5 sec (clear all stored parameters)
Push:	II	(red + yellow LED)
Push:	II	(red + yellow + green LED)
Push:	II	(red + yellow + green + orange LED)
Push:	I	
Push:	II	- to approve valve closed
	Activate	Valve opens
Push:	II	- to approve valve is open
Push:	I	(no upper seat-lift)
Push:	Activate	Lower seat-lift active
Push:	II	- to approve
Push:	I	(no self adjustment)
Push:	I	(no maintenance)
Push:	II	Red LED flashes (save & exit by push)



Setup done

7 Troubleshooting

Unsafe practices and other important information are emphasized in this manual.



Warnings are emphasized by means of special signs. All warnings in the manual are summarized on this page.

Pay special attention to the instructions below so that severe personal injury or damage to the top unit are avoided.



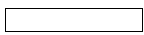

7.1 Troubleshooting and LEDs

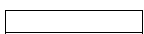
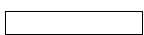
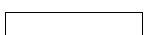
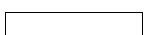
Below is stated the meaning of the LEDs' indications for fault finding in connection with the operation of the ThinkTop.

7.1.1 status LED (Red)

	Red flashing:	Unit in set-up mode or internal software fault. If internal software fault, re-programme unit.
		
	Red steady:	Unit in set-up mode or internal hardware fault. If internal hardware fault, check if magnet is in range and check correct wiring.
		
	Red steady:	No. communication between ThinkTop and the DeviceNet master, i.e. the bus is offline. If the Red LED is with random intervals and duration, it suggests that the bus is unstable, and the DeviceNet network should then be investigated. There are numerous issues that could lead to marginal operation of a network, bus load, voltage limits, impedance, termination, etc.
		
		

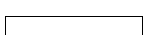
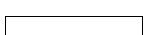
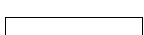
7.1.2 Maintenance time out

	1. Orange flashing:	Time for maintenance has run out. The unit has been self-adjusted into a maintenance alert condition. Valve maintenance is strongly recommended. After maintenance: Disabling of maintenance/self-adjustment function is required before setting new position, however, it is strongly recommended to make a complete new set-up after valve maintenance.
		
		
		
		
		
	2. Orange steady, yellow flashing (A and/or B):	The unit has been self-adjusted into a maintenance alarm condition and the feedback is lost (a minimum of seal left). Valve maintenance is required. After maintenance: Disabling of the self-adjustment function is required before setting new position, however, it is strongly recommended to make a complete new set-up after valve maintenance.

NOTE!

The maintenance indicator lighting up, and an open or closed light flashing..... =
Note the following:

- Self-adjustment programme is only valid for SRC/ARC valves, do not use the programme for other valve types.
- Use tolerance/valve type 1.
- In conjunction with valve type change-over; 21, 22, 31 and 32, the open position must be defined as the upper sensor position (when the indication pin is in the highest position).
- A loose top, indication pin or sensor system can also generate the alert/alarm condition.
- Removing a ThinkTop with self-adjust activated, will immediately generate an alarm condition! If the ThinkTop has to be removed, not because of a valve maintenance issue, but for some other reasons, and you want to store the already adjusted data
 - disable the self-adjust function before removing the ThinkTop and enable it again once the ThinkTop is back on the actuator.
- After valve maintenance a disabling of the self-adjustment function is required before setting a new position, however, it is strongly recommended to make a complete new set-up (disable all functions in step 2 valve type - and make a complete new set-up).

Unsafe practices and other important information are emphasized in this manual.

Warnings are emphasized by means of special signs. All warnings in the manual are summarized on this page.

Pay special attention to the instructions below so that severe personal injury or damage to the top unit are avoided.

7.1.3 Solenoid green LED always on

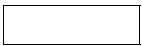
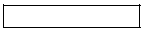
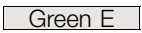
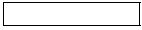
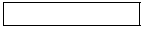
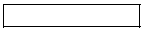

Condition: When using a ThinkTop 110VAC, the Green LED is always on, but the solenoids seems to operate properly.

Possible cause: The off state voltage of the solenoid input is not sufficiently low.

Corrective action: Make sure that the off state voltage is below 7V.

7.2 LED indication during normal operation

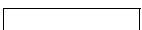
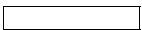
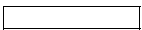
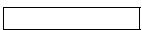

Yellow steady: Position A (closed valve).



Yellow steady: Position B (open valve).

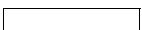
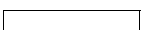
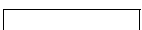
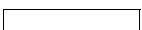
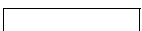
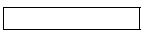
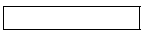

Yellow steady: Position C (Seat lift 1-2 or external sensors).

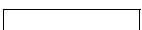
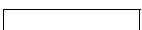
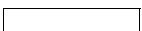

7 Troubleshooting

Unsafe practices and other important information are emphasized in this manual.

Warnings are emphasized by means of special signs. All warnings in the manual are summarized on this page.

Pay special attention to the instructions below so that severe personal injury or damage to the top unit are avoided.

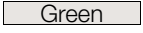
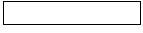
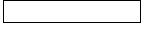
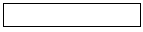

Green

Green steady:

Solenoid valves energized.

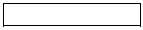
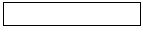

Note! During set-up LED lights have different functions.

Study the instructions carefully.
Handle scrap correctly.
Always keep spare X-rings in stock.

8.1 Dismantling the ThinkTop®

Step 1

- 1. Untighten the two Allen screws and remove the ThinkTop from the actuator.
- 2. Pull out X-ring (19) and replace it.

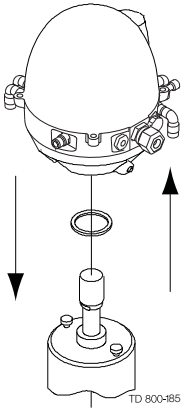

Step 2

- 1. Untighten the four screws.
- 2. Pull off cover of ThinkTop.
- 3. Remove X-ring (9) (grey).

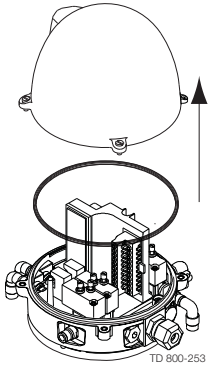

Step 3

- 1. Untighten screws.
- 2. Remove solenoid valves (up to three) and replace them with new ones.

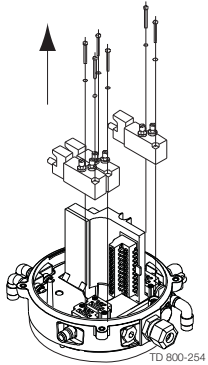

8 Maintenance

Study the instructions carefully.

Handle scrap correctly.

Always keep spare X-rings in stock.

Step 4

1. To dismantle the adapter (the lower part of the ThinkTop) from base (the middle part), unscrew the three screws.
2. Turn the lower part a little clockwise and pull.
3. Replace adapter if necessary.
4. Remove the black X-ring.

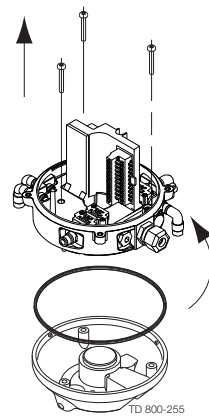

Note: Turn banjo connection!

Step 5

To remove the sensor unit untighten screw and pull out the sensor unit.

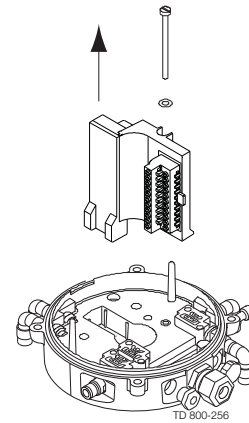

Study the instructions carefully.
Handle scrap correctly.
Always keep spare X-rings in stock.

8.2 Assembling the ThinkTop®

Step 1

Place sensor unit in base and tighten screw (torque: 1 Nm).

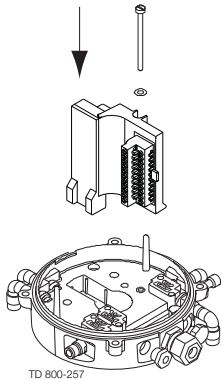

Step 2

- 1. Replace the black X-ring.
- 2. Assemble base with adapter by turning adapter slightly anticlockwise and tighten the four screws (1.9 Nm).

CAUTION!

Do NOT twist the X-ring in the groove!
The X-ring is not square; The highest (h) part must be placed as fig.

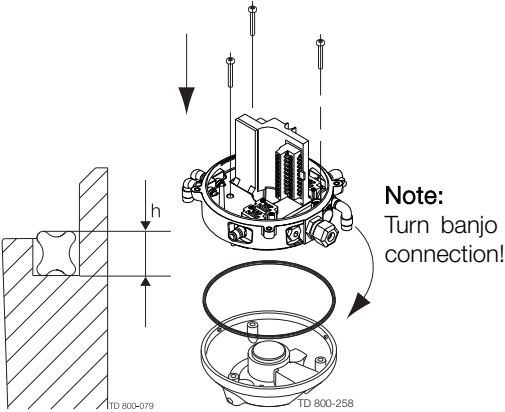

Step 3

- 1. Replace solenoid valves (up to three) with new ones.
- 2. Tighten screws (0.2 Nm).

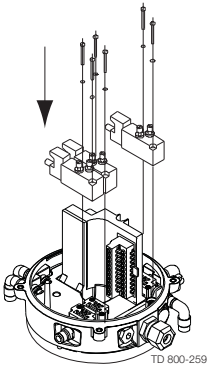

Step 4

- 1. Replace the grey X-ring.
- 2. Replace cover of ThinkTop and tighten the four screws (0.6 Nm).

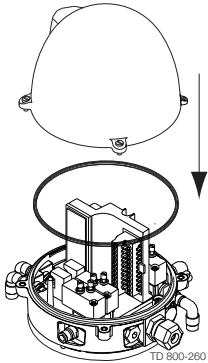

8 Maintenance

Study the instructions carefully.

Handle scrap correctly.

Always keep spare X-rings in stock.

Step 5

1. Replace the black X-ring.
2. Mount ThinkTop on actuator.

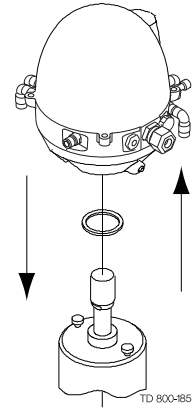

Study the instructions carefully.
 Handle scrap correctly.
 Always keep spare X-rings in stock.

8.3 Dismantling and assembly of Series 700 valves

Step 1

1. Remove the cover by loosening the four cover screws.
2. Separate the adapter from the base by loosening the three recess screws on top of the base.

Installation on air actuators:

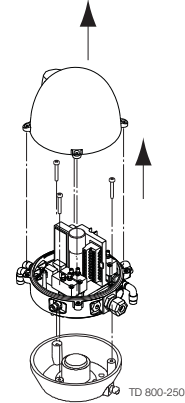

Step 2

1. Fit air fittings on actuator.
2. Position packing retainer in recess on actuator top.
3. Fit counter nut and indicator (magnet) on actuator rod. Engage approx. 1/4" thread. Tighten counter nut and indicator with two wrenches.

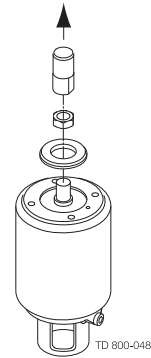

Step 3

1. Place the two O-rings in the grooves in the bottom of the adapter. Then place the adapter on the actuator top. The small O-ring must be positioned over the air hole on the actuator.
2. Fasten the adapter with the four 5/16" Allen screws.

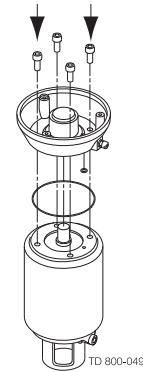

Step 4

1. Mount the base on the adapter in the position needed (can be rotated 120° in both directions). Note that one of the screw towers on the adapter has a guide recess (see * on drawing).
2. Remove x-rings (9) (grey) and (16) (black).
3. Replace with new ones.

CAUTION! Do NOT twist the X-ring in the groove! The X-ring is not square; The highest (h) part must be placed as fig.

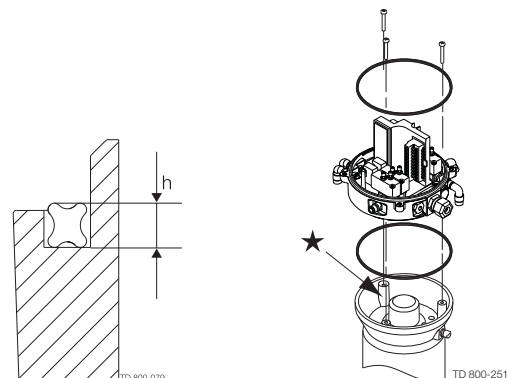

The drawings show ThinkTop Digital 8-30 or 110 VAC NO/NC.
 The items refer to the parts lists in the following sections

9.1 Drawings for ThinkTop Digital 8-30 or 110 VAC NO/NC

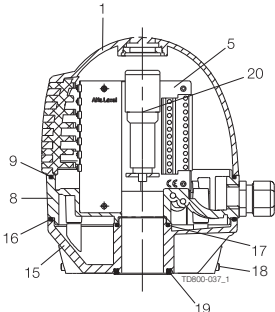
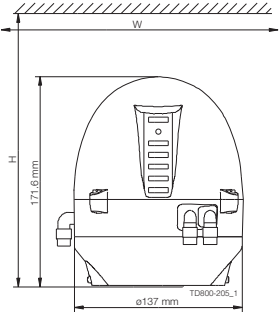

Note! This is the basic design

The clearance should be approximately:

W225 x H250	(Unique SSV NC, SMP-SC/ - BV/ -TO, Unique Mixproof, MH, SBV)
W225 x H320	(Unique SSV NO)
W225 x H300	(LKLA-T)

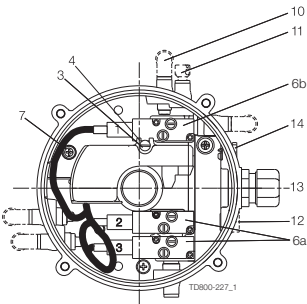

9 Parts list and Service Kits

The drawings show ThinkTop Digital 8-30 or 110 VAC NO/NC.
The items refer to the parts lists in the following sections

9.2 ThinkTop Digital 8-30 or 110 VAC NO/NC

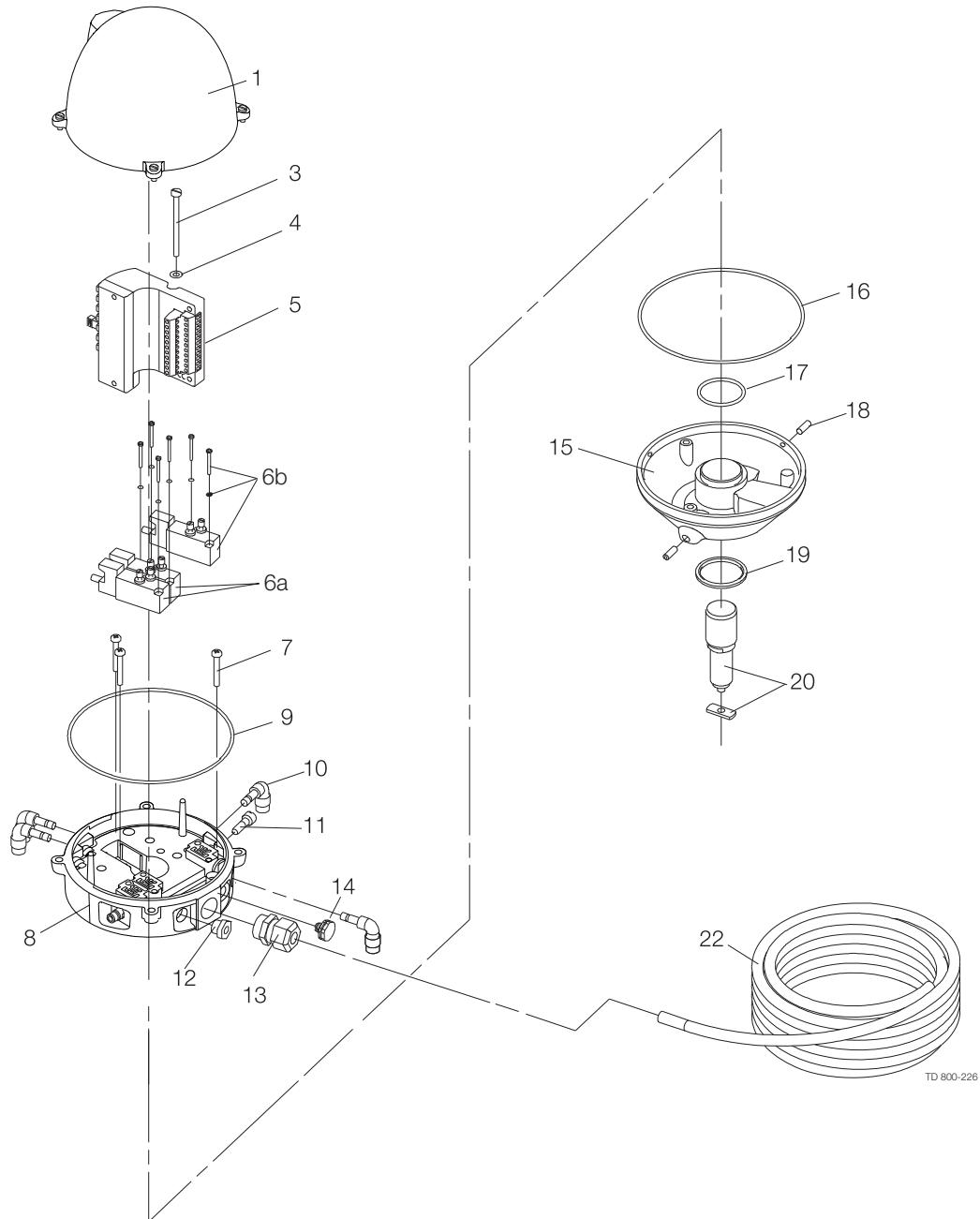

TD 800-226

9 Parts list and Service Kits

The drawings show ThinkTop Digital 8-30 or 110 VAC NO/NC.

The items refer to the parts lists in the following sections

Parts list

Pos.	Qty	Denomination
1	1	Shell
3	1	Screw
4	1	Washer
5	1	Sensor board
6a	1	Solenoid valve (3/2)
6b	1	Solenoid valve (3/2) or 5/2)
7	1	PT screw
8	1	Base
9	1	Special X-ring, grey
10	1	Air fittings
11	1	Blow-off valve
12	1	Thread plug, PG7, $\phi 3 - \phi 6,5$ mm
13	11	Cable gland, PG11 $\phi 4 - \phi 10$ mm
14	1	Gore Vent. membrane
15	1	Adapter
16	1	Special X-ring, black
17	1	O-ring
18	1	Allen screw
19	1	Special X-ring
20	1	Indication pin
21	1	5 m. flying PVC cable (12 x 0.5mm ²)

Service kits

Denomination	Intern number
Sensor unit Digital 8-30 VAC NO/NC	9612-5627-02
Sensor unit Digital 110 VAC NO/NC	9612-5627-05
Solenoid valve 3/2, 24 VDC	9611-99-3325
Solenoid valve 5/2, 24 VDC	9611-99-3328
Solenoid valve 3/2, 110 VDC	9611-99-3326
Solenoid valve 5/2, 110 VDC	9611-99-3329
Solenoid valve 3/2, 24 VDC	9611-99-3324
Solenoid valve 5/2, 24 VDC	9611-99-3327
Indication pin	9612-5623-01
Special indication pin, SRC-LS	9612-6370-01
Special indication pin, Unique SSV-LS	9613-1581-01
Air fitting, $\phi 6$ mm	9611-99-3405
Air fitting, 1/4"	9611-99-3433
Gore vent	9611-99-4722
X-ring, pos. 9	9613-4564-01
X-ring, pos. 16	9612-9994-01
X-ring, pos. 19	9612-5696-01

The drawings show ThinkTop Series 700 Valves
 The items refer to the parts lists in the following sections

9.3 Drawings for ThinkTop Series 700 Valves

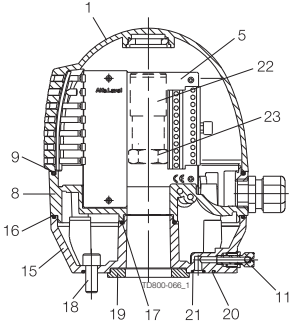
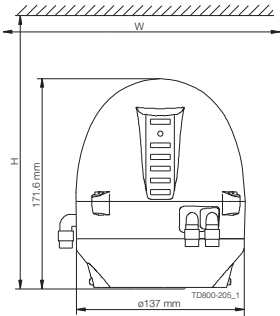

Note! This is the basic design	
The clearance should be approximately:	
W225 x H250	(Unique SSV NC, SMP-SC/ - BV/ -TO, Unique Mixproof, MH, SBV)
W225 x H320	(Unique SSV NO)
W225 x H300	(LKLA-T)

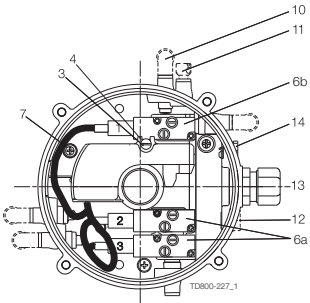

9 Parts list and Service Kits

The drawings show ThinkTop Series 700 Valves
The items refer to the parts lists in the following sections

9.4 ThinkTop Series 700 Valves

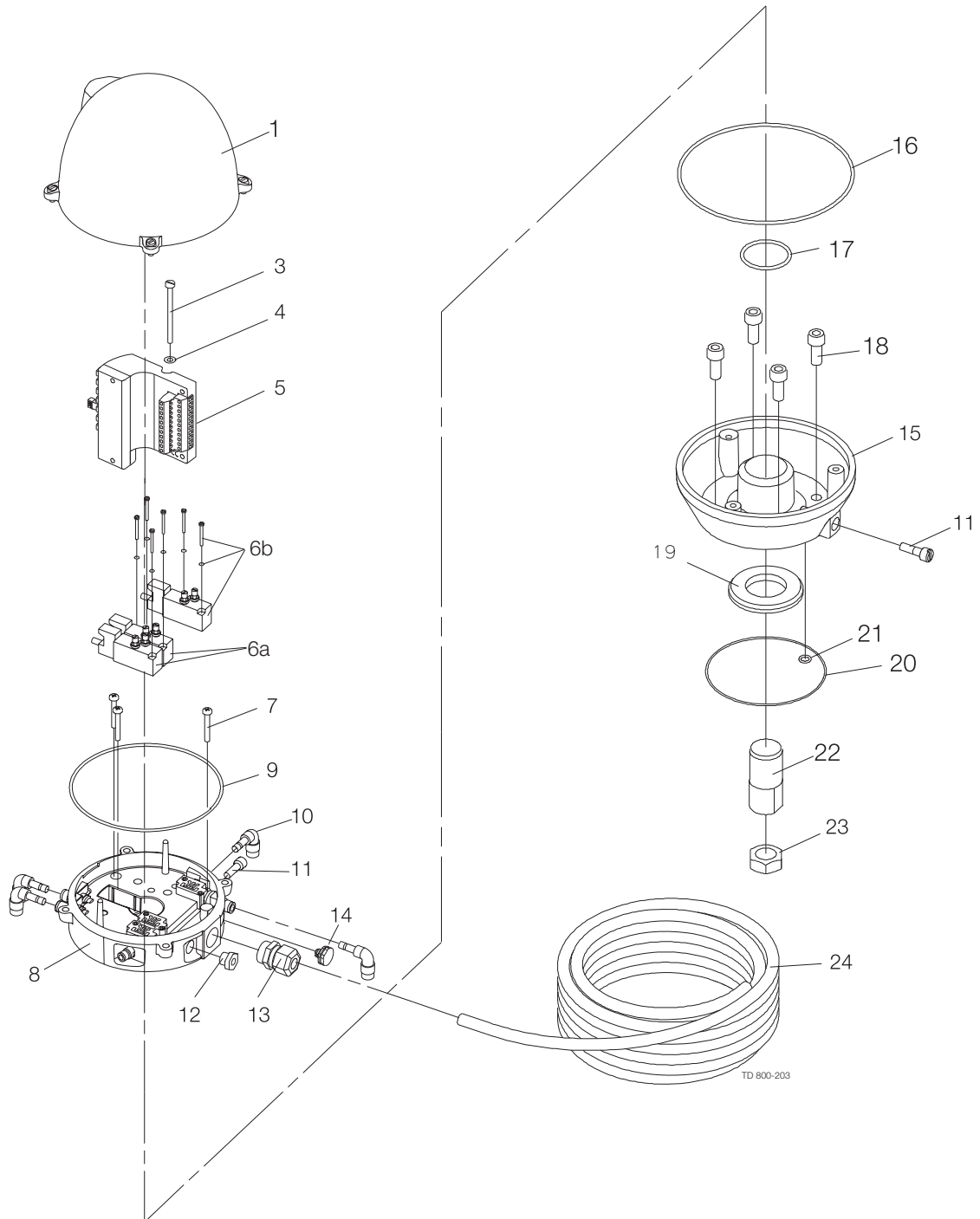

TD 800-203

9 Parts list and Service Kits

The drawings show ThinkTop Series 700 Valves
The items refer to the parts lists in the following sections

Parts list

Pos.	Qty	Denomination
1	1	Shell
3	1	Screw
4	1	Washer
5	1	Sensor board
6a	1	Solenoid valve (3/2)
6b	1	Solenoid valve (3/2 or 5/2)
7	1	PT screw
8	1	Base
9	1	Special X-ring, grey
10	1	Air fittings
11	1	Blow-off valve
12	1	Thread plug, PG7
13	1	Cable gland, PG11 4-10 mm
14	1	Gore Vent, menbarne
15	1	Adapter
16	1	Special X-ring, black
17	1	O-ring
18	1	Screw
19	1	Retainer
20	1	O-ring
21	1	O-ring
22	1	Indicator pin
23	1	Nut
24	1	5m. flying PVC cable (12 x 0.5mm ²)

Service kits

Denomination	1/4" Air connec.
Sensor unit Digital 8-30 VAC NO/NC	9612-5627-02
Sensor unit Digital 110 VAC NO/NC	9612-5627-05
Solenoid valve 3/2, 24 VDC	9611-99-3324
Solenoid valve 5/2, 24 VDC	9611-99-3327
Solenoid valve 3/2, 24 VDC	9611-99-3325
Solenoid valve 5/2, 24 VDC	9611-99-3328
X-ring, pos. 9	9613-4564-01
Solenoid valve 5/2, 110 VDC	9611-99-3329
Indication pin	9612-6357-02
Air fitting, 1/4"	9611-99-3433
Gore vent	9611-99-4722
X-ring, pos. 9	9613-4564-01
X-ring, pos. 16	9612-9994-01

How to contact Alfa Laval

Contact details for all countries are continually updated on our website.

Please visit www.alfalaval.com to access the information directly.

© Alfa Laval Corporate AB

This document and its contents is owned by Alfa Laval Corporate AB and protected by laws governing intellectual property and thereto related rights. It is the responsibility of the user of this document to comply with all applicable intellectual property laws. Without limiting any rights related to this document, no part of this document may be copied, reproduced or transmitted in any form or by any means (electronic, mechanical, photocopying, recording, or otherwise), or for any purpose, without the expressed permission of Alfa Laval Corporate AB. Alfa Laval Corporate AB will enforce its rights related to this document to the fullest extent of the law, including the seeking of criminal prosecution.