



RODEM®

PROCESS EQUIPMENT

www.rodem.com 800-543-7312

Instruction Manual

Toftejorg™ SaniJet™ 20 Air Driven

Versions included:

- Standard
- Hastelloy
- Q-Doc: Equipment Doc (3.1 Inspection Certificate - EN 10204)
- Q-Doc+FAT-SAT: Qualification Documentation incl. FAT and SAT)
- ATEX Certification in accordance with Directive 94/9/EC
- Improved surface finish (0.5 µm Ra internal/external media contact parts)

IM-TE91A793-EN10

ESE01829EN

Date of issue: April 3, 2014

First published: April 2009

Original manual

Instruction Manual

Contents

Contents	1
Toftejorg SaniJet 20 Air Driven, Product program	3
Air Driven: Toftejorg SaniJet 20 (3" connection)	3
Air Driven: Toftejorg SaniJet 20 (4" connection)	4
Accessories.....	6
Introduction	7
Intended Use	8
Patents and trademarks	8
ATEX Marking.....	9
General Description.....	10
Quality System.....	10
Functioning	11
Machine with External Motor Drive	12
Self-cleaning	13
Cleaning Pattern, The Golden Section.....	13
Performance Data for Toftejorg SaniJet 20 Air Driven	14

Instruction Manual - Installation

Contents	18
General Installation Instructions.....	19
Special Conditions for Safe Use in accordance with the ATEX Certification, Directive 94/9/EC	20
Installation of Air Motor	22

Instruction Manual - Operation

Contents	24
Normal Operation.....	25
Normal Operation of Air Motor	26
Safety Precautions.....	28
Safety Precautions for Air Motor	29

Instruction Manual - Maintenance

Contents	30
Preventive Maintenance	31
Reserved rights for design changes of Alfa Laval equipment used in validated processes	31
Service and repair of ATEX approved machines	32
Service and repair of machines ordered with Q-Doc.....	33
Every 300 working hours	34
Preventive Maintenance of Air Motor	35

Part List Drawing	36
Toftejorg SaniJet 20 Air Driven complete, Part List Drawing	37
Reference List of Parts	38
Toftejorg SaniJet 20A, Air Driven (EPDM as standard)	38
Toftejorg SaniJet 20 Air Driven with improved surface finish (EPDM as standard).....	40
Toftejorg SaniJet 20 Air Driven, Hastelloy version (FFKM as standard)	42
Dismantling and reassembling, Cleaner Unit	47
Dismantling and reassembling, Base Unit.....	48
Air motor Drive unit.....	50
Rotacheck System.....	51
Trouble Shooting Guide.....	52
Service Kits and Tools.....	54
Service Intervals	54
Service Kit in Viton for Toftejorg SaniJet 20 Air driven version	54
Service Kit in EPDM for Toftejorg SaniJet 20 Air driven version	54
Service Kit in Perlast for Toftejorg SaniJet 20 Air driven version	55
Tools	55
How to Order Spare Parts	56
How to contact Alfa Laval Tank Equipment.....	56
EU Declaration of Conformity with ATEX Certification	56
Declarations of Conformity per EN 10204 Type 2.2.....	58

Toftejorg SaniJet 20 Air Driven, Product program

This manual covers the product programme for Toftejorg SaniJet 20 Air Driven. For information on the media driven please refer to Instruction Manual IM-TE91A792.

Air Driven: Toftejorg SaniJet 20 (3" connection)

Standard (EPDM as standard)

Length	2xø2.0 mm	2xø3.8 mm	4xø4.2 mm
500mm	TE24B100	TE24B120	TE24B160
350mm	TE24B101	TE24B121	TE24B161
700mm	TE24B102	TE24B122	TE24B162
1000mm	TE24B104	TE24B124	TE24B164
1200mm	TE24B106	TE24B126	TE24B166
1500mm	TE24B108	TE24B128	TE24B168

Hastelloy C22 (FFKM as standard)

Length	2xø2.0 mm	2xø3.8 mm	4xø4.2 mm
500mm	TE24C100	TE24C120	TE24C160
350mm	TE24C101	TE24C121	TE24C161
700mm	TE24C102	TE24C122	TE24C162
1000mm	TE24C104	TE24C124	TE24C164
1200mm	TE24C106	TE24C126	TE24C166
1500mm	TE24C108	TE24C128	TE24C168

Improved surface finish* (EPDM as standard)

Length	2xø2.0 mm	2xø3.8 mm	4xø4.2 mm
500mm	TE24E100	TE24E120	TE24E160
350mm	TE24E101	TE24E121	TE24E161
700mm	TE24E102	TE24E122	TE24E162
1000mm	TE24E104	TE24E124	TE24E164
1200mm	TE24E106	TE24E126	TE24E166
1500mm	TE24E108	TE24E128	TE24E168

Improved surface finish* and Hastelloy C22 (FFKM as standard)

Length	2xø2.0 mm	2xø3.8 mm	4xø4.2 mm
500mm	TE24D100	TE24D120	TE24D160
350mm	TE24D101	TE24D121	TE24D161
700mm	TE24D102	TE24D122	TE24D162
1000mm	TE24D104	TE24D124	TE24D164
1200mm	TE24D106	TE24D126	TE24D166
1500mm	TE24D108	TE24D128	TE24D168

* Surface finish: 0.5 µm Ra internal/external media contact parts. 0.8 µm non media contact parts.
Passivated. Note: Nominal Surface Finish

Toftejorg SaniJet 20 Air Driven, Product program

Air Driven: Toftejorg SaniJet 20 (4" connection)

Standard (EPDM as standard)

Length	2xø2.0 mm	2xø3.8 mm	4xø4.2 mm
500mm	TE24G100	TE24G120	TE24G160
350mm	TE24G101	TE24G121	TE24G161
700mm	TE24G102	TE24G122	TE24G162
1000mm	TE24G104	TE24G124	TE24G164
1200mm	TE24G106	TE24G126	TE24G166
1500mm	TE24G108	TE24G128	TE24G168

Hastelloy C22 (FFKM as standard)

Length	2xø2.0 mm	2xø3.8 mm	4xø4.2 mm
500mm	TE24H100	TE24H120	TE24H160
350mm	TE24H101	TE24H121	TE24H161
700mm	TE24H102	TE24H122	TE24H162
1000mm	TE24H104	TE24H124	TE24H164
1200mm	TE24H106	TE24H126	TE24H166
1500mm	TE24H108	TE24H128	TE24H168

Improved surface finish* (EPDM as standard)

Length	2xø2.0 mm	2xø3.8 mm	4xø4.2 mm
500mm	TE24F100	TE24F120	TE24F160
350mm	TE24F101	TE24F121	TE24F161
700mm	TE24F102	TE24F122	TE24F162
1000mm	TE24F104	TE24F124	TE24F164
1200mm	TE24F106	TE24F126	TE24F166
1500mm	TE24F108	TE24F128	TE24F168

Improved surface finish* and Hastelloy C22 (FFKM as standard)

Length	2xø2.0 mm	2xø3.8 mm	4xø4.2 mm
500mm	TE24J100	TE24J120	TE24J160
350mm	TE24J101	TE24J121	TE24J161
700mm	TE24J102	TE24J122	TE24J162
1000mm	TE24J104	TE24J124	TE24J164
1200mm	TE24J106	TE24J126	TE24J166
1500mm	TE24J108	TE24J128	TE24J168

* Surface finish: 0.5 µm Ra internal/external media contact parts. 0.8 µm non media contact parts. Passivated. Note: Nominal Surface Finish

The item number must always be included with an add-on extension of **-XX**. (e.g. TE24G102-90)

Toftejorg SaniJet 20 Air Driven, Product program

Available add-on's

For: TE24BXXX, TE24EXXX, TE24GXXX, TE24FXXX	For: TE24HXXX, TE24CXXX, TE24JXXX, TE24DXXX
<ul style="list-style-type: none"> -0X (Standard) -5X Q-doc+FAT-SAT -6X Q-doc+FAT-SAT + ATEX -7X ATEX -8X Q-doc + ATEX -9X Q-doc -X0 EPDM (Standard) -X1 FPM (Viton) -X4 FFKM 	<ul style="list-style-type: none"> -0X (Standard) -5X Q-doc+FAT-SAT -6X Q-doc+FAT-SAT + ATEX -7X ATEX -8X Q-doc + ATEX -9X Q-doc -X4 FFKM (Standard)

Explanation to Add-on's:

Q-doc (Equipment Doc.) includes:



- Declaration of Compliance:
- EN 10204 type 3.1 inspection Certificate
 - FDA Declaration of Compliance
 - USP Class VI (if possible)
 - ADI Declaration
 - QC Declaration of Compliance

Q-doc+FAT-SAT (Qualification Doc) includes:



- Qualification Documentation:
- RS, Requirement Specification
 - DS, Design Specification incl. Traceability Matrix
 - FAT, Factory Acceptance Test incl. IQ & OQ
 - SAT, Site Acceptance Test Protocol incl. IQ & OQ for End-User Execution
 - Declaration of Compliance:
 - EN 10204 type 3.1 inspection Certificate
 - FDA Declaration of Compliance
 - USP Class VI (if possible)
 - ADI Declaration
 - QC Declaration of Compliance

ATEX includes:

ATEX approved machine for use in explosive atmospheres.

Cleaner unit category 1 for installation in zone 0/20 (inside tank) in accordance to Directive 94/9/EC. Ex II 1 GD c T140°C.

Air drive unit category 2 for installation in zone 1/21 (outside tank) in accordance to Directive 94/9/EC. Ex II 2 GD c IIC T4 Tamb -20°C to +40°C.

Toftejorg SaniJet 20 Air Driven, Product program

Accessories

Clamp Coupling Parts

Reference no.	Description
9611-31-019-0	Clamp welding liner 1"
9611-99-1358	Gasket EPDM f. 1" Clamp coupling
211053	Clamp ring 1"
9611-31-023-0	Clamp welding liner 3"
9611-99-1362	Gasket EPDM f. 3" Clamp coupling
211056	Clamp ring 3"
9611-31-024-0	Clamp welding liner 4"
9611-99-1363	Gasket EPDM f. 4" Clamp coupling
211057	Clamp ring 4"

Monitoring

An electronic system with rotation sensor to validate 360° coverage can be included:

TE52E067 Rotacheck Sensor ø27 mm

TE52E058 Rotacheck Relay

For further information see page 51.

Introduction

This manual has been prepared as a guide for installation and for the persons who will be operating and maintaining your tank cleaning machine. The key to long life for your tank cleaning machine is a carefully planned system for preventive maintenance; you must appreciate that a tank cleaning machine which has a rough and dirty job to do will need more frequent attention than one working under ideal conditions.

Note: Get the best and most economical performance from your tank cleaning machine. Insufficient preventive maintenance means poor performance, unscheduled stops, shorter lifetime and extra costs. Good preventive maintenance on the contrary means good performance, no unscheduled stops and superior total economy.

The information in this manual is simple to follow, but should you require further assistance, our Customer Service Department and world-wide net of Distributors will be pleased to help you. Please quote the type, article and serial number with all your enquiries; this will help us to help you. The type, article and serial number are laser engraved on the Base house of the tank cleaning machine.

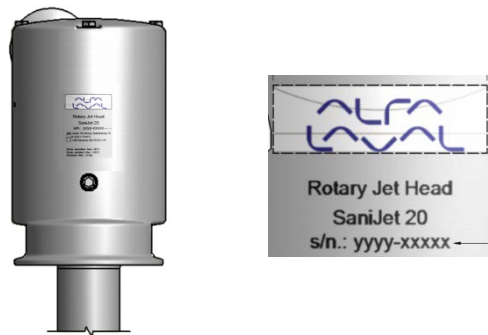

Warning:



Before installing the machine and setting it into operation carefully read the General Installation Instructions (page 19) and the Safety Precautions (page 28) and take all necessary precautions according to your application and local regulations.

© Alfa Laval Corporate AB

This document and its contents is owned by Alfa Laval Corporate AB and protected by laws governing intellectual property and thereto related rights. It is the responsibility of the user of this document to comply with all applicable intellectual property laws. Without limiting any rights related to this document, no part of this document may be copied, reproduced or transmitted in any form or by any means (electronic, mechanical, photocopying, recording, or otherwise), or for any purpose, without the expressed permission of Alfa Laval Corporate AB. Alfa Laval Corporate AB will enforce its rights related to this document to the fullest extent of the law, including the seeking of criminal prosecution.

Intended Use

It is to be verified by the end-user:

- that the tank cleaning machine is in conformity with respect to tank, vessel or container size in which it will be used.
- that the construction materials (both metallic and non-metallic) are compatibility with product, flushing media, cleaning media, temperatures and pressure under the intended use.

Patents and trademarks

This Instruction Manual is published by Alfa Laval Kolding A/S without any warranty. Improvements and changes to this Instruction Manual may at any time be made by Alfa Laval Kolding A/S without prior notice. Such changes will, however, be incorporated in new editions of this Instruction Manual.

© Alfa Laval Kolding A/S. All rights reserved.

The Alfa Laval logotype is a trademark or a registered trademark of Alfa Laval Corporate AB. "Toftejorg" and "SaniJet" are trademarks or registered trademarks of Alfa Laval Kolding A/S. The Toftejorg™ SaniJet™ 20 product has patents in the EPO member states, in the US and in other countries. Other products or company names mentioned herein may be the trademarks of their respective owners. Any rights not expressly granted herein are reserved.

ATEX Marking

The Toftejorg SaniJet 20A Cleaner unit is certified as category 1 component for installation in zone 0/20 (inside tank) in accordance to Directive 94/9/EC. The certification is carried out by the Certification body SGS Baseefa, who has issued the certificate no. 1180 Baseefa 05ATEX0117X. Marked:  II 1 GD c T140°C

The Toftejorg SaniJet 20A Air drive unit is certified as category 2 component for installation in zone 1/21 (outside tank) in accordance to Directive 94/9/EC. The certification is carried out by Alfa Laval as a Own Assessment and archived at Certification body Teknologisk Institut. Registered as archive no.: DTI-2013-1-0148A. Marked:  II 2 GD c IIC T4 Tamb -20°C to +40°C.

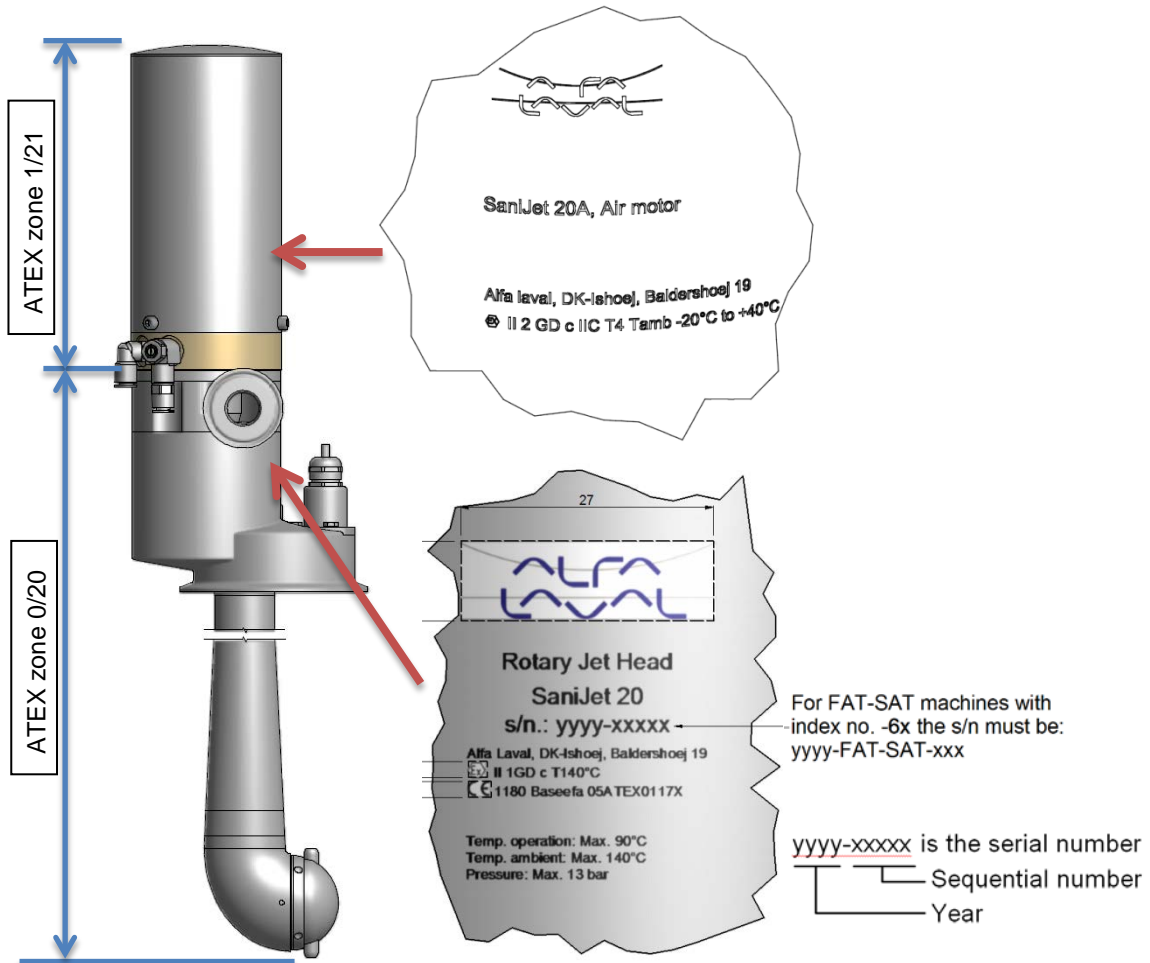

Changes to the machine are not allowed without approval by the person responsible for the ATEX certification at Alfa Laval Tank Equipment A/S. If changes are made – or spare parts other than Alfa Laval original spare parts are used - the EC Type Examination certification (the ATEX Directive) is no longer valid.

Important information: Also see “Maintenance” pages 31 ff regarding special conditions for repair of ATEX certified machines.



General Description

The Toftejorg SaniJet 20 is a tank cleaning machine intended for industrial use in closed tanks for processing storage and transportation. There is a broad range of application areas within pharmaceutical, food and chemical industries.

The Toftejorg SaniJet 20 is a hygienic cleaning device of the rotary jet head type for permanent installation that provides a 360° indexed cleaning pattern. Provided it is installed in an upright position, the Toftejorg SaniJet 20 is completely self-cleaning and self-draining, and it has an integrated self-cleaning down pipe (patent pending). The drive mechanism is located outside the tank or process equipment, leaving a minimum of parts to be submerged into the product. . All product contact surfaces are AISI 316/316L, duplex SAF 2205, Ti Grade 5, Hastelloy C22/C276 stainless steel and USP Class VI and FDA approved polymer materials such as PEEK, E-CTFE, EPDM, Viton and FFKM.

No threads or screws have been used in the product contact areas.

The cleaning device is lubricated by the cleaning media. No oil, grease or other lubricants are used.

The Toftejorg SaniJet 20 is available in media driven or air motor driven versions. The air motor driven versions are equipped with a magnetic clutch providing a leakage-proof transmission and provide an effective drive for low flow machines in rough environments. The air motor has variable speed in order to adjust cleaning intensity. The media version is covered by Instruction Manual IM-TE91A792.

The Toftejorg SaniJet 20 is designed for use in pharmaceutical, biotechnological, food and dairy processing applications. Tanks and vessels between 0.5-30 m³ (130-8,000 US gallons). The design makes the Toftejorg SaniJet 20 especially well suited when processing high viscous, foaming or thixotropic products and in chemical processing applications, where product cross contamination is unacceptable and must be avoided.

For use in explosive hazard zones the media driven and the air motor driven version can be used, provided it is installed according to safety instructions in local regulations.

Quality System

The Toftejorg SaniJet 20 is produced according to Alfa Laval Tank Equipment's ISO 9001 International Standard certified quality system. All parts are made from certified material and all non-metal parts are made from FDA and USP Class VI approved materials.

General Description (continued)

Functioning

Toftejorg SaniJet 20 consists of 3 main parts: The Drive unit with flow inlet and the Base housing placed outside the tank, and inside the tank: the Down pipe with the rotating Outer tube and the Cleaner unit.

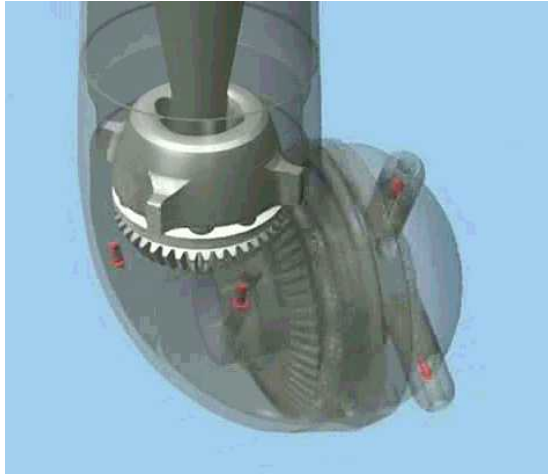

The flow of the cleaning fluid passes from the inlet through the Base housing, through the Down pipe, into the Cleaner head and out through the Nozzles. The Outer tube of the Down pipe is rotably suspended on a Stationary shaft with a Ball bearing inside the Outer tube. The Drive mechanism rotates the Outer tube with the Cleaner unit around the vertical axis. Via a set of Bevel gears on the Stationary shaft and the Cleaner head, the Cleaner head with the Nozzles is simultaneously rotated around the horizontal axis in a fixed relation thus moving the nozzles and the jets 360° around in the tank making a pre-set indexed cleaning pattern

The Toftejorg SaniJet 20 utilises the patented “Golden Section” cleaning pattern. The distance between the tracks of the jets ensures an efficient removal of remaining product from the tank surface right from the beginning of the cleaning sequence, allowing for short cleaning time.

Example – 2 nozzle machine:

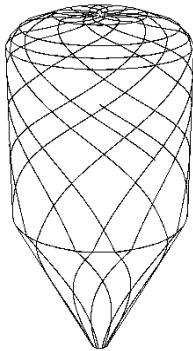

0.8 min.

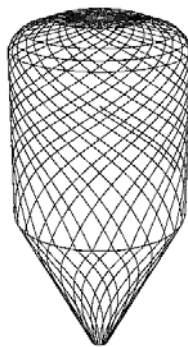

2.3 min.

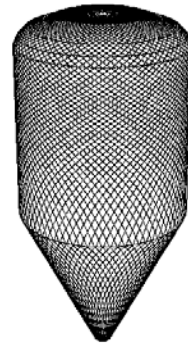

6 min.

The time needed to perform a proper cleaning depends on type of soilage, distance, cleaning procedure and agent. For substances that are easily mobilised, i.e. are easy to remove, less than 1 min. could be sufficient while in cases of more heavy soilage (high viscous, sticky substances, etc.) a more dense pattern/longer time will be needed.

General Description (continued)

Machine with External Motor Drive

The machine is driven by a gear motor mounted on top of the Inlet housing. Via a Magnetic clutch the rotation of the gear motor is transmitted from the outside through a closed wall to the Output shaft placed inside the Inlet housing. The Output shaft is in mesh with the Down pipe and rotates the Down pipe in the same way as in the media driven version.

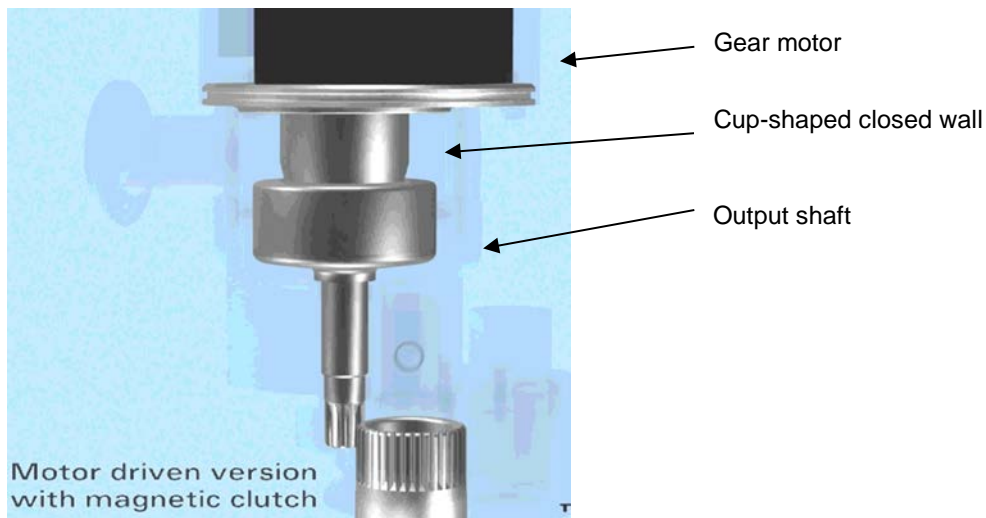

The output shaft of the gear motor is equipped with a Rotor with permanent magnets. The rotor is placed inside the cavity in the Motor flange, made by the cup protruding into the liquid chamber in the Inlet housing. The cup is welded to the motor flange as a hermetic sealed closed wall between the liquid chamber and the outside. The magnetic field from the permanent magnets is transferred through the wall, to a ring with permanent magnets inside the Output shaft, which is placed around the cup on the inside the liquid chamber.

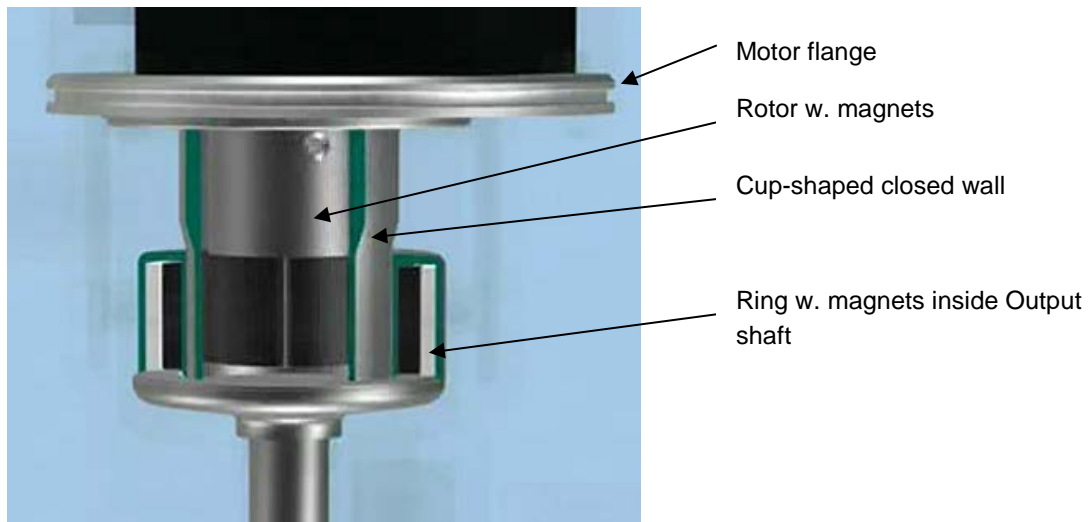

The machine with Air motor is equipped with a flow regulator to make the speed adjustable between approx. 3 and 14 RPM.

General Description (continued)

Self-cleaning

Apart from the main flow flushing the inside of the Base housing and the Down pipe, and thereafter forming the jets through the Nozzles, fluid is flushed through all internal cavities, through Bevel gear, Ball bearings and gabs between moving parts and is finally also used for cleaning of the outside surfaces of the machine. From the gab between the Base housing and the rotating Down pipe, a cleaning jet is directed against the Down pipe, thus loosening and removing product remains on the outside. A liquid film flushing all around the tube further assists by continuously transporting away loosened product remains. The front of the Cleaner head is flushed by a liquid flow from the gab between the Cleaner head and the Retaining ring.

In order to ensure a proper self-cleaning, the machine must be installed in an approx. upright position and the inlet pressure must be min. 3 bar. In the bottom of the Cleaner head, in the Retaining ring, the machine is equipped with a hole to ensure self-draining. This self-draining is only ensured, if the machine is installed in an upright position.

Cleaning Pattern, The Golden Section

The patented Golden Section cleaning pattern (EP-Patent No.: 0495883. US-Patent No.: 5,279.675) is unique in building up the pattern in an ultimate uniform way. The pattern starts very coarse and refines itself in a step-less way by laying out the tracks approximately in the middle between the two most distant tracks already made. This means that the jets always clean the areas containing most remaining product, and thereby remove as much deposit as possible in the shortest possible way.

In case a complete cleaning pattern is not required, it will be possible to reach the same cleaning level within half the time and by using half the amount of cleaning fluid compared to a traditional step-wise cleaning pattern. Furthermore, due to the uniform cleaning pattern, the cleaning can be stopped at any time, whereas with traditional non-uniform cleaning pattern this would not be advantageous. However, after the complete cleaning pattern has been established, the difference between the Golden Section and the traditional stepwise cleaning pattern is negligible.

**Golden Section
Cleaning pattern** **Traditional
Cleaning pattern**

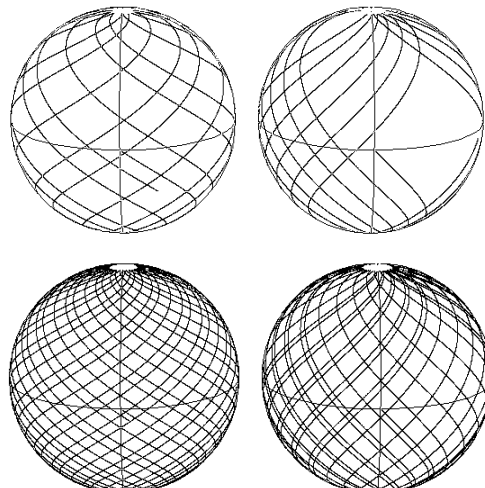

Technical Data

Performance Data for Toftejorg SaniJet 20 Air Driven

Weight of machine	:11.7 kg (25.8 lbs)
Working pressure	: 3-13 bar (45-185 psi)
Recommended media pressure	: 5-8 bar (75-116 psi)
Working temperature (Cleaning unit)	: -20°C to +90°C (-4° to +194°F) (Cleaning fluid and ambient)
Max. temperature inside tank(Cleaning unit)	: 140°C (284°F) (When not operating)
Working ambient temperature (Drive unit)	: -20°C to +40°C (-4°F to +104°F) (Ambient)
Max. air pressure (Drive unit)	: 6 bar (87 psi)
Max. ambient temp. f. air motor	: +40°C (104°F)
Effective throw length	: 1.0-5 m (3-16 ft)
Materials	: Stainless Steel: AISI 304/316/316L, SAF 2205, Ti Grade 5, Hastelloy C22/C276, MS-nickled.
	Sealing: EPDM, Viton, FFKM. FDA 21 CFR §177 and USP Class VI Polymers: PEEK, E-CTFE. FDA-approved 21 CFR §177 and USP Class VI
Surface finish	: Product contact surfaces: Ra=0.8 µm – except weldings
Improved surface finish	: 0.5 µm Ra internal/external media contact parts - 0.8 µm Ra non media contact parts. Note: Certain Exception applies
Lubricant	: Machine Air motor : See page 23

Principal Dimensions in mm, Air driven

Inlet connection: 1" Clamp ISO2852

Tank connection: 4" Clamp ISO2852

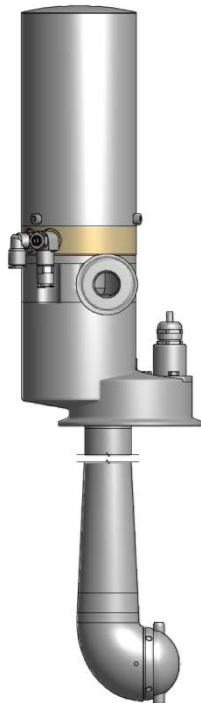

For portable or permanent installation, or installation through long "nozzles", 4" (100 mm) version are recommended.

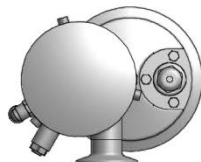
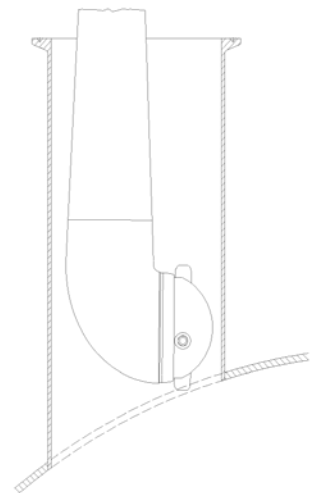

Technical Data (continued)

Inlet connection: 1" Clamp ISO2852

Tank connection: 3" Clamp ISO2852

For permanent installation machine can pass through 3" clamp of max. length 50 mm:

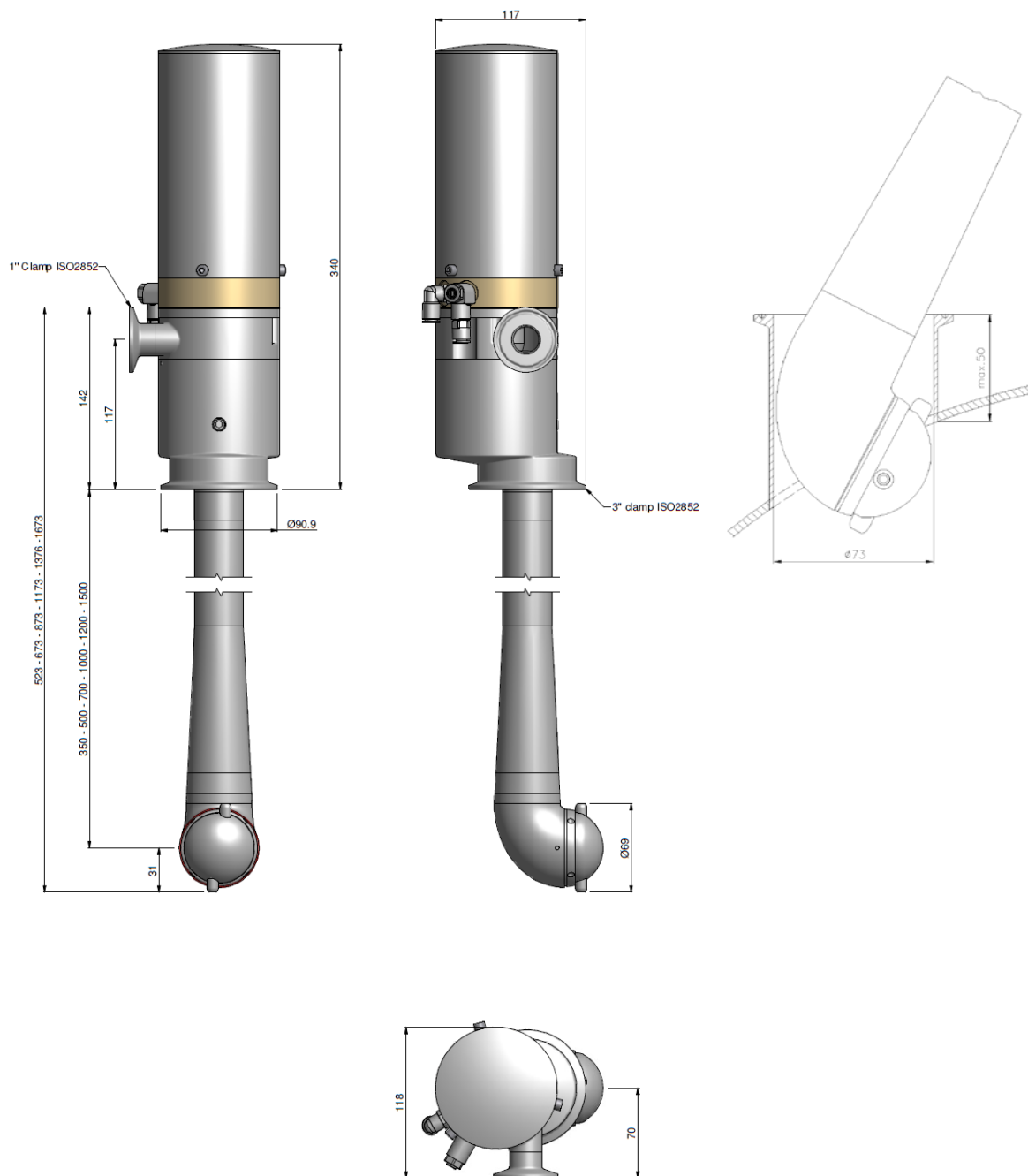

Performance Data for Toftejorg SaniJet 20 Air Driven

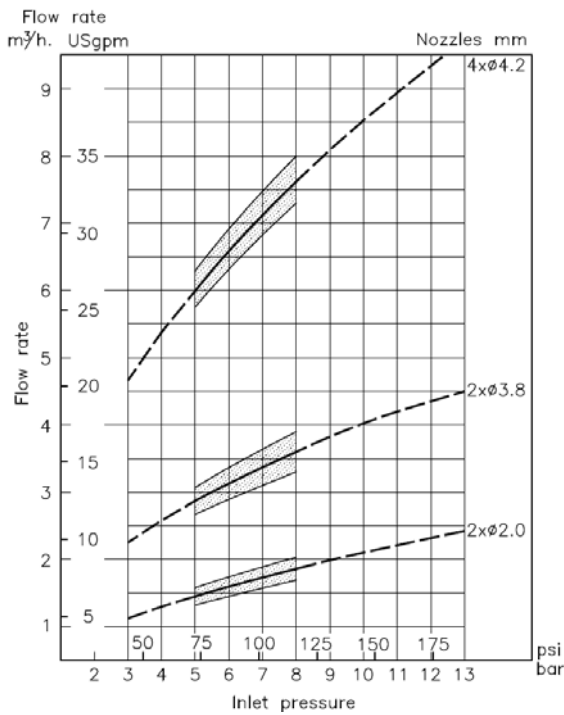

Flow rate

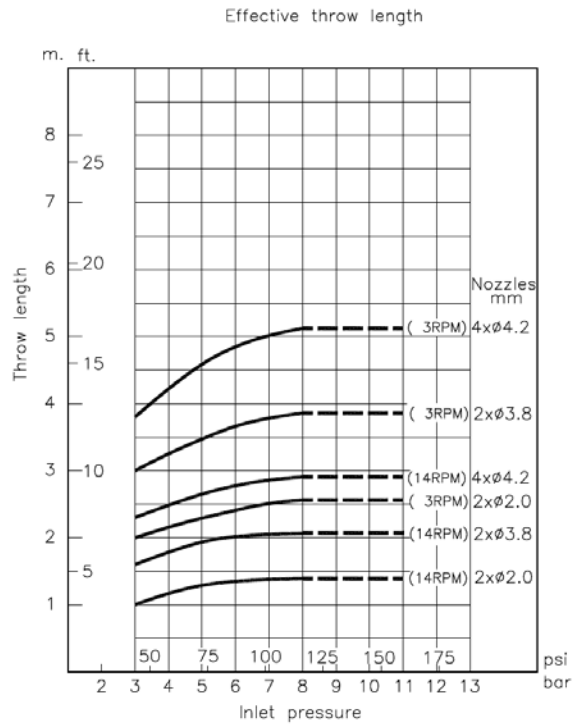

Effective throw length depending on rotation speed

Down pipe RPM	Time between vertical jet impingements		Cleaning time complete pattern
	2 Nozzles	4 Nozzles	
3	3.6 sec.	1.8 sec.	18.4 min
4	2.7 sec.	1.3 sec.	13.8 min
5	8.7 sec.	4.3 sec.	11.0 min
6	7.2 sec.	3.6 sec.	9.2 min
7	6.2 sec.	3.1 sec.	7.9 min
8	5.4 sec.	2.7 sec.	6.9 min
9	4.8 sec.	2.4 sec.	6.1 min
10	4.3 sec.	2.2 sec.	5.5 min
11	3.9 sec.	2.0 sec.	5.0 min
12	3.6 sec.	1.8 sec.	4.6 min
13	3.3 sec.	1.7 sec.	4.2 min
14	3.1 sec.	1.6 sec.	3.9 min

Note: Effective throw length varies depending on jet transverse speed over surface, substance to be removed, cleaning procedure and agent.

The inlet pressure has been taken immediately before the machine inlet. In order to achieve the performance indicated in the curves, the pressure drop in the supply lines between pump and machine must be taken into consideration.

Technical Data (continued)

Performance Data for Toftejorg SaniJet 20 Air Driven

Air supply pressure	:	Max. 6 bar (87 psi)
Air quality	:	Clean, filtered max. 50 µm Dry, dew point max. 5°C
Air consumption at max. speed	:	6 l/sec. (22 m ³ /h) ~ 95 Usgpm
Adjustable speed	:	3-14 RPM
Cleaning time	:	4-18 min (adjustable)

Instruction Manual, Installation

Contents

Contents 18
General Installation Instructions..... 19
Special Conditions for Safe Use in accordance with the ATEX Certification, Directive 94/9/EC 20
Installation of Air Motor 22

Installation

General Installation Instructions

The Toftejorg SaniJet 20 is designed to be installed in a vertical upright position.

It is recommended to install a filter with mesh size 250 µm (0,001") in the supply line in order to avoid particles, scale etc. from clogging inside the machine. It is essential to avoid fine solid particles, such as fine sand, in the cleaning fluid as they will increase wear considerably. This is particular important in case of recirculation.

In order to prevent accidental leakage of cleaning fluid into the tank it is recommended to install a shut-off valve close to the machine inlet. This will also prevent back-flow of liquid from the tank through the machine in case the cleaner head is submerged and there is an over-pressure inside the tank. The installation and operation shall be made in such a way that the draining of the machine is ensured.

It is recommended that the fluid valve fitted is of a type that prevents hydraulic shocks, which may cause severe damage to the entire installation.

Before installation, all supply lines and valves must be thoroughly flushed to remove remains of welding electrodes, grinding dust, scale and other foreign matter.

During handling and installation handle the machine with care in order not to damage the fine surface finish of the machine.

The Toftejorg SaniJet 20 machine has been tested in a test tank according to Alfa Laval Tank Equipment test procedures at the factory before shipping.

Note: Do not try to turn Nozzle head by hand, since this may damage the Gear. Nozzle head can be turned by blowing air from an air pistol through the inlet connection of the media driven machine or the intake port of the air motor.

Note: The machine shall be installed in accordance with national regulations for safety and other relevant regulations and standards. In EU-countries the complete system must fulfil the EU-Machine Directive and depending of application, the EU-Pressure Equipment Directive, the EU-ATEX Directive and other relevant Directives and shall be CE-marked before it is set into operation.

Warning: Precautions shall be made to prevent starting of the cleaning operation, while personnel are inside the tank or otherwise can be hit by jets from the nozzles.



Installation (continued)

Special Conditions for Safe Use in accordance with the ATEX Certification, Directive 94/9/EC

Warning: If the machine is used in potential explosive atmospheres, tapes or joint sealing compounds, which are electrical insulators, must not be used on joints, if this may violate the grounding of the machine to the tank. Resistance between nozzles and tank must not exceed 20.000 Ω . The intended installation with standard clamp connections will ensure this. In addition, connecting pipe work, must be electrically conductive and earthed to the tank structure. This is essential to avoid the build-up of static electricity on the nozzles and the machine. For further information see DS/CLC/TR 50404:2003 Safety of Machinery, guidance and recommendations for the avoidance of hazards due to static electricity.



Warning: The unit may be operated, in a hazardous area, when filled with the process fluid.



If the Cleaner unit is not filled with process fluid the Cleaner unit may be operated / rotated by the Drive unit, in a hazardous area, for one minutes max.

Warning: Working temperature max for **Cleaner unit:**



The maximum permitted process fluid temperature and ambient temperature when the machine is operating is +90°C.

Ambient temperature **Cleaner unit:**

When the Cleaner unit is **not** operating, the maximum permitted ambient temperature is 140°C.

Ambient temperature for **Drive unit:**

The maximum permitted ambient temperature when the Drive unit is operating is +40°C.

Warning: The maximum permitted process fluid pressure is 13 bar(g).



Warning: The unit must not be operated in a vessel having an enclosed volume of greater than 100 m³.



In addition to the above mentioned precautions relating to the ATEX guidelines Directive 94/9/EC of March 23 1994, the general safety precautions in this manual must be observed, see pages 28-29.

Warning: In potentially explosive atmospheres, the temperature must not exceed the maximum surface temperature according to the temperature class for the combustible gas or liquid.



Warning: If the cleaning media is both inflammable and an insulator with high resistance, it must be made electrically conductive by additives or otherwise having a volume resistivity > 104 Ωm but ≤ 109 Ωm.



For further information see DS/CENELEC/TR 50404:2003 §5.3.4 and §2.8.

Warning: In case potentially explosive liquids are used, precautions should be taken against incidental creation of an explosive mixture with oxygen in the tank atmosphere.



Warning: Tanks with capacities greater than 100 m³ that could contain a flammable atmosphere should not be steam cleaned, as steam issuing from a nozzle could contain charged droplets.



Tanks smaller than this may be steam cleaned providing that: the steam nozzles and other metal parts of the system are reliably earthed and grounded to the tank structure.

Warning: In potentially explosive atmospheres, the temperature must not exceed the maximum surface temperature according to the temperature class for the combustible gas or liquid.



Warning: MODEC air motors are designed to be operated by compressed air only. Do not drive with flammable or explosive gases.



Warning: MODEC air motors are designed to be operated by lubricated compressed air. The pneumatic oil used must have a self-ignition temperature above 260°C. The air motor must be lubricated with 50mm³ per m³ of air (1 drop = 15 mm³). The pneumatic oil used must have a viscosity between 22 and 46 cst depending on the temperature of the motor operation (e.g. 40°C the viscosity of the oil shall be between 22 and 30 cst).



In addition to the above mentioned precautions relating to the ATEX guidelines Directive 94/9/EC of March 23 1994, the general safety precautions in this manual must be observed, see pages 28-29.

Installation (continued)

Installation of Air Motor

Important Information

Recommended inlet air pressure is not to exceed 6 bar (87 psi) maximum. It is recommended to use an air filter and moisture trap on inlet air supply to avoid contamination being fed into air motor.

General Information

The air motor is designed to be driven by compressed air and under no circumstances be driven with any other gases. Fluids, particles, solids or any substances mixed with air, particularly combustible substances likely to cause explosions, must not drive air motor.

Danger: Do not drive with flammable or explosive gases.



Caution: Air motor is designed for air only. Do not allow corrosive gases or particulate material to enter motor. Water vapor, oil-based contaminants, or other liquids must be filtered out.



Caution: Do not use a hammer or force coupling or drive pulley onto shaft when installing drive onto air motor. This causes end thrust that could damage air motor.



Note: Ambient temperature outside tank should not exceed +40°C (+104°F).

Installation

Install a moisture trap and filter in air line ahead of motor. For efficiency of output and control of speed, use air lines of same size or in next pipe size larger than intake port of motor. As inlet line a $\varnothing 8/5.5$ tube should be used (customer supply). As standard, the drive unit is fitted with a hose connector $\varnothing 8$ on the blow-out line. It is possible to lead the exhaust out of the room with a hose and it is recommended in this context to use an adapter so that a $\varnothing 12$ tube or larger can be used for this. It is also possible to attach a silencer on the exhaust, but in this respect it should be borne in mind that a possible oil mist may contaminated surroundings in the room where it exhausted.

Installation (continued)

Lubrication

The pneumatic oil used for lubrication must have a self-ignition temperature above 260°C and have a viscosity between 22 and 46 cst depending on the temperature of the motor operation (e.g. 40°C the viscosity of the oil shall be between 22 and 30 cst).

MODEC recommends that an automatic air line lubricator, be installed in air line just ahead of air motor. Lubricator should be adjusted to feed with 50mm³ of oil per m³ of air (1 drop = 15 mm³) (see table below).

At max power		At max speed					
Air cons. (1/min)	Lubrication (drops/min)	Air cons. (1/min)	Lubrication (drops/min)	Valve mini Kv	Max air flow (1/min)	Feeding pipe min. dia. (mm)	Connection min. dia. (mm)
290	1	360	1	20	1293	6	5

Lubrication is necessary for all internal moving parts. Excessive moisture in air line can cause rust formation in motor and might also cause ice to form in muffler due to expansion of air through motor. Moisture problem can be corrected by installing a moisture separator in line and also by installing an after-cooler between compressor and air receiver.

A lubricant filter (FRL) unit should be installed between upstream from the motor. Filtration should be 50 micron maximum.

Mounting

Warning: Beware of any exposed and/or moveable parts. Proper guards should be in place to prevent personal and/or property damage.



Instruction Manual, Operation

Contents

Contents 24

Normal Operation 25

Normal Operation of Air Motor..... 26

Safety Precautions 28

Safety Precautions for Air Motor..... 29

Operation

Normal Operation

Pressure

In order to protect the machine, your pipe and valve installation, etc. against damage:

Avoid hydraulic shocks! Put on pressure gradually!

Recommended working pressure: 5- 8 bar (75 - 116 psi). Too high pressure will increase consumption of wear parts.

The machine is designed to stand up to 13 bar working pressure. This is normally not recommended but may be used for special purposes, where high pressure at close distance is preferred.

Cleaning Media

Use only cleaning fluids, which are compatible with Stainless Steel AISI 316/316L, SAF2205, Titanium Grade 5, Hastelloy C22/C276, PEEK, E-CTFE, EPDM, Viton and FFKM. Please note that PEEK is not resistant to concentrated sulfuric acid. Normal detergents, moderate solutions of acids and alkalis are acceptable as well as a number of solvents at ambient temperature during cleaning. Aggressive chemicals, excessive concentrations of chemicals at elevated temperatures as well as certain solvents and hydrochlorides should be avoided. If you are in doubt, contact your local Alfa Laval Tank Equipment sales office.

Temperature

The machine is designed to operate with cleaning media at temperatures up to 90°C (194 °F). However, it stands temperatures up to 140°C (284°F) inside the tank when it is not operating, and it is possible to steam the tank through the machines.

The machine is not designed to rotate during steaming. The air motor must not be running during steaming.

The machine is designed to operate at an ambient temperatures outside the tank at -20°C to +40°C (-4°F to +104°F). However, it stands ambient temperatures up to 80°C (176°F) outside the tank when it is not operating.

Warning:



In potentially explosive atmospheres please see "Special Conditions for Safe Use – ATEX" page 29.

Operation (continued)

After-Use Cleaning

After use flush the machine with fresh water. Cleaning media should never be allowed to dry or set-up in the system due to possible "salting out" or "scaling" of the cleaning media. If cleaning media contains volatile chloride solvents, it is recommended not to flush with water after use, as this might create hydrochloric acid.

Normal Operation of Air Motor

Never let the machine run dry without cleaning media except for short time under surveillance. It is recommended always to put on pressure with cleaning media before the air motor starts rotating. This will ensure proper cooling and lubrication of the bearings.

Warning:



Do not remove muffler during operation. Solid or liquid material exiting unit can cause eye or skin damage. Keep away from air stream.

Always disconnect air supply before servicing.

Speed adjustment

The air motor provides adjustable rotation speed and makes it possible to optimise the cleaning time and fluid consumption to the actual cleaning job.

High rotation speed may be used in small tanks with easy to clean substances, whereas larger tanks or more difficult cleaning tasks require slower rotation for longer throw length or higher impact and wetting intensity. The correlation between rotation speed, throw length and cleaning time appears from the curves and the table on page 16.

Operation (continued)

The rotation speed is pre-set at the factory to approx. 3 RPM

The rotation speed is adjusted on the Flow regulator (Pos. 66) with a small screwdriver, see photo below.

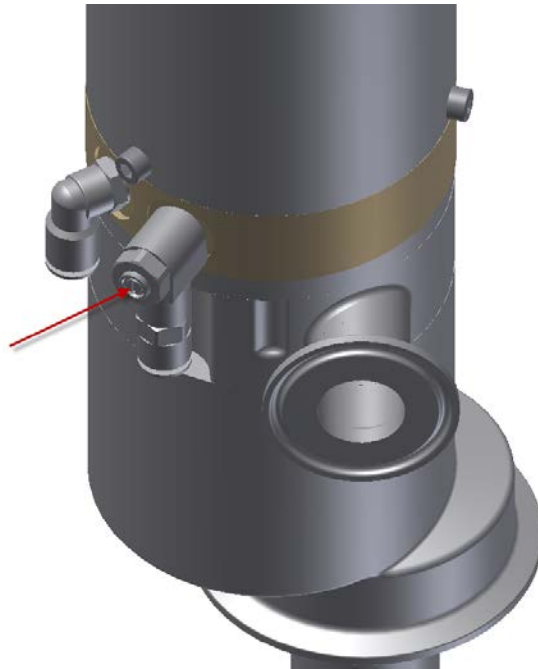

The speed can be approximately adjusted without cleaning media, however when cleaning with media under pressure the rotation speed will be slightly reduced. For fine adjustment the machine should be installed in the tank and run with cleaning media at the stipulated pressure in the closed tank.

To verify the rotation speed: record the time intervals between vertical jet impingements on the tank top. This can easily be detected from the sound pattern of the jets moving over the tank surface. Use the table on page 16 to find time interval for the desired RPM-value.

Caution:



Do not allow air motor to “run free” at high speeds with no loads. Excessive internal heat build-up, loss of internal clearances and rapid motor damage will result.

Operation (continued)

Safety Precautions

The machine is intended for use inside a tank only. As peak velocity of main jets reaches 40 m/s, Toftejorg SaniJet 20 must not be operated in open air or when tank is open.

Warning: Hot chemicals and steam under pressure may be used for cleaning and sterilising. Protect against scalding and burning. Never tamper with or try to open clamps or other connections while system is in operation. Make sure that system is de-pressurised and drained before disassembly.



The cleaning jets impinging the tank surface are a source of noise. Depending on pressure and distance to the tank walls, noise level may reach up to 85 dB.

Warning: In case potentially explosive liquids are used, see “Special Conditions for Safe Use – ATEX” page 29.



Warning: Tanks with capacities greater than 100 m³ that could contain a flammable atmosphere should not be steam cleaned, see “Special Conditions for Safe Use – ATEX” page 29.



Warning: Tanks may contain poisonous/hazardous products or products which represent an environmental or safety risk. Never open tank and dismantle the machine without checking previous tank contents and necessary precautions.



Warning: Retaining screw on side of Base housing (Pos. 17) must never be loosened, when machine is mounted in tank unless down pipe is supported and Pressure line is disconnected, as otherwise the complete Down pipe assembly will fall down.



Warning: To prevent explosive hazard DO NOT drive this air motor with combustible gases. Injury and/or property damage can result.



Operation (continued)

Safety Precautions for Air Motor

Warning: Do not remove muffler during operation. Solid or liquid material exiting unit can cause eye or skin damage. Keep away from air stream.



Always disconnect air supply before servicing.

Warning: Do not use kerosene or other combustible solvents for cleaning the inside of the motor during maintenance.



Instruction Manual, Maintenance

Contents

<u>Contents</u>	30
<u>Preventive Maintenance</u>	31
<u>Reserved rights for design changes of Alfa Laval equipment used in validated processes</u>	31
<u>Service and repair of ATEX approved machines</u>	32
<u>Service and repair of machines ordered with Q-Doc</u>	33
<u>Every 300 working hours</u>	34
<u>Preventive Maintenance of Air Motor</u>	35
<u>Part List Drawing</u>	36
<u>Toftejorg SaniJet 20 Air Driven complete, Part List Drawing</u>	37
<u>Reference List of Parts</u>	38
<u>Toftejorg SaniJet 20A, Air Driven (EPDM as standard)</u>	38
<u>Toftejorg SaniJet 20 Air Driven with improved surface finish (EPDM as standard)</u>	40
<u>Toftejorg SaniJet 20 Air Driven, Hastelloy version (FFKM as standard)</u>	42
<u>Dismantling and reassembling, Cleaner Unit</u>	47
<u>Dismantling and reassembling, Base Unit</u>	48
<u>Air motor Drive unit</u>	50
<u>Rotacheck System</u>	51
<u>Trouble Shooting Guide</u>	52
<u>Service Kits and Tools</u>	54
<u>Service Intervals</u>	54
<u>Service Kit in Viton for Toftejorg SaniJet 20 motor driven version (air/electrically)</u>	54
<u>Service Kit in EPDM for Toftejorg SaniJet 20 motor driven version (air/electrically)</u>	54
<u>Service Kit in Perlast for Toftejorg SaniJet 20 motor driven version (air/electrically)</u>	55
<u>Tools</u>	55
<u>How to Order Spare Parts</u>	56
<u>How to contact Alfa Laval Tank Equipment</u>	56
<u>EU Declaration of Conformity with ATEX Certification</u>	56
<u>Declarations of Conformity per EN 10204 Type 2.2</u>	58

Maintenance

Preventive Maintenance

In order to keep your tank cleaning machine servicing you as an efficient tool in your tank cleaning operations, it is essential to maintain its high performance by following a simple preventive maintenance programme.

Good maintenance is careful and regular attention!

The following recommended preventive maintenance is based on tank cleaning machines working in average conditions. However, you will appreciate that a tank cleaning machine, which has a rough and dirty job to do, will need more frequent attention than one working in ideal conditions. We trust that you will adjust your maintenance programme to suit.

Handle machine with care. Take proper action to protect fine surfaces from being damaged.

Always use only proper tools. Use Toftejorg SaniJet 20 standard tool kit. Never force, hammer or pry components together or apart. Always perform all assembly/disassembly steps in the order described in this manual.

Never assemble components without previous cleaning. This is especially important at all mating surfaces.

Work in a clear well-lighted work area.

Reserved rights for design changes of Alfa Laval equipment used in validated processes

Alfa Laval is continuously working on improving our equipment and services. In this improvement work Alfa Laval may for example change the design and material in our equipment. A change in the design will not necessarily entail a change of the specification and item no. for the equipment.

Alfa Laval reserves the right to change the design of Alfa Laval equipment without any notifications for improvements of our design.

If Equipment from Alfa Laval is used in connection with, for example, a validated plant, and an order for replacements is made, the design of the replacement may have been changed even if the specifications /item no. is the same as the existing installed and validated ones.

When ordering a replacement please contact Alfa Laval sales support in this matter before placing the order.

Service and repair of ATEX approved machines

In order to ensure compliance with the ATEX regulations for service and repair in accordance with EN 60079-19, all service and repair of ATEX approved machines should be performed by Alfa Laval Tank Equipment, Kolding, Denmark or by an Alfa Laval service center approved by Alfa Laval Tank Equipment.

Warning: ATEX requirements regarding repair of ATEX approved machines according to EN 60079-19



A tag with the following labelling information must be attached to the machine:

- Repair symbol 
- Alfa Laval logo and address
- Repair number
- Date of repair
- Machine serial number

The tag must be laminated and attached to the machine using a cable tie.

If a customer wishes to carry out service or repair himself, it is the responsibility of the repair shop to ensure that the ATEX requirements are met in any way possible. After performing service or repair, the repair shop thus carries the full responsibility for the ATEX approval of the machine.

Maintenance (continued)

Service and repair of machines ordered with Q-Doc

In order to ensure full traceability and to obtain full qualification and validation documentation, all service and repair of machines ordered with Q-Doc (Qualification Documentation) should be handled and ordered in one of the 2 different ways described below:

1. **Q-Doc+FAT-SAT Service/Repair Order** (Item no.: TEREQ-Q-doc):

(This maintenance order should be selected if the customer wishes to have Alfa Laval Tank Equipment to obtain full file log of all FAT (Factory Acceptance Test) documents for the Tank Cleaning Machine).

- Maintenance/Repair is carried out at Alfa Laval Tank Equipment and Q-Doc Maintenance Log, FAT-SURFACE (if necessary), FAT-WELD (if necessary) and FAT-PERFORMANCE is performed. The FAT documents are stored in the Q-Doc Maintenance Log as PDF-files.
- 3.1 Certificate + FDA and USP Class VI Declaration of Compliance for all spare parts are stored in the Q-Doc Maintenance Log as PDF-files.
- The machine is returned to the customer incl. the Q-Doc-Log CD and hardcopy of all FAT documents, for further qualification (SAT: Site Acceptance Test) and validation (PV: Process Validation).
- Word and PDF documents are stored in the Alfa Laval Q-Doc Maintenance Log folder.

2. **Q-Doc+FAT-SAT Spare Part Order** (Item no.: TE24XXXX-5X or -6X)

(This maintenance order should be selected if the customer wishes to carry out service or repair. The customer or the repair shop thus carries the full responsibility for the full traceability of the material and FAT documentation for the Tank Cleaning Machine).

- The spare part is sent to the customer incl. 3.1 Cert. + FDA and USP Class VI Declaration of Compliance incl. Weld-Log documentation (Inner shaft, Outer pipe) as hardcopy.
- This service information will not be recorded in the Alfa Laval Q-Doc folder. The customer has to perform all Qualification tests and documentation (FAT, SAT, IQ & OQ) himself.

Contact local Alfa Laval service and support (see. www.alfalaval.com).

Important information to give to Alfa Laval:

- Serial No.
- Q-Doc+FAT-SAT maintenance order type:
 - Item no.: TEREQ-Q-doc
 - or
 - Item no.: 24XXXX-5X or -6X(See page 46 for more information)

Maintenance (continued)

Every 300 working hours

1. Disassemble machine as described on the following pages.
2. Clean material build-up and deposits from internal parts with water or suitable chemical cleaner, possibly Scotch-brite, S-Ultrafine.
3. Check Bearing bushes (Pos. 20 + 19) in Base housing by fitting Rotor outer (Pos. 60) and check sideways movement. Replace if necessary. If bushes are worn they will allow Rotor outer to tilt and eventually it may seize up.

Note: Timely replacement of bearings will prevent costly damage to the gear. However, all Bearing bushes, made from high performance plastic PEEK-material, are mounted with press-fit and should not be removed unless they need to be replaced.

4. Check unrestricted rotation of Ball bearings. Inspect for build-up of foreign material in Ball rings (Pos. 10 + 4) and Ball races. Balls must rotate freely in Ball rings.

Assemble machines as described in the following pages.

5. After fitting the Rotor outer (Pos. 60), before mounting Motor drive unit, rotate down pipe and check unrestricted rotation.
6. Also check unrestricted rotation of Motor drive unit before mounting on machine.

In order to ensure current good hygiene it is recommended to replace all rubber seals at each service inspection.

Apart from the parts specifically mentioned above, all the remaining wear parts should regularly be inspected for wear. Wear parts are specified in the Reference Lists of Parts, pages 38-43.

Maintenance (continued)

Preventive Maintenance of Air Motor

General recommendation

- Air motor maintenance shall be performed by skilled operators, trained by MODEC or by our after sales service department.
- It is advisable to check and clean air motors every six months when used daily.
- In case of engine malfunction after a period of inactivity, insert a few oil drops into the air supply pipe.
- Always Unplug motor feeding connection before starting an operation of substitution, adjustment, maintenance or dismantling.
- After each maintenance operation, motors should be tested to check proper operation.
- Use only original replacement parts and elements for maintenance, lubrication and sealing.

Your motor has been delivery with permanent greasing, if required the reducer can be re-greased:

- old grease must be removed carefully

- 50 to 70mL of grease 606 ORAPI CTDMEP 2 has to be distribute uniformly inside the reducer

Quick diagnosis

Symptoms	Causes	Actions
rotation of the output shaft	<ol style="list-style-type: none">1. Insufficient air supply2. Too much load on the shaft3. Wrong seizing of internal components of motor4. Blades blocked	<ol style="list-style-type: none">1. Check the air source2. Check the air connection3. Check the load4. Pulse air in the inlet
Insufficient power, speed or torque	<ol style="list-style-type: none">1. Lack of pressure2. Lack of flow3. Outlet counter-pressure	<ol style="list-style-type: none">1. Check pressure2. Check flow3. Check that the muffler is adequate and properly fitted
Wrong rotation direction	<ol style="list-style-type: none">1. Wrong hose connection	<ol style="list-style-type: none">1. Reverse input and output2. Check the air connection

- If after all checks listed in this manual your motor is not working properly, please contact the "MODEC After Sales Services". www.modec.fr

Shutdown procedure

1. Turn off air intake supply and remove plumbing.
2. Remove air motor from connecting machinery.
3. Use clean, dry air at low pressure to “flush out” condensates, such as water.

Warning: Solid or liquid material exiting unit can cause eye or skin damage. Keep away from air stream.



4. Re-lubricate air motor with a squirt of oil in chamber. Rotate shaft by hand several times.
5. Plug or cap each port.

Unit is ready for storage.

Part List Drawing

Toftejorg SaniJet 20 Air Driven complete, Part List Drawing

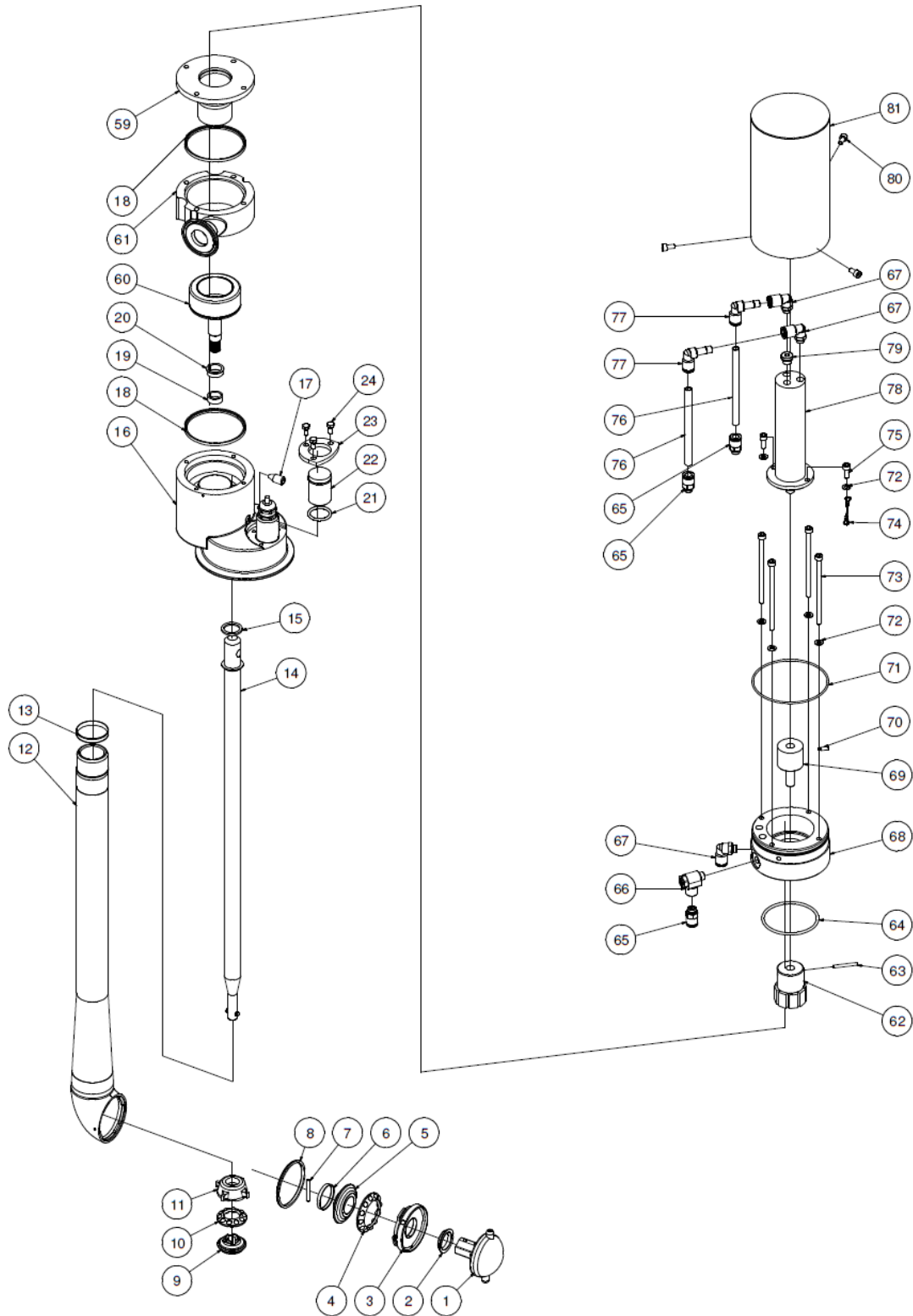

Reference List of Parts

Toftejorg SaniJet 20A, Air Driven (EPDM as standard)

Pos		Item no. for 4" version	Item no. for 3" version	No/ Unit	Description	Material	Remarks
1	<input type="checkbox"/>	TE20B334	TE20B334	1	Cleaner head 2xø2.0mm	Stainless steel	Spare part
	<input type="checkbox"/>	TE20B335	TE20B335	1	Cleaner head 2xø3.8mm	Stainless steel	Spare part
	<input type="checkbox"/>	TE20B336	TE20B336	1	Cleaner head 4xø4.2mm	Stainless steel	Spare part
2		TE20B554	TE20B554	1	Bearing bush	Polymer	Wear part
3		TE20B552	TE20B552	1	Retaining ring	Stainless steel	Wear part
4		TE20B365	TE20B365	1	Ball ring N	Polymer/Titanium	Wear part
5		TE20B550	TE20B550	1	Bevel gear	Stainless steel	Wear part
6		TE20B571	TE20B571	1	Clip ring	Stainless steel	Spare part
7		TE20B572	TE20B572	1	Pin	Stainless steel	Spare part
8	<input type="checkbox"/>	TE20B553	TE20B553	1	Seal ring H	EPDM	Wear part
	<input type="checkbox"/>	TE20B553-01	TE20B553-01	1	Seal ring H	FPM (Viton)	Wear part
	<input type="checkbox"/>	TE20C553	TE20C553	1	Seal ring H	FFKM	Wear part
9		TE20B542	TE20B542	1	Bevel gear	Stainless steel	Wear part
10		TE20B364	TE20B364	1	Ball ring	Polymer/Titanium	Wear part
11		TE20B539	TE20B539	1	Ball race	Stainless steel	Wear part
12	<input type="checkbox"/>	TE20B310	TE20B310	1	Outer tube, L = 350 mm	Stainless steel	Spare part
	<input type="checkbox"/>	TE20B311	TE20B311	1	Outer tube, L = 500 mm	Stainless steel	Spare part
	<input type="checkbox"/>	TE20B312	TE20B312	1	Outer tube, L = 700 mm	Stainless steel	Spare part
	<input type="checkbox"/>	TE20B313	TE20B313	1	Outer tube, L = 1000 mm	Stainless steel	Spare part
	<input type="checkbox"/>	TE20B314	TE20B314	1	Outer tube, L = 1200 mm	Stainless steel	Spare part
	<input type="checkbox"/>	TE20B315	TE20B315	1	Outer tube, L = 1500 mm	Stainless steel	Spare part
13		TE20B510	TE20B510	1	Bearing ring	Polymer	Wear part
14	<input type="checkbox"/>	TE20B538	TE20B538	1	Inner shaft, L = 350 mm	Stainless steel	Spare part
	<input type="checkbox"/>	TE20B532	TE20B532	1	Inner shaft, L = 500 mm	Stainless steel	Spare part
	<input type="checkbox"/>	TE20B533	TE20B533	1	Inner shaft, L = 700 mm	Stainless steel	Spare part
	<input type="checkbox"/>	TE20B534	TE20B534	1	Inner shaft, L = 1000 mm	Stainless steel	Spare part
	<input type="checkbox"/>	TE20B535	TE20B535	1	Inner shaft, L = 1200 mm	Stainless steel	Spare part
	<input type="checkbox"/>	TE20B536	TE20B536	1	Inner shaft, L = 1500 mm	Stainless steel	Spare part
15	<input type="checkbox"/>	TE20B511	TE20B511	1	Plain seal	EPDM	Wear part
	<input type="checkbox"/>	TE20B511-01	TE20B511-01	1	Plain seal	FPM (Viton)	Wear part
	<input type="checkbox"/>	TE20C511	TE20C511	1	Plain seal	FFKM	Wear part
16		TE24G500	TE24B500	1	Base housing	Stainless steel	Spare part
17		TE20B512	TE20B512	1	Retaining screw	Stainless steel	Spare part
18	<input type="checkbox"/>	TE20B516	TE20B516	2	Gasket	EPDM	Wear part
	<input type="checkbox"/>	TE20B516-01	TE20B516-01	2	Gasket	FPM (Viton)	Wear part
	<input type="checkbox"/>	TE20C516	TE20C516	2	Gasket	FFKM	Wear part
19		TE20B514	TE20B514	1	Bearing bush	Polymer	Wear part

Configuration as delivered marked

Please note that some of the polymer parts are in PEEK, which is not resistant to concentrated sulfuric acid.

Available add-on's

Available add-on's regarding material certificates, Declaration of Conformity and Q-Doc documents, see page 46 for more information.

Reference Lists of Parts (continued)

Toftejorg SaniJet 20A, Air Driven (EPDM as standard)

Pos	Item no. for 4" version	Item no. for 3" version	No/ Unit	Description	Material	Remarks
20	TE20B513	TE20B513	1	Bearing bush	Polymer	Wear part
21	<input type="checkbox"/> TE51T127		1	O-ring	EPDM	Wear part
	<input type="checkbox"/> TE51T008		1	O-ring	FPM (Viton)	Wear part
	<input type="checkbox"/> TE51T129		1	O-ring	FFKM	Wear part
22	TE20B642		1	Plug	Stainless steel	Spare part
23	TE24G594		1	Bracket	Stainless steel	Spare part
24	TE51A172		3	Screw	Stainless steel	Spare part
59	TE24B349	TE24B349	1	Motor flange welded A	Stainless steel	Spare part
60	TE20B340	TE20B340	1	Rotor outer complete	Stainless steel/steel	Spare part
61	TE24B351	TE24B351	1	Inlet housing 1" Tri-clamp	Stainless steel	Spare part
62	TE20B343	TE20B343	1	Rotor inner w. magnets	Steel	Spare part
63	TE51C052	TE51C052	1	Tubular rivet	Stainless steel	Spare part
64	TE51T142	TE51T142	1	O-ring	Elastomer	Spare part
65	TE51U392	TE51U392	3	Straight connector	Brass, Nickel-pl.	Spare part
66	TE51U395	TE51U395	1	Flow control valve	Brass, Nickel-pl.	Spare part
67	TE51U393	TE51U393	3	L-connector	Brass, Nickel-pl.	Spare part
68	TE24B557	TE24B557	1	Flange for air motor	Polymer	Spare part
69	TE24B556	TE24B556	1	Adapter for air motor	Polymer	Spare part
70	TE51A096	TE51A096	1	Screw	Stainless steel	Spare part
71	TE51T143	TE51T143	1	O-ring	Elastomer	Spare part
72	TE51B013	TE51B013	6	Washer	Stainless steel	Spare part
73	TE51A097	TE51A097	4	Screw	Stainless steel	Spare part
74	TE24B353	TE24B353	1	Wire for grounding	Stainless steel/alu.	Spare part
75	TE51A112	TE51A112	2	Screw	Stainless steel	Spare part
76	TE51U397	TE51U397	2	Air tubing	Polymer	Spare part
77	TE51U394	TE51U394	2	L-connector	Brass, Nickel-pl.	Spare part
78	TE51U009	TE51U009	1	Air motor		Spare part
79	TE51U396	TE51U396	1	Plug	Brass, Nickel-pl.	Spare part
80	TE51A100	TE51A100	3	Screw	Stainless steel	Spare part
81	TE24B348	TE24B348	1	Motor cover	Stainless steel	Spare part

Configuration as delivered marked

Please note that some of the polymer parts are in PEEK, which is not resistant to concentrated sulfuric acid.

Available add-on's

Available add-on's regarding material certificates, Declaration of Conformity and Q-Doc documents, see page 46 for more information.

Reference List of Parts (continued)

Toftejorg SaniJet 20 Air Driven with improved surface finish (EPDM as standard)

Pos		Item no. for 4" version	Item no. for 3" version	No/ Unit	Description	Material	Remarks
1	<input type="checkbox"/>	TE20E334	TE20E334	1	Cleaner head 2xø2.0mm	Stainless steel	Spare part
	<input type="checkbox"/>	TE20E335	TE20E335	1	Cleaner head 2xø3.8mm	Stainless steel	Spare part
	<input type="checkbox"/>	TE20E336	TE20E336	1	Cleaner head 4xø4.2mm	Stainless steel	Spare part
2		TE20B554	TE20B554	1	Bearing bush	Polymer	Wear part
3		TE20E552	TE20E552	1	Retaining ring	Stainless steel	Wear part
4		TE20B365	TE20B365	1	Ball ring N	Polymer/Titanium	Wear part
5		TE20E550	TE20E550	1	Bevel gear	Stainless steel	Wear part
6		TE20E571	TE20E571	1	Clip ring	Stainless steel	Spare part
7		TE20E572	TE20E572	1	Pin	Stainless steel	Spare part
8	<input type="checkbox"/>	TE20B553	TE20B553	1	Seal ring H	EPDM	Wear part
	<input type="checkbox"/>	TE20B553-01	TE20B553-01	1	Seal ring H	FPM (Viton)	Wear part
	<input type="checkbox"/>	TE20C553	TE20C553	1	Seal ring H	FFKM	Wear part
9		TE20E542	TE20E542	1	Bevel gear	Stainless steel	Wear part
10		TE20B364	TE20B364	1	Ball ring	Polymer/Titanium	Wear part
11		TE20E539	TE20E539	1	Ball race	Stainless steel	Wear part
12	<input type="checkbox"/>	TE20E310	TE20E310	1	Outer tube, L = 350 mm	Stainless steel	Spare part
	<input type="checkbox"/>	TE20E311	TE20E311	1	Outer tube, L = 500 mm	Stainless steel	Spare part
	<input type="checkbox"/>	TE20E312	TE20E312	1	Outer tube, L = 700 mm	Stainless steel	Spare part
	<input type="checkbox"/>	TE20E313	TE20E313	1	Outer tube, L = 1000 mm	Stainless steel	Spare part
	<input type="checkbox"/>	TE20E314	TE20E314	1	Outer tube, L = 1200 mm	Stainless steel	Spare part
	<input type="checkbox"/>	TE20E315	TE20E315	1	Outer tube, L = 1500 mm	Stainless steel	Spare part
13		TE20B510	TE20B510	1	Bearing ring	Polymer	Wear part
14	<input type="checkbox"/>	TE20E538	TE20E538	1	Inner shaft, L = 350 mm	Stainless steel	Spare part
	<input type="checkbox"/>	TE20E532	TE20E532	1	Inner shaft, L = 500 mm	Stainless steel	Spare part
	<input type="checkbox"/>	TE20E533	TE20E533	1	Inner shaft, L = 700 mm	Stainless steel	Spare part
	<input type="checkbox"/>	TE20E534	TE20E534	1	Inner shaft, L = 1000 mm	Stainless steel	Spare part
	<input type="checkbox"/>	TE20E535	TE20E535	1	Inner shaft, L = 1200 mm	Stainless steel	Spare part
	<input type="checkbox"/>	TE20E536	TE20E536	1	Inner shaft, L = 1500 mm	Stainless steel	Spare part
15	<input type="checkbox"/>	TE20B511	TE20B511	1	Plain seal	EPDM	Wear part
	<input type="checkbox"/>	TE20B511-01	TE20B511-01	1	Plain seal	FPM (Viton)	Wear part
	<input type="checkbox"/>	TE20C511	TE20C511	1	Plain seal	FFKM	Wear part
16		TE24F500	TE24E500	1	Base housing	Stainless steel	Spare part
17		TE20B512	TE20B512	1	Retaining screw	Stainless steel	Spare part
18	<input type="checkbox"/>	TE20B516	TE20B516	2	Gasket	EPDM	Wear part
	<input type="checkbox"/>	TE20B516-01	TE20B516-01	2	Gasket	FPM (Viton)	Wear part
	<input type="checkbox"/>	TE20C516	TE20C516	2	Gasket	FFKM	Wear part
19		TE20B514	TE20B514	1	Bearing bush	Polymer	Wear part

Configuration as delivered marked

Please note that some of the polymer parts are in PEEK, which is not resistant to concentrated sulfuric acid.

Available add-on's

Available add-on's regarding material certificates, Declaration of Conformity and Q-Doc documents, see page 46 for more information.

Reference List of Parts (continued)

Toftejorg SaniJet 20 Air Driven with improved surface finish (EPDM as standard)

Pos	Item no. for 4" version	Item no. for 3" version	No/ Unit	Description	Material	Remarks
20	TE20B513	TE20B513	1	Bearing bush	Polymer	Wear part
21	<input type="checkbox"/> TE51T127		1	O-ring	EPDM	Wear part
	<input type="checkbox"/> TE51T008		1	O-ring	FPM (Viton)	Wear part
	<input type="checkbox"/> TE51T129		1	O-ring	FFKM	Wear part
22	TE20E642		1	Plug	Stainless steel	Spare part
23	TE24F594		1	Bracket	Stainless steel	Spare part
24	TE20E654		3	Screw	Stainless steel	Spare part
59	TE24E346	TE24E346	1	Motor flange welded A	Stainless steel	Spare part
60	TE20E340	TE20E340	1	Rotor outer complete	Stainless steel/steel	Spare part
61	TE24E351	TE24E351	1	Inlet housing 1" Tri-clamp	Stainless steel	Spare part
62	TE20B343	TE20B343	1	Rotor inner w. magnets	Steel	Spare part
63	TE51C052	TE51C052	1	Tubular rivet	Stainless steel	Spare part
64	TE51T142	TE51T142	1	O-ring	Elastomer	Spare part
65	TE51U392	TE51U392	3	Straight connector	Brass, Nickel-pl.	Spare part
66	TE51U395	TE51U395	1	Flow control valve	Brass, Nickel-pl.	Spare part
67	TE51U393	TE51U393	3	L-connector	Brass, Nickel-pl.	Spare part
68	TE24B557	TE24B557	1	Flange for air motor	Polymer	Spare part
69	TE24B556	TE24B556	1	Adapter for air motor	Polymer	Spare part
70	TE51A096	TE51A096	1	Screw	Stainless steel	Spare part
71	TE51T143	TE51T143	1	O-ring	Elastomer	Spare part
72	TE51B013	TE51B013	6	Washer	Stainless steel	Spare part
73	TE51A097	TE51A097	4	Screw	Stainless steel	Spare part
74	TE24B353	TE24B353	1	Wire for grounding	Stainless steel/alu.	Spare part
75	TE51A112	TE51A112	2	Screw	Stainless steel	Spare part
76	TE51U397	TE51U397	2	Air tubing	Polymer	Spare part
77	TE51U394	TE51U394	2	L-connector	Brass, Nickel-pl.	Spare part
78	TE51U009	TE51U009	1	Air motor		Spare part
79	TE51U396	TE51U396	1	Plug	Brass, Nickel-pl.	Spare part
80	TE51A100	TE51A100	3	Screw	Stainless steel	Spare part
81	TE24B348	TE24B348	1	Motor cover	Stainless steel	Spare part

Configuration as delivered marked

Please note that some of the polymer parts are in PEEK, which is not resistant to concentrated sulfuric acid.

Available add-on's

Available add-on's regarding material certificates, Declaration of Conformity and Q-Doc documents, see page 46 for more information.

Reference List of Parts (continued)

Toftejorg SaniJet 20 Air Driven, Hastelloy version (FFKM as standard)

Pos	Item no. for 4" version	Item no. for 3" version	No/ Unit	Description	Material	Remarks
1	<input type="checkbox"/> TE20C334	TE20C334	1	Cleaner head 2xø2.0mm	Alloy	Spare part
	<input type="checkbox"/> TE20C335	TE20C335	1	Cleaner head 2xø3.8mm	Alloy	Spare part
	<input type="checkbox"/> TE20C336	TE20C336	1	Cleaner head 4xø4.2mm	Alloy	Spare part
2	TE20B554	TE20B554	1	Bearing bush	Polymer	Wear part
3	TE20C552	TE20C552	1	Retaining ring	Alloy	Wear part
4	TE20C361	TE20C361	1	Ball ring N	Polymer/Titanium	Wear part
5	TE20C550	TE20C550	1	Bevel gear	Alloy	Wear part
6	TE20C571	TE20C571	1	Clip ring	Alloy	Spare part
7	TE20C655	TE20C655	1	Pin	Alloy	Spare part
8	TE20C553	TE20C553	1	Seal ring H	FFKM	Wear part
9	TE20C542	TE20C542	1	Bevel gear	Alloy	Wear part
10	TE20C360	TE20C360	1	Ball ring	Polymer/Titanium	Wear part
11	TE20C539	TE20C539	1	Ball race	Alloy	Wear part
12	<input type="checkbox"/> TE20C310	TE20C310	1	Outer tube, L = 350 mm	Alloy	Spare part
	<input type="checkbox"/> TE20C311	TE20C311	1	Outer tube, L = 500 mm	Alloy	Spare part
	<input type="checkbox"/> TE20C312	TE20C312	1	Outer tube, L = 700 mm	Alloy	Spare part
	<input type="checkbox"/> TE20C313	TE20C313	1	Outer tube, L = 1000 mm	Alloy	Spare part
	<input type="checkbox"/> TE20C314	TE20C314	1	Outer tube, L = 1200 mm	Alloy	Spare part
	<input type="checkbox"/> TE20C315	TE20C315	1	Outer tube, L = 1500 mm	Alloy	Spare part
13	TE20B510	TE20B510	1	Bearing ring	Polymer	Wear part
14	<input type="checkbox"/> TE20C538	TE20C538	1	Inner shaft, L = 350 mm	Alloy	Spare part
	<input type="checkbox"/> TE20C532	TE20C532	1	Inner shaft, L = 500 mm	Alloy	Spare part
	<input type="checkbox"/> TE20C533	TE20C533	1	Inner shaft, L = 700 mm	Alloy	Spare part
	<input type="checkbox"/> TE20C534	TE20C534	1	Inner shaft, L = 1000 mm	Alloy	Spare part
	<input type="checkbox"/> TE20C535	TE20C535	1	Inner shaft, L = 1200 mm	Alloy	Spare part
	<input type="checkbox"/> TE20C536	TE20C536	1	Inner shaft, L = 1500 mm	Alloy	Spare part
15	TE20C511	TE20C511	1	Plain seal	FFKM	Wear part
16	TE24H500	TE24C500	1	Base housing	Alloy	Spare part
17	TE20B512	TE20B512	1	Retaining screw	Stainless steel	Spare part
18	TE20C516	TE20C516	2	Gasket	FFKM	Wear part
19	TE20B514	TE20B514	1	Bearing bush	Polymer	Wear part

Configuration as delivered marked

Please note that some of the polymer parts are in PEEK, which is not resistant to concentrated sulfuric acid.

Available add-on's

Available add-on's regarding material certificates, Declaration of Conformity and Q-Doc documents, see page 46 for more information.

Reference List of Parts (continued)

Toftejorg SaniJet 20 Air Driven, Hastelloy version (FFKM as standard)

Pos	Item no. for 4" version	Item no. for 3" version	No/ Unit	Description	Material	Remarks
20	TE20B513	TE20B513	1	Bearing bush	Polymer	Wear part
21	TE51T129		1	O-ring	FFKM	Wear part
22	TE20C642		1	Plug	Alloy	Spare part
23	TE24G594		1	Bracket	Stainless steel	Spare part
24	TE51A172		3	Screw	Stainless steel	Spare part
59	TE24C346	TE24C346		Motor flange welded A	Alloy	Spare part
60	TE20C340	TE20C340	1	Rotor outer complete	Alloy	Spare part
61	TE24C351	TE24C351	1	Inlet housing 1" Tri-clamp	Alloy	Spare part
62	TE20B343	TE20B343	1	Rotor inner w. magnets	Steel	Spare part
63	TE51C052	TE51C052	1	Tubular rivet	Stainless steel	Spare part
64	TE51T142	TE51T142	1	O-ring	Elastomer	Spare part
65	TE51U392	TE51U392	3	Straight connector	Brass, Nickel-pl.	Spare part
66	TE51U395	TE51U395	1	Flow control valve	Brass, Nickel-pl.	Spare part
67	TE51U393	TE51U393	3	L-connector	Brass, Nickel-pl.	Spare part
68	TE24B557	TE24B557	1	Flange for air motor	Polymer	Spare part
69	TE24B556	TE24B556	1	Adapter for air motor	Polymer	Spare part
70	TE51A096	TE51A096	1	Screw	Stainless steel	Spare part
71	TE51T143	TE51T143	1	O-ring	Elastomer	Spare part
72	TE51B013	TE51B013	6	Washer	Stainless steel	Spare part
73	TE51A097	TE51A097	4	Screw	Stainless steel	Spare part
74	TE24B353	TE24B353	1	Wire for grounding	Stainless steel/alu.	Spare part
75	TE51A112	TE51A112	2	Screw	Stainless steel	Spare part
76	TE51U397	TE51U397	2	Air tubing	Polymer	Spare part
77	TE51U394	TE51U394	2	L-connector	Brass, Nickel-pl.	Spare part
78	TE51U009	TE51U009	1	Air motor		Spare part
79	TE51U396	TE51U396	1	Plug	Brass, Nickel-pl.	Spare part
80	TE51A100	TE51A100	3	Screw	Stainless steel	Spare part
81	TE24B348	TE24B348	1	Motor cover	Stainless steel	Spare part

Configuration as delivered marked

Please note that some of the polymer parts are in PEEK, which is not resistant to concentrated sulfuric acid.

Available add-on's

Available add-on's regarding material certificates, Declaration of Conformity and Q-Doc documents, see page 46 for more information.

Reference List of Parts (continued)

Toftejorg SaniJet 20 Air Driven, Hastelloy version with improved surface finish (FFKM as standard)

Pos	Item no. for 4" version	Item no. for 3" version	No/ Unit	Description	Material	Remarks
1	<input type="checkbox"/> TE24J334	TE24J334	1	Cleaner head 2xø2.0mm	Alloy	Spare part
	<input type="checkbox"/> TE24J335	TE24J335	1	Cleaner head 2xø3.8mm	Alloy	Spare part
	<input type="checkbox"/> TE24J336	TE24J336	1	Cleaner head 4xø4.2mm	Alloy	Spare part
2	TE20B554	TE20B554	1	Bearing bush	Polymer	Wear part
3	TE24J552	TE24J552	1	Retaining ring	Alloy	Wear part
4	TE20C361	TE20C361	1	Ball ring N	Polymer/Titanium	Wear part
5	TE24J550	TE24J550	1	Bevel gear	Alloy	Wear part
6	TE24J571	TE24J571	1	Clip ring	Alloy	Spare part
7	TE24J655	TE24J655	1	Pin	Alloy	Spare part
8	TE20C553	TE20C553	1	Seal ring H	FFKM	Wear part
9	TE24J542	TE24J542	1	Bevel gear	Alloy	Wear part
10	TE20C360	TE20C360	1	Ball ring	Polymer/Titanium	Wear part
11	TE24J539	TE24J539	1	Ball race	Alloy	Wear part
12	<input type="checkbox"/> TE24J310	TE24J310	1	Outer tube, L = 350 mm	Alloy	Spare part
	<input type="checkbox"/> TE24J311	TE24J311	1	Outer tube, L = 500 mm	Alloy	Spare part
	<input type="checkbox"/> TE24J312	TE24J312	1	Outer tube, L = 700 mm	Alloy	Spare part
	<input type="checkbox"/> TE24J313	TE24J313	1	Outer tube, L = 1000 mm	Alloy	Spare part
	<input type="checkbox"/> TE24J314	TE24J314	1	Outer tube, L = 1200 mm	Alloy	Spare part
	<input type="checkbox"/> TE24J315	TE24J315	1	Outer tube, L = 1500 mm	Alloy	Spare part
13	TE20B510	TE20B510	1	Bearing ring	Polymer	Wear part
14	<input type="checkbox"/> TE24J538	TE24J538	1	Inner shaft, L = 350 mm	Alloy	Spare part
	<input type="checkbox"/> TE24J532	TE24J532	1	Inner shaft, L = 500 mm	Alloy	Spare part
	<input type="checkbox"/> TE24J533	TE24J533	1	Inner shaft, L = 700 mm	Alloy	Spare part
	<input type="checkbox"/> TE24J534	TE24J534	1	Inner shaft, L = 1000 mm	Alloy	Spare part
	<input type="checkbox"/> TE24J535	TE24J535	1	Inner shaft, L = 1200 mm	Alloy	Spare part
	<input type="checkbox"/> TE24J536	TE24J536	1	Inner shaft, L = 1500 mm	Alloy	Spare part
15	TE20C511	TE20C511	1	Plain seal	FFKM	Wear part
16	TE24J500	TE24D500	1	Base housing	Alloy	Spare part
17	TE20B512	TE20B512	1	Retaining screw	Stainless steel	Spare part
18	TE20C516	TE20C516	2	Gasket	FFKM	Wear part
19	TE20B514	TE20B514	1	Bearing bush	Polymer	Wear part

Configuration as delivered marked

Please note that some of the polymer parts are in PEEK, which is not resistant to concentrated sulfuric acid.

Available add-on's

Available add-on's regarding material certificates, Declaration of Conformity and Q-Doc documents, see page 46 for more information.

Reference List of Parts (continued)

Toftejorg SaniJet 20 Air Driven, Hastelloy version with improved surface finish (FFKM as standard)

Pos	Item no. for 4" version	Item no. for 3" version	No/ Unit	Description	Material	Remarks
20	TE20B513	TE20B513	1	Bearing bush	Polymer	Wear part
21	TE51T129		1	O-ring	FFKM	Wear part
22	TE24J642		1	Plug	Alloy	Spare part
23	TE24F594		1	Bracket	Stainless steel	Spare part
24	TE20E654		3	Screw	Stainless steel	Spare part
59	TE24J346	TE24J346	1	Motor flange welded A	Alloy	Spare part
60	TE24J340	TE24J340	1	Rotor outer complete	Alloy	Spare part
61	TE24J351	TE24J351	1	Inlet housing 1" Tri-clamp	Alloy	Spare part
62	TE20B343	TE20B343	1	Rotor inner w. magnets	Steel	Spare part
63	TE51C052	TE51C052	1	Tubular rivet	Stainless steel	Spare part
64	TE51T142	TE51T142	1	O-ring	Elastomer	Spare part
65	TE51U392	TE51U392	3	Straight connector	Brass, Nickel-pl.	Spare part
66	TE51U395	TE51U395	1	Flow control valve	Brass, Nickel-pl.	Spare part
67	TE51U393	TE51U393	3	L-connector	Brass, Nickel-pl.	Spare part
68	TE24B557	TE24B557	1	Flange for air motor	Polymer	Spare part
69	TE24B556	TE24B556	1	Adapter for air motor	Polymer	Spare part
70	TE51A096	TE51A096	1	Screw	Stainless steel	Spare part
71	TE51T143	TE51T143	1	O-ring	Elastomer	Spare part
72	TE51B013	TE51B013	6	Washer	Stainless steel	Spare part
73	TE51A097	TE51A097	4	Screw	Stainless steel	Spare part
74	TE24B353	TE24B353	1	Wire for grounding	Stainless steel/alu.	Spare part
75	TE51A112	TE51A112	2	Screw	Stainless steel	Spare part
76	TE51U397	TE51U397	2	Air tubing	Polymer	Spare part
77	TE51U394	TE51U394	2	L-connector	Brass, Nickel-pl.	Spare part
78	TE51U009	TE51U009	1	Air motor		Spare part
79	TE51U396	TE51U396	1	Plug	Brass, Nickel-pl.	Spare part
80	TE51A100	TE51A100	3	Screw	Stainless steel	Spare part
81	TE24B348	TE24B348	1	Motor cover	Stainless steel	Spare part

Configuration as delivered marked

Please note that some of the polymer parts are in PEEK, which is not resistant to concentrated sulfuric acid.

Available add-on's

Available add-on's regarding material certificates, Declaration of Conformity and Q-Doc documents, see page 46 for more information.

Reference List of Parts (continued)

Available add-ons for Spare parts

Item no.	Description
TE2XXXXX-90 or TE2XXXXX-91 or TE2XXXXX-94	<ul style="list-style-type: none"> • Declaration of Compliance: <ul style="list-style-type: none"> - EN 10204 type 3.1 inspection Certificate - FDA Declaration of Compliance - USP Class VI - ADI Declaration
TE2XXXXX-50 or TE2XXXXX-51 or TE2XXXXX-54 Inner shaft pos. no. 14 or Outer pipe pos. no. 12 or Inlet housing pos. no. 61 only	<ul style="list-style-type: none"> • Declaration of Compliance: <ul style="list-style-type: none"> - EN 10204 type 3.1 inspection Certificate - FDA Declaration of Compliance - USP Class VI - ADI Declaration • Weld-Log documentation (if necessary) as hardcopy

Maintenance

Dismantling and reassembling, Cleaner head unit

Dismantling

1. Loosen Cleaner head unit (Pos. 1, 2, 3, 4, 5, 6, 7) with Hook spanner (tool no. TE20B701). Insert carefully into holes in Retaining ring (Pos. 3). Turn counter-clockwise and draw out Cleaner head unit. Never use Pipe wrench or any other tool than the Toftejorg SaniJet 20 special Hook spanner, which is developed especially to protect the surface from being damaged.
2. Remove Seal ring (Pos. 8).
3. Pull off Clip ring (Pos. 6). Push out Pin (Pos. 7).
4. Draw off Bevel gear (Pos. 5) together with Ball ring (Pos. 4) and Retaining ring (Pos. 3).
5. If replacement is necessary, pull off Bearing bush (Pos. 2) from Cleaner head (Pos. 1). The Bearing bush should not be removed unless worn or damaged. Wear on this part will increase leakage flow around the front of the Cleaner head, and accordingly increase the total flow rate.

Reassembling

1. If necessary press new Bearing bush (Pos. 2) fully home onto Cleaner head (Pos. 1).
2. Mount Retaining ring (Pos. 3), Ball ring (Pos. 4) and Bevel gear (Pos. 5) on Cleaner head (Pos. 1).
3. Hold Cleaner head and turn Bevel gear to align the groove over the holes in the Cleaner head. Mount Pin (Pos. 7).
4. Secure with Clip ring (Pos. 6) over Pin (Pos. 7). Check that Pin with Clip ring can move axially.
5. Hold Retaining ring (Pos. 3) and check free rotation of Cleaner head unit.
6. Insert Seal ring (Pos. 8) into Cleaner house on Outer tube. Make sure that it is fitted correctly into recess.
7. Insert Cleaner head unit (Pos. 1, 2, 3, 4, 5, 6, 7) in Outer tube. Correct mounting is made foolproof: Drain hole in Retaining ring must be at the lowest point. Tighten with Hook spanner (tool no. TE20B701).

Caution:



It is important that Seal ring is fitted correctly and that Retaining ring is tightened fully home against "stop". Check that assembly is firmly held in position. If assembly feels loose, replace Seal ring.

Maintenance (continued)

Dismantling and reassembling, Base Unit

Dismantling of Outer tube

In order to dismantle the parts in the Outer tube, it is necessary first to release the Inner shaft (Pos. 14).

Warning:



Retaining screw on side of Base housing (Pos. 16) must never be loosened, when machine is mounted in tank unless down pipe is supported and Pressure line is disconnected, as otherwise the complete Down pipe assembly will fall down.

6. Remove Retaining screw (Pos. 17). Loosen and unscrew with a M10 Hex key (Allen key). Pull out Outer tube (Pos. 12) together with Inner shaft (Pos. 14) from Base housing (Pos. 16).
7. Turn Outer tube upside down. Hold Bevel gear (Pos. 9) and push Inner shaft (Pos. 14) approx. 5 mm into Outer tube. Then rotate Inner shaft $\frac{1}{4}$ revolution, in order for pin in the shaft to pass through grooves in Bevel gear. Remove Bevel gear (Pos. 9) and Ball ring (Pos. 10).
8. Rotate Inner shaft to pass grooves in Ball race (Pos. 11) and pull it out. Tip out Ball race from Outer tube (Pos. 12).
9. If it is necessary to replace Bearing ring (Pos. 13) on Outer tube, pull it off. The Bearing ring should not be removed unless worn or damaged. Wear on this part will increase leakage around Down pipe and accordingly increase total flow rate. It is recommended to replace if diameter is below $\varnothing 38.7$ mm. Diameter must never be below $\varnothing 38.5$ mm.
10. Remove Plain seal (Pos. 15) from Inner shaft (Pos. 14).
11. If necessary, replace Bearing bush (Pos. 20 and 19) in Base housing (Pos. 16).

Reassembling of Outer Tube

12. Mount Plain seal (Pos. 15) on Inner shaft (Pos. 14).
13. Turn Outer tube (Pos. 12) upside down. Fit Ball race (Pos. 11) into Outer tube. Make sure that it is correctly placed in recess.
14. Mount Inner shaft (Pos. 14) from below into the Outer tube. Hold against Ball race (Pos. 11) and fit Inner shaft pin through axial grooves. Place Ball ring (Pos. 10) and Bevel gear (Pos. 9) over Inner shaft on top of the Ball race (Pos. 11). Hold Bevel gear, rotate Inner shaft and draw back to fit pin into groove in the end face of the Bevel gear.
15. Place Base housing (Pos. 16) upside down. Fit upper end of Inner shaft into Base housing. By pressing at the lower end of Inner shaft push the entire assembly into Base housing. Tighten with Retaining screw (Pos. 17).

Maintenance (continued)

Base Unit (continued)

Toftejorg SaniJet 20 (4") is as a standard prepared for monitoring by a Rotacheck Sensor (see Rotacheck System). A Plug (Pos. 22) is fitted in the Base housing in the opening designed for the Rotacheck sensor.

Dismantling of Plug or Rotacheck Sensor

1. Remove Screws (Pos. 24). Loosen and unscrew with a Socket wrench (tool no. TE462A).
2. Remove Bracket (Pos. 23).
3. Press up Plug/Rotacheck (Pos. 22). Remove O-ring (Pos. 21).

Reassembling of Plug or Rotacheck Sensor

16. Insert O-ring (Pos. 21) in hole for Rotacheck on Base housing (Pos. 16). Make sure that it is fitted correctly into O-ring groove inside hole. Insert Plug/Rotacheck (Pos. 22).
17. Place Bracket (Pos. 23) over Plug/Rotacheck.
18. Mount and tighten Screws (Pos. 24) with Socket wrench (tool no. TE462A).

Maintenance (continued)

Air motor Drive unit

Dismantling

1. Push the ring on the push-in fittings and release the compressed air tubes.
2. Remove the 3 pcs Screws (Pos. 80) and take off the Motor cover (Pos. 81).
3. Remove the 4 pcs M5 Screws (Pos. 73) holding the Air motor Drive unit. Loosen and unscrew with a Hex key.
4. The complete Air motor Drive unit can now be removed and taken to the work shop for inspection and maintenance (see page 35).
5. For dismantling the air motor from the motor flange (Pos. 68) first push out the Tubular rivet (Pos. 63) and take off the Rotor inner (Pos. 62). Remove the 2 Screws (Pos. 75) and take off the air motor.

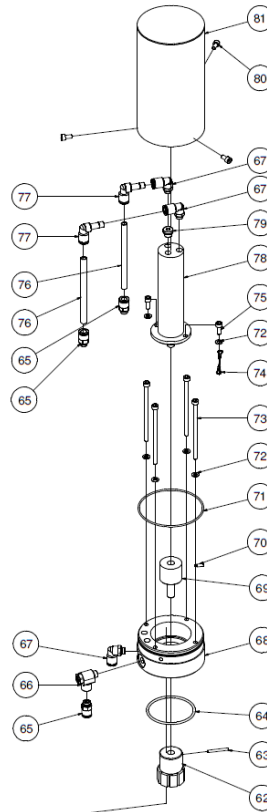
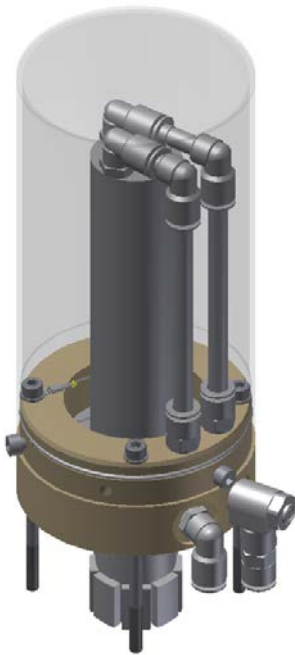

Reassembling

Reassembling is done in the reverse order.

Mount and tighten Screws (Pos. 73) with Hex key. Tighten crosswise. Torque: 3-4 Nm

Caution:



Be careful when reinserting the Rotor with magnets into the cavity in the Motor flange (Pos. 59). Hold Air motor Drive unit firmly and insert slowly. A strong magnetic field is present, which could pull the unit down or to one of the sides and damage the magnets.

Maintenance (continued)

Further Dismantling

1. Lift off the Motor flange (Pos. 59).
2. Remove Gasket (Pos. 18) and lift off Inlet housing (Pos. 61).
3. Withdraw Rotor Outer (Pos. 60).
4. Remove Gasket (Pos. 18) from Base housing (Pos. 16).

Further Reassembling

Before reassembly make sure that all parts are clean without deposits or build-up of foreign matter.

1. Insert Gasket (Pos. 18) in top of Base housing (Pos. 16).
2. Insert the Rotor outer (Pos. 60). Check free rotation.
3. Replace Inlet housing (Pos. 61) on Gasket (Pos. 18) in Base housing (Pos. 16).
4. Mount Gaskets (Pos. 18) into Inlet housing (Pos. 61).

Rotacheck System

The Rotacheck System is an ex-proof system, designed for monitoring the operation of the tank cleaning machine. The Sensor is supplied from a special Relay. The Sensor will send a signal to the Relay each time it is hit by a jet from the rotating tank cleaning machine, thus providing verification that the machine is rotating, of the rotation speed, and that the nozzles are not blocked. To install Rotacheck Sensor simply replace Plug (Pos. 22) with Rotacheck Sensor TE52E067. For further information see Data sheet and operators manual for Rotacheck system.

Trouble Shooting Guide

Symptom: Slow rotation or failure of machine to rotate

Possible Causes	Fault finding
No or insufficient liquid flow	<p>a). Check if supply valve is fully open.</p> <p>b). Check if inlet pressure to machine is correct</p> <p>c). Check supply line/filter for restrictions/ clogging</p> <p>d). Remove Inlet cap (see page 47) and check for clogging in Impeller area.</p> <p>e). Remove Gear ring and Output shaft (see page 47) and check for clogging in Base housing.</p> <p>f). Remove Cleaner head (see page 47) and check Nozzles and Cleaner head for clogging. If blocked, carefully clean without damaging Nozzles vanes and Nozzle tip. Use air pistol.</p> <p>g). Inspect Bevel gear, Ball ring and Bevel gear inside Outer tube (see page 48). If necessary, remove parts and clean.</p> <p>If large particles repeatedly get jammed in the machine, install filter or reduce mesh size of installed filter in supply line.</p>
Foreign material or material build-up	<p>With air pistol blow air through inlet and check that machine rotates evenly. If any resistance is recognised, disassemble machine in order to localise the cause.</p>
a). Impeller jammed	Remove Turbine shaft with Impeller and Planet gear assembly (see page 47) and remove foreign material.
b). Turbine shaft sluggish in Bearings	Remove Turbine shaft with Impeller (see page 47) and clean Bearings.
c). Planet gear jammed/sluggish	Remove foreign material from Planet wheel and Internal gears. Check rotation of Planet wheel. If restriction is recognised, disassemble Planet gear assembly (see page 47) and remove material build up, especially on Shaft and hole in Planet wheel.

Trouble Shooting Guide (continued)

Possible Causes	Fault finding
d). Output shaft jammed/sluggish	Remove Planet gear assembly (see page 47). Turn Down pipe and check unrestricted rotation. Remove Gear ring and Output shaft. Remove foreign material/material build-up on Output shaft, in holes and Bushes in Base housing.
e). Cleaner unit or Bevel gears jammed/sluggish	Rotate again Down pipe. It must rotate freely without any restriction. If not, remove Cleaner unit (see page 47). Clean out any foreign material and material build-up inside Cleaner head in the bottom of the Outer tube. Hold Retaining ring and rotate Cleaner head. If any restriction is recognised, disassemble Cleaner unit and clean all parts. Balls in ball ring must rotate freely.
f). Down pipe jammed/sluggish	If Down pipe still does not rotate freely without any restriction, it must be disassembled. Clean opening in bottom of Base housing and Bearing ring on Outer tube. Remove Bevel gear, Ball ring and Ball race inside Outer tube and clean parts. Balls in Ball ring must rotate freely without any restriction.

Wear

a). Slide bearings	See page 31-36.
b). Bearing for Turbine shaft	See page 31-36
c). Planet wheel	See page 31-36
d). Shaft for Planet wheel	Check clearance of Planet wheel on Shaft. Transverse movement should not exceed 0.3 mm.
e). Turbine shaft	Check clearance in Planet gear, Bearing bush and Bearings for Turbine shaft. Transverse movement should not exceed 0.3 mm. Also inspect teeth for wear.

Mechanical defects

a). Planet wheel. Teeth broken	Replace Planet wheel.
b). Planet wheel can not rotate on Shaft/Shaft bent	Replace Shaft for Planet wheel.
c). Damaged teeth on Bevel gear	Inspect teeth on Bevel gear for deformation. Mount Cleaner Unit in Outer tube (See page 47). Remove Planet gear. Hold Base housing and rotate Down pipe to check that Bevel gears can work together. If damaged: Replace Bevel gears.

Service Kits and Tools

Service Intervals

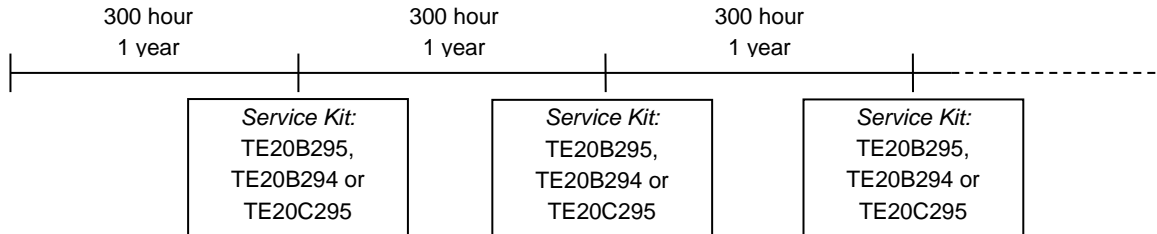

Service Kit in Viton for Toftejorg SaniJet 20 Air driven version

Article no. TE20B294

Reference no.	No.	Description	Pos. no.
TE20B510	1	Bearing ring, top	13
TE20B513	1	Bearing bush D1	20
TE20B514	1	Bearing bush D2	19
TE20B511-01	1	Plain seal S	15
TE20B516-01	2	Gasket D	18
TE20B553-01	1	Seal ring H	8
TE51T008	1	O-ring	21

Service Kit in EPDM for Toftejorg SaniJet 20 Air driven version

Article no. TE20B295

Reference no.	No.	Description	Pos. no.
TE20B510	1	Bearing ring, top	13
TE20B513	1	Bearing bush D1	20
TE20B514	1	Bearing bush D2	19
TE20B511	1	Plain seal S	15
TE20B516	2	Gasket D	18
TE20B553	1	Seal ring H	8
TE51T127	1	O-ring	21

Service Kits and Tools

Service Kit in Perlast for Toftejorg SaniJet 20 Air driven version

Article no. TE20C295

Reference no.	No.	Description	Pos. no.
TE20B510	1	Bearing ring, top	13
TE20B513	1	Bearing bush D1	20
TE20B514	1	Bearing bush D2	19
TE20C511	1	Plain seal S	15
TE20C516	2	Gasket D	18
TE20C553	1	Seal ring H	8
TE51T129	1	O-ring	21

Available add-on's

Available add-on's regarding material certificates, Declaration of Conformity and Q-Doc documents, see page 46 for more information.

Tools

Reference no.	Description
TE462A	8mm Socket Wrench w. pin
TE20B701	Hook spanner

How to Order Spare Parts

On the Part List Drawing page 37 as well as on all instruction drawings, the individual parts have a position number, which is the same on all drawings. From the position number, the part is easily identified in the Reference List of Parts, pages 38-43. Individual parts should always be ordered from the Reference Lists of Parts, clearly stating reference number and description.

Please also quote the type of machine and serial no. This will help us to help you. The serial no. is stamped on the Connection Nipple on the top of the tank cleaning machine.

In cases where spare parts are ordered for machines originally delivered with 3.1 certificates, please state this information on your ordering form together with the machine type and serial number. This is to ensure full traceability henceforward.

In connection with ordering of spare parts for machines originally delivered with Q-doc+FAT-SAT (Qualification Documentation) please note that all service and repair should be performed by Alfa Laval Tank Equipment, Kolding, Denmark, see page 33 "Service and Repair of machines ordered with Q-Doc+FAT-SAT".

How to contact Alfa Laval Tank Equipment

For further information please feel free to contact:

Alfa Laval Tank Equipment

Alfa Laval Kolding A/S

31, Albuen - DK 6000 Kolding - Denmark

Registration number: 30938011

Tel switchboard: +45 79 32 22 00 - Fax switchboard: +45 79 32 25 80

www.toftejorg.com , www.alfalaval.dk - info.dk@alfalaval.com

Contact details for all countries are continually updated on our websites.

EU Declaration of Conformity with ATEX Certification

Only valid for EU countries

EC Declaration of Conformity



The designated company

Alfa Laval Tank Equipment A/S
Company name

Baldershoej 19, DK-2635 Ishoej, Denmark
Address

+45 43 55 86 00
Phone no.

hereby declare that

<u>Tank Cleaning Machine</u> <small>Denomination</small>	<u>Toftejorg SaniJet 20 Air Driven</u> <small>Type</small>
---	---



Valid from SN: 2013 00001 to 2014 10000

is in conformity with the following regulations and directives with amendments:

- **Regulation (EC) No. 1935/2004**
- **FDA 21CFR§177**
- **The Machinery Directive 2006/42/EC**
DS/EN ISO 12100:2010
- **The Pressure Directive 97/23/EC**
According to its own volume and the rated pressure range the product is regarded as Article 3, paragraph 3 Equipment
- **The Equipment Explosive Atmospheres (ATEX) Directive 94/9/EC**
(Applicable for machine certified as category 1 and 2 component, see machine engraving)
DS/EN 1127-1:2011, DS/EN 13463-1:2009, DS/EN 13463-5:2011

SaniJet 20 A, Tank cleaning machine
EC Type Examination Certificate no. Baseefa 05ATEX0117X
Marking: II 1 GD c T140 °C
SGS Baseefa Ltd., Certification body number 1180.
Rockhead Business Park, Staden Lane, Buxton, Derbyshire SK17 9RZ, United Kingdom
The technical construction file is retained at the above address

SaniJet 20 A, Air motor unit
Archive no.: DTI-2013-1-0148A
Marking: II 2 GD c IIC T4 Tamb -20 °C to +40 °C
Archived at Danish Technological Institute, Certification body number 0396, Gregersensvej, 2630 Taastrup, Denmark

<u> </u> <small>Title</small>	<u>Henrik Falster Hansen</u> <small>Name</small>	 <small>Signature</small>
<u>ATEX Responsible Engineer</u> <small>Title</small>	<u>Denniz Hoxbroe</u> <small>Name</small>	 <small>Signature</small>
<u>December 20, 2013</u> <small>Date</small>	<u>Alfa Laval Tank Equipment A/S</u> <small>Company</small>	



Declarations of Conformity per EN 10204 Type 2.2

Only valid for EU countries

Non-Metal Materials
 Impeller, bearings: 21CFR§177.2415 (PEEK450G)
 Gaskets, o-rings: 21CFR§177.2600 (FRKM)
 Ball ring: 21CFR§176.170(C) 1997

Surface Finish
 For item numbers TE24B1XX-XX and TE24G1XX-XX: All parts in contact with media are finished with a nominal internal/external surface roughness Ra = 0.8 µm (30 micro inch).
 For item numbers TE24E1XX-XX and TE24F1XX-XX: All parts in contact with media are finished with a nominal internal/external surface roughness Ra = 0.5 µm (20 micro inch).

Non-Specific Controls on Product Quality "As-Supplied"
 All metallic part material certifications are inspected upon receipt before assembly.
 Parts inspections are completed according to the approved ISO 9001:2008 standard program. The Quality Control Department only accepts the product in component parts for assembly according to this program if the parts comply with the above material specification documentation.
 Product welds are executed, inspected and finished (polished where accessible), according to written, approved procedures.
 Parts produced from FDA approved polymers are only sourced from suppliers that have met "pre-qualification" standards established by Alfa Laval Tank Equipment's ISO 9001:2008 program. Materials of construction of component parts are controlled through clear and explicit specifications in purchase orders. These specifications include the materials of construction specified by the parts designers, making them subject to the contractual terms and conditions.

The following item numbers are covered by this certificate:

TE24B100	TE24B120	TE24B140	TE24B160	TE24G100	TE24G120	TE24G140	TE24G160
TE24B101	TE24B121	TE24B141	TE24B161	TE24G101	TE24G121	TE24G141	TE24G161
TE24B102	TE24B122	TE24B142	TE24B162	TE24G102	TE24G122	TE24G142	TE24G162
TE24B104	TE24B124	TE24B144	TE24B164	TE24G104	TE24G124	TE24G144	TE24G164
TE24B106	TE24B126	TE24B146	TE24B166	TE24G106	TE24G126	TE24G146	TE24G166
TE24B108	TE24B128	TE24B148	TE24B168	TE24G108	TE24G128	TE24G148	TE24G168
TE24E100	TE24E120	TE24E140	TE24E160	TE24F100	TE24F120	TE24F140	TE24F160
TE24E101	TE24E121	TE24E141	TE24E161	TE24F101	TE24F121	TE24F141	TE24F161
TE24E102	TE24E122	TE24E142	TE24E162	TE24F102	TE24F122	TE24F142	TE24F162
TE24E104	TE24E124	TE24E144	TE24E164	TE24F104	TE24F124	TE24F144	TE24F164
TE24E106	TE24E126	TE24E146	TE24E166	TE24F106	TE24F126	TE24F146	TE24F166
TE24E108	TE24E128	TE24E148	TE24E168	TE24F108	TE24F128	TE24F148	TE24F168

Standard	ATEX	Material (rubber antides)
-0X	-7X	EPDM
-01	-71	FFKM (Viton)
-04	-74	FFKM (Peribour)

Copenhagen, Ishøj, on December 20, 2013
 For Alfa Laval Tank Equipment A/S

[Signature]
 Dennis Hoxbroe
 Quality Manager

2/2
 This certificate is delivered in compliance with the latest valid design and construction: Alfa Laval Tank Equipment A/S reserve the right to alter or modify any unit specification without notice or any obligation.
 May 2015

Declaration Of Conformity
 Per
 EN 10204, Sub Clause 2.2 Test Report
 Materials of Construction and Surface Finishes

Alfa Laval Tank Equipment A/S (supplier)
 declare, under our sole responsibility, that the following product:

Description:
 Toftejorg SaniJet20 Air Driven Rotary Jet Head

has been subjected to non-specific controls for product quality and is found to conform with the following standards and other normative documents:

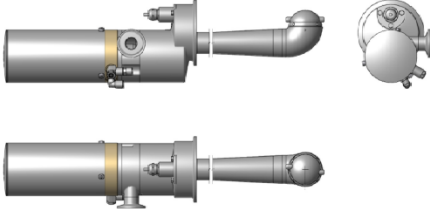

Metal Materials
 In contact with media: AISI 316L Werkstoff no. 1.4404
 Inlet house, cleaner head, shaft and gear wheel: SAF 2205 Werkstoff no. 1.4462
 Ball race: TIGALAV

Metal Materials
 Not in contact with media
 Screws: A4
 Motor cover: AISI 304 Werkstoff no. 1.4301
 Bracket: AISI 316L Werkstoff no. 1.4404

This certificate is delivered in compliance with the latest valid design and construction: Alfa Laval Tank Equipment A/S reserve the right to alter or modify any unit specification without notice or any obligation.
 May 2015

1/2

Declarations of Conformity per EN 10204 Type 2.2

Only valid for EU countries

Non-Metal Materials
 Impeller, bearings: 21CFR§177.2415 (PEEK450G)
 Gaskets, o-rings: 21CFR§177.2600 (FFKM)
 Ball ring: 21CFR§176.170 (C) 1997

Surface Finish
 For item numbers TE24C1XX-XX and TE24H1XX-XX: All parts in contact with media are finished with a nominal internal/external surface roughness Ra = 0.8 µm (30 micro inch).
 For item numbers TE24D1XX-XX and TE24J1XX-XX: All parts in contact with media are finished with a nominal internal/external surface roughness Ra = 0.5 µm (20 micro inch).

Non-Specific Controls on Product Quality "As-Supplied"
 All metallic part material certifications are inspected upon receipt before assembly.
 Parts inspections are completed according to the approved ISO 9001:2008 standard program. The Quality Control Department only accepts the product in component parts for assembly according to this program if the parts comply with the above material specification documentation.
 Product welds are executed, inspected and finished (polished where accessible), according to written, approved procedures.
 Parts produced from FDA approved polymers are only sourced from suppliers that have met "pre-qualification" standards established by Alfa Laval Tank Equipment's ISO 9001:2008 program. Materials of construction of component parts are controlled through clear and explicit specifications in purchase orders. These specifications include the materials of construction specified by the parts designers, making them subject to the contractual terms and conditions.

The following item numbers are covered by this certificate:

TE24C100	TE24C120	TE24C140	TE24C160	TE24H100	TE24H120	TE24H140	TE24H160
TE24C101	TE24C121	TE24C141	TE24C161	TE24H101	TE24H121	TE24H141	TE24H161
TE24C102	TE24C122	TE24C142	TE24C162	TE24H102	TE24H122	TE24H142	TE24H162
TE24C104	TE24C124	TE24C144	TE24C164	TE24H104	TE24H124	TE24H144	TE24H164
TE24C106	TE24C126	TE24C146	TE24C166	TE24H106	TE24H126	TE24H146	TE24H166
TE24C108	TE24C128	TE24C148	TE24C168	TE24H108	TE24H128	TE24H148	TE24H168
TE24D100	TE24D120	TE24D140	TE24D160	TE24J100	TE24J120	TE24J140	TE24J160
TE24D101	TE24D121	TE24D141	TE24D161	TE24J101	TE24J121	TE24J141	TE24J161
TE24D102	TE24D122	TE24D142	TE24D162	TE24J102	TE24J122	TE24J142	TE24J162
TE24D104	TE24D124	TE24D144	TE24D164	TE24J104	TE24J124	TE24J144	TE24J164
TE24D106	TE24D126	TE24D146	TE24D166	TE24J106	TE24J126	TE24J146	TE24J166
TE24D108	TE24D128	TE24D148	TE24D168	TE24J108	TE24J128	TE24J148	TE24J168

Standard: -04 ATEX -74 Material (rubber antisees) PFKM (Perfluor)

Copenhagen, Ishøj, on December 20, 2013
 For Alfa Laval Tank Equipment A/S

[Signature]
 Dennis Høxbroe
 Quality Manager

This certificate is delivered in compliance with the latest valid design and construction. Alfa Laval Tank Equipment A/S reserve the right to alter or modify any unit specification without notice or any obligation.
 May 2013

2/2

Declaration Of Conformity
 Per
 EN 10204, Sub Clause 2.2 Test Report
 Materials of Construction and Surface Finishes

Alfa Laval Tank Equipment A/S (supplier)
 declare, under our sole responsibility, that the following product:

Description:
 Toftejorg SaniJet20 Air Driven Rotary Jet Head, Hastelloy

has been subjected to non-specific controls for product quality and is found to conform with the following standards and other normative documents:

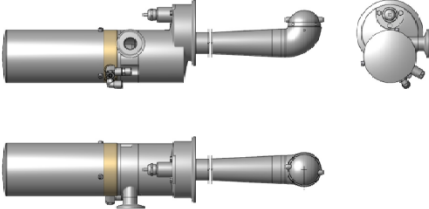

Metal Materials
 In contact with media: Hastelloy C22 Werkstoff no. 2.4602
 Inlet house, cleaner head, shaft, gear wheel and ball race: Hastelloy C276 Werkstoff no. 2.4819
 Balls:

Metal Materials
 No in contact with media
 Screws: A4
 Motor cover: ANSI 304 Werkstoff no. 1.4301
 Bracket: ANSI 316L Werkstoff no. 1.4404

This certificate is delivered in compliance with the latest valid design and construction. Alfa Laval Tank Equipment A/S reserve the right to alter or modify any unit specification without notice or any obligation.
 May 2013

1/2

How to contact Alfa Laval

Contact details for all countries are continually updated on our website.

Please visit www.alfalaval.com to access the information directly.

© Alfa Laval Corporate AB

This document and its contents is owned by Alfa Laval Corporate AB and protected by laws governing intellectual property and thereto related rights. It is the responsibility of the user of this document to comply with all applicable intellectual property laws. Without limiting any rights related to this document, no part of this document may be copied, reproduced or transmitted in any form or by any means (electronic, mechanical, photocopying, recording, or otherwise), or for any purpose, without the expressed permission of Alfa Laval Corporate AB. Alfa Laval Corporate AB will enforce its rights related to this document to the fullest extent of the law, including the seeking of criminal prosecution.